

NeutralPosture

# EQUITY®

PRICE LIST



**2019**  
October



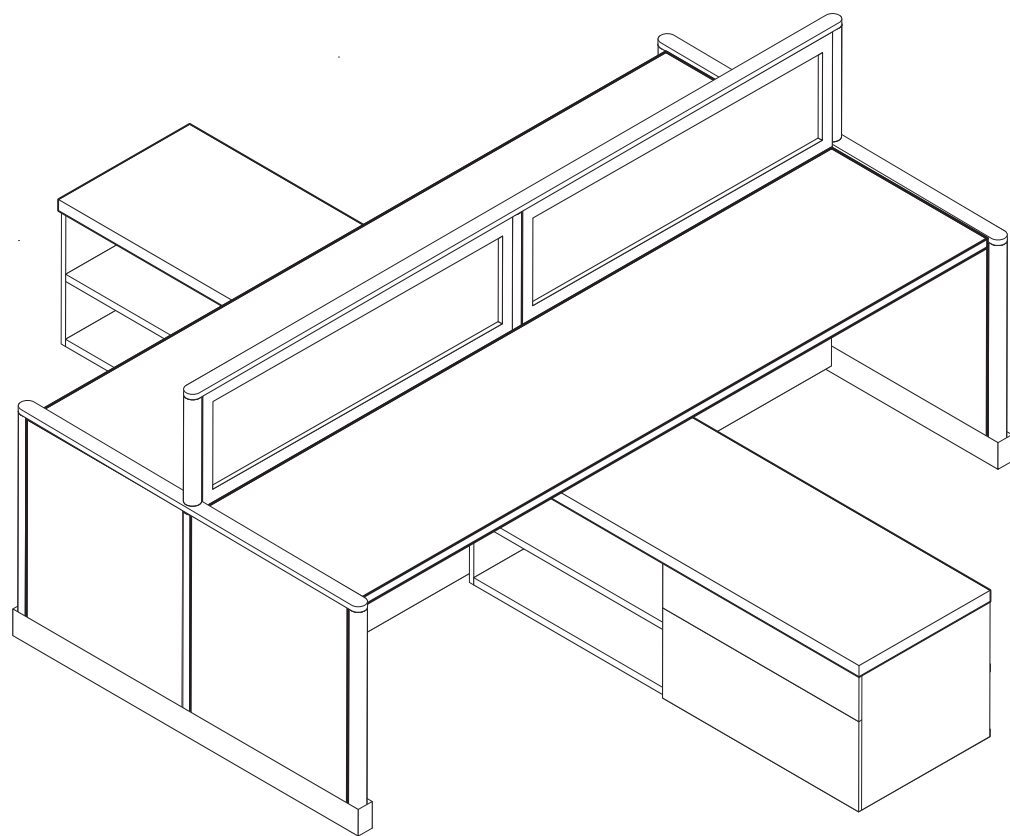

## TABLE OF CONTENTS

<b>GENERAL INFORMATION</b>	<b>4</b>	<b>PANELS</b>	<b>18</b>	<b>WORKSURFACES</b>	<b>70</b>
Panels	4	Features	18	Features	70
Power	4	Construction	18	Wiring & Cabling	70
Raceway	4	Surface Materials	18	Edge Detail	70
Environmental Impact	4	Fabric Panels	20	Surface Materials	70
Storage	4	Insert Panels	22	General Info	72
Legacy Customers	4	Perforated Aluminum Insert Panels	24	Support Information	73
<b>SUSTAINABLE DESIGN</b>	<b>5</b>	Tequity Panels	26	Grain Direction	74
Manufacturing Process	5	Sliding Doors	28	Straights	76
Shipping Initiatives	5	Post Assemblies	30	Corners	78
<b>TERMS AND CONDITIONS</b>	<b>6</b>	End Kits	32	Split Corner	78
Ordering	6	Wall Starter/Wall Mounted Channel	33	Extended Corners	79
Pricing	6	Posts (Multi-height)	34	Corner Peninsulas	80
Taxes	6	Connectors/Shrouds	35	Peninsulas	81
Lead Time	6	<b>STACK-ON PANELS</b>	<b>36</b>	Half Round & Linking	82
Storage Fee	6	Components	36	Blended Double Corner	83
Shipping	6	Stack-on Panel Connectors	36	135° Curved Corner	83
Accessorial Charges	6	Specifying Stack-on	36	Supports	84
Freight Damage	7	Stack-on Diagram	37	Legs	86
Returns	7	Stack-on Configurations	38	Panel Supported Height Adjustable	88
Warranty Claims	7	Fabric with slots	40	Electric Height Adjustable Base	89
Customer's Own Material	7	Fabric without slots	42	120° Planning	90
Delay/Force Majeure	7	Insert with slots	44	120°	92
Compliance with Law	7	Insert without slots	46	Transition Tops	94
Warranty	8	Perforated Aluminum Insert w slots	48	<b>CASCADE WORKSURFACES</b>	<b>95</b>
General Information	8	Perforated Aluminum Insert w/o slots	50	Cascade Edge	95
Key Alike Program	9	Stack-on Posts	52	Straights	96
GSA Contract Overview	10	Panel Accessories	53	Corners & Extended Corners	97
GSA Contract Details	11	Frameless Glass	54	Corner Peninsulas	98
Wall Mounting Suggestions	12	Frameless Glass Connectors	55	Waves	99
Wall Mounting Details	13	Add-on Screens	56	Rounds	100
<b>FINISHES</b>	<b>14</b>	Slat Rail	57	Accessories	101
Fabrics	14	Slat Rail Accessories	57	Personal Drawer	101
Laminates	14	<b>ELECTRICAL</b>	<b>58</b>	<b>COUNTER CAPS</b>	<b>102</b>
Edge Bands	14	How to Order	58	Straights	102
Paints	15	Infeeds	60	Corners	103
Plexiglass	15	Technical Data	61	<b>PANEL SUPPORTED STORAGE</b>	<b>104</b>
Glass	15	Ceiling Infeeds	62	Open Shelves	104
Designer Glass	15	Base Infeeds	63	Overheads	105
Corian	15	Components	64	Shared Storage	106
Textured Corian	15	Knock-out Replacement Cover	64	Tackboards	108
<b>CUSTOM FINISHES PROGRAM</b>	<b>16</b>	Jumper	65	Wall Mounted Channel	109
Customer's Own Fabrics	16	Dedicated Neutral System Components	66	<b>LIGHTING</b>	<b>110</b>
Customer's Own Laminates	16	Dedicated Neutral Jumpers	67	Task Lights	112
Custom RAL Paint Finishes	16	Charge Spot (Wireless Charger)	68	Freestanding Lights	114
<b>LEGACY FINISHES</b>	<b>17</b>	Desktop Data & Power	69	<b>TABLES</b>	<b>116</b>
Legacy – Laminates	17	<b>WORKSURFACES</b>	<b>70</b>	Features	116
Legacy – Edge Bands	17	Features	70	Construction	116
Legacy – Painted & Plastics	17	Wiring & Cabling	70	Surface Materials	116
		Edge Detail	70	<b>OCCASIONAL</b>	<b>118</b>
		Surface Materials	70	Round	118
		General Info	72	Square	119
		Support Information	73	<b>CONFERENCE</b>	<b>120</b>
		Grain Direction	74	Oval	120
		Straights	76	Rectangle	121
		Corners	78	Electric Height Adjustable	122
		Split Corner	78	Pneumatic Height Adjustable	123
		Extended Corners	79	Privacy/Modesty Panels	124
		Corner Peninsulas	80	Mobile Privacy Screens	126
		Peninsulas	81		
		Half Round & Linking	82		
		Blended Double Corner	83		
		135° Curved Corner	83		
		Supports	84		
		Legs	86		
		Panel Supported Height Adjustable	88		
		Electric Height Adjustable Base	89		
		120° Planning	90		
		120°	92		
		Transition Tops	94		
		<b>CASCADE WORKSURFACES</b>	<b>95</b>		
		Cascade Edge	95		
		Straights	96		
		Corners & Extended Corners	97		
		Corner Peninsulas	98		
		Waves	99		
		Rounds	100		
		Accessories	101		
		Personal Drawer	101		
		<b>COUNTER CAPS</b>	<b>102</b>		
		Straights	102		
		Corners	103		
		<b>PANEL SUPPORTED STORAGE</b>	<b>104</b>		
		Open Shelves	104		
		Overheads	105		
		Shared Storage	106		
		Tackboards	108		
		Wall Mounted Channel	109		
		<b>LIGHTING</b>	<b>110</b>		
		Task Lights	112		
		Freestanding Lights	114		
		<b>TABLES</b>	<b>116</b>		
		Features	116		
		Construction	116		
		Surface Materials	116		
		<b>OCCASIONAL</b>	<b>118</b>		
		Round	118		
		Square	119		
		<b>CONFERENCE</b>	<b>120</b>		
		Oval	120		
		Rectangle	121		
		Electric Height Adjustable	122		
		Pneumatic Height Adjustable	123		
		Privacy/Modesty Panels	124		
		Mobile Privacy Screens	126		

<b>STORAGE</b>	<b>128</b>
Accessories Availability	130
Accessories	131
<b>PEDESTALS</b>	<b>132</b>
Features	132
Construction	132
Surface Materials	132
Pedestals	134
<b>FILE CENTERS</b>	<b>136</b>
Features	136
Construction	136
Surface Materials	136
File Centers	138
<b>LATERALS</b>	<b>140</b>
Features	140
Construction	140
Surface Materials	140
Laterals	142
Lateral – BF	143
Lateral – Worksurface Supporting	143
Lateral – Lateral/Open Shelves	143
Lateral – 6B, BBF & BBFF	144
Lateral – Common Tops	145
Lateral – Cushions	145
<b>TOWERS</b>	<b>146</b>
Features	146
Construction	146
Surface Materials	146
24" Wide	148
24" Wide – Side Access	149
15" Wide	150
15" Wide – Side Access	151
<b>CREDENZAS</b>	<b>152</b>
Features	152
Construction	152
Surface Materials	152
Credenzas	154
Accessories	154
Credenza – Drawers	155
Credenza – Shelves	155
Credenza – Common Tops	155
<b>CABINETS</b>	<b>156</b>
Features	156
Construction	156
Surface Materials	156
Cabinets	158
<b>LOCKERS</b>	<b>160</b>
Features	160
Construction	160
Surface Materials	160
Lockers	162
Lockers – Double	163
Lockers – Quad	163
Lockers – Cubby	163
<b>BOOKCASES</b>	<b>164</b>
Features	164
Construction	164
Surface Materials	164
Bookcases	166

<b>WORKPLACE ACCESSORIES</b>	<b>168</b>
Keyboard Trays	170
Keyboard Arms	170
Easy Combos	171
Monitor Arms	172
Monitor Arm Attachments	172
CPU Holders	172
Forearm Supports	173
Anti-fatigue Floor Mats	173
Tablet Holder	173
StandUp	174
StandUp A1	174
StandUp X1	175
<b>GRADED IN FABRICS</b>	<b>176</b>
Carnegie	176
C.F. Stinson	176
DesignTex	177
KnollTextiles	177
Guilford of Maine	177
Luna	178
Maharam	178
Mayer	178
Momentum	179

# General Information

## PANELS

Width dimension of all panels is centerline to centerline of adjacent panel connectors.

Panel thickness is 1½". Panel thickness at the base covers is 2".

### FABRIC PANELS

Fabric panels incorporate a mineral wool core construction. Fabric panels are acoustical and fully tackable. The base raceway is nominally 5" high.

### INSERT PANELS

Insert panels are constructed with a tapered aluminum frame that is mitered in the corners. Insert panels may be ordered with plexiglass, laminate, perforated aluminum or as an open frame for complete accessibility through the panel.

### STACK-ON PANELS

Stack-on panels connect on the top of any standard panel to provide additional privacy or new aesthetic options and can also be load bearing.

### PANEL CONNECTORS

Panel connectors are 1½" diameter and required at every panel connection and panel end (except when postless end assembly is used). Posts are painted to match the selected trim finish and include an adjustable glide on the bottom for leveling.

## POWER

Fabric and insert panels accept electrical components.

Equity panels distribute power through the office and directly to the individual workstation through field-installed modular, electrical wiring components in the base of the panels. The panel base is factory prepared to accept a terminal block in a centered location where two 20-amp receptacles can be installed; one on each side of a panel, arranged back-to-back. An auxiliary side mount duplex receptacle is also available and plugs directly into the side of the terminal block connector end when a second duplex receptacle is required.

## RACEWAY

The panel base cover provides openings for receptacles and/or communication outlets, which can be covered when not in use.

All panel bases provide a cable management segment to facilitate lay-in of workstation cables and cords.

### CABLE CAPACITY

ELECTRICAL FILL	WITH		WITHOUT	
	100%	40%	100%	40%
Cat 5	36	14	102	40
Cat 6	28	11	80	32

## STORAGE

All storage components come standard locking.

Master key and key alike are available upon request.

## LEGACY PRODUCTS

Neutral Posture offers legacy products for existing Equity which was ordered before February of 2016.

For any code compliance testing data, please contact your Customer Service Representative at [customerservice@neutralposture.com](mailto:customerservice@neutralposture.com) or 979.778.0502.

## ENVIRONMENTAL IMPACT

Neutral Posture takes great pride in providing one of the most environmentally friendly furniture systems available on the market today.

Building an effective Green Program takes a company-wide effort, but we think it's worth the effort to ensure that our manufacturing process leaves the smallest possible footprint on the environment. Neutral Posture products are designed and manufactured to support a long and useful product life. Our products, if need be, can withstand repeated service, repairs and handling; and our products are made with standardized parts and components which make replacing worn out parts easy and as green as possible.

The steel and plastic materials used to construct Equity can be recycled after the product's life. The system is also designed to be cleaned with low environmental impact materials.

The clean technology used to manufacture the Equity system results in negligible off-gassing from the product.

We continually work with many 3rd party organizations to firmly establish a quality Sustainability Program.

- BIFMA level® Certification
- SCS Indoor Advantage Gold Certification
- LEED
- Underwriters Laboratories (UL)
- Canadian Standards Association (CSA)
- Occupational Safety and Health Administration (OSHA)
- ISO 9001:2015

## GREEN MANUFACTURING PROCESS

Neutral Posture is highly efficient in its manufacturing process. New roll forming machines can change between parts with zero scrap. The company has also established a 100% solid waste diversion goal for its manufacturing process and is very close to reaching it. Current manufacturing efforts recycle process water and refrain from using hazardous process chemicals.

### PLASTIC

Neutral Posture uses plastic which contains up to 25% pre-consumer recycled plastics. The majority of the plastics used in Neutral Posture products are #3 & #7 plastics and can be recycled in many areas.

### STEEL & ALUMINUM

Neutral Posture products contain steel and aluminum that is 100% recyclable. Additionally, up to 25% of this steel comes from pre-consumer recycled product. Aluminum maintains a high scrap value and is known for having a very long working life.

### FABRIC

Neutral Posture maintains an excellent supply of green fabrics. These fabrics are made from pre- and post-consumer recycled materials. Some fabrics contain 100% recycled materials and continues to divert recycled plastic from landfills, turning it into beautiful designs.

### PANEL INNER

Neutral Posture uses mineral wool, spun from basalt and volcanic rocks to provide lightweight, sound resistant panels. These mineral wool inserts are considered rapidly renewable products.

### WOOD

Wood worksurfaces and panels use 100% recycled/recovered wood fiber. All adhesives used in these products are virtually VOC-free and pass stringent emission standards.

## GREEN SHIPPING INITIATIVES

Neutral Posture holds their freight carrier partners accountable to similar criteria as suppliers, however, due to the immense impact freight companies have on the environment, all carriers must also become a partner in the Environmental Protection Agency (EPA) SmartWay program within one year of service. All freight carriers are screened through a logistics company and become a partner associate with Neutral Posture based on annual evaluation reports.

### PACKAGING OPTIONS

Our cardboard shipping boxes are produced from 45% recycled material and 100% of the materials come from renewable pulp sources. For large orders, customers can choose to use a box made from 100% recycled materials for an upcharge.

### A LONG AND HEALTHY PRODUCT LIFE

Neutral Posture products are made to last, as is evidenced by our limited lifetime warranty. Neutral Posture has been around since the 1980s and it is not unusual to find original products from our first year of production in perfect working condition. Although we are continually improving our products, we allow for retrofitting of earlier generations. This allows the customer to upgrade individual components as desired without having to discard the product they already have or purchase a new one. This helps avoid filling landfills with used furniture and is another way in which Neutral Posture customers contribute to their immediate health and wellbeing as well as the continued wellness of our environment.

For more information about Neutral Posture's sustainable design, visit [NeutralPosture.com/sustainability](http://NeutralPosture.com/sustainability).



---

## TERMS AND CONDITIONS

---

For all non-rated or new accounts, payment terms are Cash in Advance (C.I.A.) until credit has been approved or rated. Please send full credit information and references and allow time for Credit Department approval.

For all established accounts, payment is due within thirty (30) days from the invoice date. Neutral Posture (NP) reserves the right to change or cancel the terms of sale based on volume, credit rating and/or credit information. Prepayment, whole or in part, may be requested at any time at the discretion of the corporate office. For orders greater than \$100,000 net, a fifty percent (50%) deposit is due at the time of order placement, with the remainder due within thirty (30) days of the date of invoice.

Past due accounts are subject to a 1.5% late charge or maximum amount permitted under local law, for each thirty (30) days the outstanding balance remains open after the due date.

Withholding of payments based on carrier damages, shortages or other disputes is illegal and subject to charges.

Neutral Posture does not accept credit cards.

### ORDERING

All orders must be in writing; faxed, e-mailed or mailed. The product model number(s) contained in the order acknowledgment shall be the final expression of the order. A purchase order is not binding on NP until customer has received NP's order confirmation or acknowledgment. Orders must have a contact name and phone number. Orders may not be canceled without written consent of Neutral Posture.

To expedite complete/correct entry of your order, be certain all model numbers, quantities, colors and area identifications are completely specified. Also, include complete purchase order number(s), bill-to and ship-to addresses, a contact name and specific factory shipping dates required.

Orders should be sent to:  
Neutral Posture, Inc.  
3904 N Texas Avenue Bryan, TX 77803  
979.778.0502 (Option 2)  
800.446.3746  
979.778.0408 FAX  
E-mail: [orderentry@neutralposture.com](mailto:orderentry@neutralposture.com)

When an order is received, it is assigned a scheduled ship date. That date is shown on the customer's acknowledgment.

Purchase orders may not be changed or canceled, in whole or in part, without prior written consent of NP. Changes may affect delivery dates. Expenses incurred because of changes shall be charged to customer. In the event of cancellations, customer will be liable for reasonable cancellation charges established by NP. Orders for special product, orders including customer's own material (COM) and orders pursuant to expedited delivery programs, may not be canceled.

A minimum of 3% of net expedite fee will be charged for orders requiring less than standard lead times.

### PRICES

Prices are subject to change without notice. List prices shall be those in effect on the date of receipt of purchase order unless shipment is requested more than ninety (90) days after order entry in which case prices in effect on the date of shipment apply. Prices in effect at time of shipment prevails in the event of a discrepancy.

### TAXES

All sales, use, excise and other taxes applicable to the sale of the products shall be paid by customer. If customer claims an exemption from any tax, customer shall submit to NP the appropriate exemption certificates.

### LEAD TIME

Please contact Customer Service for current lead time at [customerservice@neutralposture.com](mailto:customerservice@neutralposture.com) or 979.778.0502.

### CUSTOMER'S OWN MATERIAL

A customer who requests a fabric or other surface material not standard to NP's line of products (COM), must submit samples of the requested material to NP prior to entry of a customer order. NP shall determine if the material is suitable to its manufacturing processes and meets any requirements of Underwriters Laboratories and/or Canadian Standards Association. If the COM is acceptable, NP will then establish a price for using the COM. For a description of the procedures for submitting samples and testing, contact Customer Service. NP shall have no responsibility for the appearance, condition, performance, durability, colorfastness or any other physical attribute of the COM. Customer shall indemnify and hold NP harmless for any damages, injuries or losses arising out of or related to use of the COM on the product.

### STORAGE FEE

Any changes made by the customer to postpone the delivery date on orders which have already gone into production, will be charged a storage fee. This fee will be applied to both partially and fully built orders. NP will advise of fee prior to applying charge.

### COMPLIANCE WITH LAW

Customer is solely responsible for compliance with all applicable federal, state and local laws, ordinances, regulations, rules and standards relating to the installation, maintenance, use and operation of the products.



---

## TERMS AND CONDITIONS

---

### SHIPPING

Most NP products include shipping. All standard discount orders are F.O.B destination delivered by way of parcel or freight carrier service dock to dock within the forty-eight (48) contiguous United States, and the District of Columbia. NP will designate the shipping mode and carrier based on geographical location and best service as defined by our Logistics Department.

For orders shipping outside the forty-eight (48) contiguous United States, and the District of Columbia, customer pays shipping from port of embarkation to destination and order will be shipped "best way". Customer will incur additional charges if they choose to specify a freight carrier.

Any order requiring special delivery service, other than normal dock to dock delivery, will incur additional charges. These services include, but are not limited to residential delivery, limited access delivery, lift gate service, inside delivery, call before delivery, re-routed deliveries, specific delivery date/time requests or congestion fees. These charges will be quoted at customer request.

Conditions beyond the control of NP, including weather, available facilities and traffic conditions, may affect exact time of delivery. NP shall not be responsible for specific carrier delivery date or time unless it has made a specific delivery commitment, in writing.

Delivery date and time are at the discretion of the carrier within reasonable transit time unless special arrangements have been agreed to in writing between customer and NP prior to shipment.

### Accessorial Charges (Net)

Delivery Apointment Required  
Inside Delivery/Pick Up  
Items Over 96 Inches  
Lift Gate Required  
Limited Access Delivery  
Notification/CBD  
Residential Delivery  
Ship Fully Assembled  
Pre-delivery Notification  
Re-delivery/Return Trip

Contact Customer Service at  
customerservice@neutralposture.com  
or 979.778.0502 for pricing.

### DELAY/FORCE MAJEURE

Neutral Posture shall not be liable for failure to perform or for delay in performance due to fire, flood, strike or other labor difficulty, act of God, act of any governmental authority or of the customer, riot, embargo, fuel or energy shortage, wrecks or delay in transportation, inability to obtain necessary labor, materials or manufacturing facilities from usual sources or failure of suppliers to meet their contractual obligations, or due to any cause beyond its reasonable control. If any such event occurs, Neutral Posture may extend delivery dates by a period of time necessary to overcome the effect of such delay, allocate available product or cancel any purchase order.

### FREIGHT DAMAGE

Upon receipt of shipment consignee is responsible for checking delivery for shortages or signs of damage. If a problem is discovered, bring it to the driver's attention immediately. If any of the goods called for on the Bill of Lading are shorted or damaged, consignees should not accept them until the carrier makes a notation on the freight bill of the shorted or damaged goods. The more precise the notation, the easier the claim can be resolved. NP's responsibility ceases when the consignee signs the freight delivery receipt as received in good condition. Shipping claims must be made within thirty (30) days of shipment delivery.

### RETURNS

The return of product without written authorization by NP shall not be accepted. All merchandise returns must be pre-approved by the corporate office and sent freight prepaid. Contact the Warranty Department, warrantyrequest@neutralposture.com, to receive a Return Merchandise Authorization (RMA) number for any return. RMAs are valid for thirty (30) days and any returned merchandise without a RMA number will be refused.

No deductions from any NP invoices can be made for return merchandise until it is approved by the corporate office. No deductions will be honored until returned goods are processed through our Quality Control Audit.

All returns for canceled orders must be pre-approved by the corporate office and sent freight prepaid. No returns will be authorized unless our inventory allows it, the parts are in good reusable condition and it was sold within the last thirty (30) days. Authorized seating returns will be charged a thirty percent (30%) (twenty percent (20%) for GSA) restocking fee, by agreement, to cover handling, inspection, stocking and repackaging. Authorized systems returns are subject to a forty-five percent (45%) of list restocking charge. Products not currently offered for sale by NP (including COM) shall not be authorized for return. All returned products must be unused, in original condition and in the original NP packing cartons. No refund or credit will be given for damaged products.

### WARRANTY CLAIMS

Neutral Posture reserves the right to specify that items or parts claimed to be defective, be returned to the factory for our inspection. If the claim is justified, repair or replacement of defective parts under warranty will be made through NP at no cost to the customer. NP will, at its discretion, reimburse the furniture dealer for labor (actual costs only) on warranty parts. The furniture dealer must submit a quote to be approved prior to service. If approved, the furniture dealer must then submit an invoice to NP for reimbursement after the service is completed. Freight for products and parts covered under warranty will be covered for the forty-eight (48) contiguous states, and the District of Columbia, with the method of shipping at NP's discretion. All claims must include the product serial number. NP will have no warranty obligation if the product was subjected to abuse, alteration, misuse, negligence or accident or if the user fails to perform the proper maintenance for the product.

# Selling Policy

---

## WARRANTY

---

Neutral Posture warrants to the original purchaser only that the products Neutral Posture manufactures and sells to purchaser are free of defects in workmanship and materials, during the applicable warranty period set forth below.

This comprehensive warranty applies to all products installed or reconfigured by an authorized installer.

Warranty period set forth below is for 24-hour, 7 days a week, multi-shift use. Should any failure occur to a product listed below during the applicable warranty period from the date of shipment, Neutral Posture shall, upon prompt written notice, repair or replace, at its option, the affected part or parts.

### PRODUCT AND PERIOD OF WARRANTY

#### Lifetime

Panels and panel connector parts, high pressure laminate worksurfaces, table tops and common tops, storage, modesty/privacy screens

#### 10 Years

Cascade worksurfaces, height adjustable worksurface supports (except for gas lift), laminate overhead doors, desktop and storage accessories (unless otherwise specified)

#### 5 Years

Table bases, tapered table legs, anti-fatigue mats, operational parts, controls, electrical, lighting (except light ballasts, bulbs and power supply), special or custom product, height adjustable worksurface support gas lift

#### 3 Years

Electric height adjustable bases (including motor), fabric

#### 1 Year

Light ballasts, bulbs and power supply

This warranty does not apply to:

- Damage caused by a carrier.
- Normal wear and tear or acts or omissions of parties other than Neutral Posture (including user modification, improper use or installation of products).
- COM or other third party materials applied to products.
- Products not installed by or under the auspices of a Neutral Posture Dealer.
- Dramatic temperature variations or exposure to unusual conditions.
- Changes in surface finishes including colorfastness due to aging or exposure to light.

The express warranties contained herein are in lieu of all other warranties, express or implied, including any warranties of merchantability and fitness for particular purpose and all other warranties arising from course of dealing or usage of trade.

The remedies provided above are the customer's sole remedies for any failure of Neutral Posture to comply with its obligations regarding the workmanship of its products. Correction of any nonconformity in the manner and for the period of time provided shall constitute complete fulfillment of all liabilities of Neutral Posture, with respect to or arising out of the product furnished hereunder.

---

## CERTIFICATIONS & STANDARDS

---

### ANSI/BIFMA

Independent tests show that Equity components meet or exceed current ANSI/BIFMA X5.6 Panel System and ANSI/BIFMA X5.9 Storage Unit standards. Electrical components are UL listed. Panels have tested to NRC ratings of 0.75.

### SCS INDOOR ADVANTAGE CERTIFICATION

The Equity product line is certified by SCS Global Services for indoor air quality.

### DESIGN

NP reserves the right to make changes and improvements in design and materials and to discontinue parts and components at the discretion of NP.

### WOMEN'S BUSINESS ENTERPRISE (WBE)

This certification is administered by the Women's Business Enterprise National Council (WBENC) and is used by most large corporations to qualify potential vendors as credible diversity suppliers.

### WOMAN OWNED SMALL BUSINESS (WOSB)

The U.S. Small Business Administration's WOSB Federal Contract Program provides greater access to federal contracting opportunities for WOSBs. The program allows contracting officers to set aside specific contracts for certified WOSBs and helps federal agencies achieve the existing statutory goal of five percent of federal contracting dollars being awarded to WOSBs. NP is certified as a WOSB.

### HISTORICALLY UNDERUTILIZED BUSINESS (HUB)

The Texas Historically Underutilized Business (HUB) program encourages the use of HUBs in state procurement and provides information to minority and woman-owned businesses on the state's procurement process.

### BUSINESS AND INSTITUTIONAL FURNITURE

#### MANUFACTURER'S ASSOCIATION

NP is a member of the Business and Institutional Furniture Manufacturer's Association (BIFMA). Tests developed by BIFMA and approved by the American National Standards Institute (ANSI) determine the strength and durability of office furniture in its everyday use. Although this testing does not serve as a warranty or guarantee, NP standard products within this price list meet or exceed applicable ANSI/BIFMA X5.6 Panel Systems and ANSI/BIFMA X5.9 Storage Unit standards. Combinations of options added on to the standard products may not meet ANSI/ BIFMA standards. Those combinations which do not meet ANSI/BIFMA standards are not available on GSA. Additionally, Equity is BIFMA level 2 certified. For more information, contact Customer Service at [customerservice@neutralposture.com](mailto:customerservice@neutralposture.com).

## GENERAL INFORMATION

Neutral Posture pedestals, overheads, and storage cabinets ship with lock cores. The locks are field installed. If your purchase order does not specify key-alike you will automatically receive random lock cores with your order.

Neutral Posture furniture can be keyed-alike or random keyed.

### KEY-ALIKE

Furniture may be keyed alike at no charge. Write "key-alike" in the description of your purchase order for any storage piece you wish to have keyed alike.

Using the key-alike instructions, order cores and keys as line items on your purchase order. Neutral Posture will select key numbers from the standard range of 226 – 425. Key numbers will not be repeated unless over 199 sets are ordered.

There is no charge for key-alike orders if placed with the furniture order.

If product is ordered and shipped random-keyed, additional lock cores for key-alike are billable.

### KEYS

A key is shipped with every lock core. 199 Key numbers are available. For numbers above 199, contact Customer Service. Additional keys and key blanks are available.

### MASTER KEYING

Neutral Posture locks can be controlled by means of a master key. There is no additional per-lock charge for master keying. Master keys must be ordered separately. See service parts for master key model # and pricing.

### INSTALLING LOCK CORES

Lock cores can be installed or removed in the field by using a change key. Cores must be in the unlocked position to be removed. See service parts for change key model number and pricing.

### SERVICE PARTS

MODEL #	DESCRIPTION	LIST
NLCKE_ _ _	Shrouded Key ( <i>Specify key number desired</i> )	\$18
NAKC	Change Key	\$18
NKM	Master Key	\$18

**NOTE: A letter of approval on company letterhead from the client must accompany all orders for change and master keys.**

**NOTE: Neutral Posture locks/keys are not compatible with Knoll Equity pedestals/double pedestals.**

## HOW TO SPECIFY KEY-ALIKE

Following is an example of how to specify key-alike for a cluster of 10 workstations.

### STEP 1

Using the project floor plan, count the number of locks in each workstation.

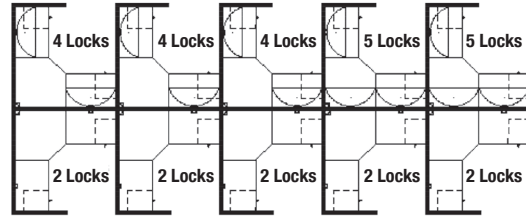

### STEP 2

Count the number of workstations with the same quantity of locks. Group together the workstations with a like number of locks.

- 5 workstations with 2 locks per station
- 3 workstations with 4 locks per station
- 2 workstations with 5 locks per station

### STEP 3

For the first group (5 sets of 2 locks), enter the number of workstations in the quantity column.

QTY	MODEL #	DESCRIPTION	UNIT LIST	EXT LIST
5	NSPEC 2	Set of 2 cores/keys	N/C	N/C

### STEP 4

Then enter the model number "NSPEC\_ \_" and add a suffix for the number of locks for that group (i.e., for 2 locks per station, add the suffix "2"). Up to 30 lock cores are available in a set (i.e., NSPEC 30).

QTY	MODEL #	DESCRIPTION	UNIT LIST	EXT LIST
5	NSPEC 2	Set of 2 cores/keys	N/C	N/C

### STEP 5

Repeat for other groups.

QTY	MODEL #	DESCRIPTION	UNIT LIST	EXT LIST
5	NSPEC 2	Set of 2 cores/keys	N/C	N/C
3	NSPEC 4	Set of 4 cores/keys	N/C	N/C
2	NSPEC 5	Set of 5 cores/keys	N/C	N/C

Your key instructions are complete.

Neutral Posture will select key numbers for each set from 199 available numbers.

For additions to existing installations, specify desired key numbers in the description.

# GSA Contract Overview

## GSA CONTRACT

We have had a contract with GSA for over 20 years and they continue to be our most favored customer.

NP is dedicated to helping government agencies meet their facilities and acquisition needs. NP is registered with the System For Award Management (SAM) formerly Central Contractor Registry (CCR) with ORCA certifications, has an assigned cage code of OUTL8 and is eligible to receive federal contract awards. NP is also recognized as a Woman Owned Small Disadvantaged Business by the U.S. Small Business Administration (SBA).

## WOMEN-OWNED SMALL BUSINESS (WOSB)/ ECONOMICALLY DISADVANTAGED WOMEN- OWNED SMALL BUSINESS (EDWOSB)

The U. S. Small Business Administration (SBA) issued the Final Rule to amend its regulations governing small business contracting procedures. The SBA has increased the emphasis and awareness of contracting mandates regarding the new 5% spend mandate for WOSB/EDWOSB's similar to those in place for 8a, SDV and HUB Zone businesses.

The SBA has also implemented a Sole Source vehicle for Economically Disadvantaged Women-Owned Small Businesses (EDWOSB). Neutral Posture, a small business manufacturer, received this certification in April of 2016.

Our Packaged Office contract includes many great manufacturing partners and we are willing to team with other manufacturers to support strong GSA Dealers and meet the needs of our customers.

For more information please visit  
[NeutralPosture.com/WOSB](http://NeutralPosture.com/WOSB)

## GSA OVERVIEW

GSA Contract# GS-27F-0014Y

### Schedule 71 – Furniture

SIN 71-1	Packaged Office
SIN 71-205	Chairs-Dining Room, Desk, Side, Period Style and Bar Stools
SIN 711-1	Furniture Systems and Workstation Clusters
SIN 711-11	Tables and Accessories
SIN 711-18	Multipurpose Seating
SIN 711-19	Stacking Chairs and Dollies
SIN 711-2	Worksurfaces, Workstations, Computer Furniture and Accessories
SIN 711-3	Filing and Storage Cabinets, Shelves, Mobile Carts, Dollies, Racks & Accessories
SIN 711-91	Project Management (Furniture Related)
SIN 711-94	Office Design/Layout Services
SIN 711-95	Installation services
SIN 71-500	Order-level Materials (OLMs)

## NAICS CODES

337214	Office Furniture (except wood) Manufacturing
337211	Wood Office Furniture Manufacturing
337127	Institutional Furniture Manufacturing
423210	Furniture Merchant Wholesalers

NP products may be found on GSA Advantage.

**TERM DATE 6/26/2012 – 6/26/2022**

- 1a. Special Item Numbers Awarded**
- SIN 711-1 Furniture Systems and Workstation Clusters
  - SIN 711-11 Tables and Accessories
  - SIN 711-18 Multipurpose Seating
  - SIN 711-19 Stacking Chairs and Dollies
  - SIN 711-95 Installation Services
  - SIN 711-2 Worksurfaces, Workstations, Computer Furniture and Accessories
  - SIN 711-3 Filing and Storage Cabinets, Shelves, Mobile Carts, Dollies, Racks & Accessories
  - SIN 711-91 Project Management (Furniture Related)
  - SIN 711-94 Office Design/Layout Services
  - SIN 71-1 Packaged Office
  - SIN 71-205 Chairs-Dining Room, Desk, Side, Period Style and Bar Stools
  - SIN 71-500 Order-level Materials (OLMs)

- 1b. Lowest Priced Item**
- SIN 71-1 Call Corporate Office
  - SIN 71-205 Call Corporate Office
  - SIN 711-1 EP3P29 Single Post ..... \$32.55
  - SIN 711-11 TBR30X-L1/P1 Round Table ... \$337.50
  - SIN 711-18 NCUGG1 Urethane ..... \$151.20
  - SIN 711-19 NSID115 Grade C ..... \$336.00
  - SIN 711-2 11 Keyboard Tray ..... \$65.10
  - SIN 711-3 SPTRY Pencil Tray ..... \$5.95
  - SIN 711-95 Not Applicable
  - SIN 71-500 Not Applicable

- 1c. Installation Rate — SIN 711-1, 711-3, 711-11**  
 \$51.50 per hour (non-union inclusive IFF)  
 \$106.25 per hour (union inclusive of IFF)
- Project Management Fee — SIN 711-91**  
 Senior Project Manager \$75 per hour (inclusive IFF)  
 Project Manager \$55.58 per hour (inclusive IFF)  
 Project Coordinator \$50 per hour (inclusive IFF)

**Design/Layout Fee — SIN 711-94**  
 \$65 per hour (inclusive IFF)  
 \$85 per hour CADD service (inclusive IFF)

- 2. Maximum Order**
- SIN 71-1 ..... \$5,000,000
  - SIN 71-205 ..... \$1,000,000
  - SIN 711-1 ..... \$500,000
  - SIN 711-11 ..... \$500,000
  - SIN 711-18 ..... \$200,000
  - SIN 711-19 ..... \$200,000
  - SIN 711-2 ..... \$200,000
  - SIN 711-3 ..... \$500,000
  - SIN 711-91 ..... \$150,000
  - SIN 711-94 ..... \$150,000
  - SIN 711-95 ..... \$150,000
  - SIN 71-500 ..... \$0

- 3. Minimum Order**  
 All SINs ..... \$50

- 4. Geographic Coverage**  
 CONUS & OCONUS

- 5. Point of Production**  
 3904 N. Texas Avenue, Bryan, Brazos County, Texas, USA

- 6. Discount from List Price**

**Seating/Workplace Accessories**  
 SIN 711-2, 711-18, 711-19, 711-205 — Discount 58%

**Systems**  
 SIN 711-1, 711-3, 711-11 — Discount 70%

- 7. Quantity Discounts**  
 No discount tiers have been negotiated.

- 8. Prompt Payment Terms**  
 Net 30 Days

- 9. Government Purchase Cards Accepted**  
 Visa/Master Card

- 10. Foreign Item**  
 None

- 11a. Time of Delivery**  
 5 – 90 days after receipt of order

- 11b. Expedited Delivery**  
 Expedited delivery available. Contact NP Customer Service.

- 11c. Overnight and 2-day Delivery**  
 Available with an upcharge. Contact NP Customer Service.

- 12. F.O.B. Points**  
 Destination/CONUS, within the 48 contiguous states and the District of Columbia. Port of embarkation for delivery to Alaska, Hawaii, Puerto Rico, the Virgin Islands and U.S. Government installations overseas.

- 13. Ordering Address**  
 Neutral Posture, Inc.  
 attn: Order Entry/ \* or dealer  
 3904 N. Texas Avenue  
 Bryan, TX 77803  
 979.778.0502  
 800.446.3746  
 fax 979.778.0408  
 orderentry@neutralposture.com  
 \* Authorized Dealers should be cited on order

- 14. Payment Address**  
 Neutral Posture, Inc.  
 3904 N. Texas Avenue  
 Bryan, TX 77803

- 15. Warranty Provision**  
 Neutral Posture's commercial warranty applies.

- 16. Export Packing Charges**  
 Contact NP Customer Service for quote.

- 17. Terms and Conditions of Government Purchase Card**  
 Government purchase cards will be accepted for purchases at prices shown in this authorized price list (no additional discount offered).

- 18. Terms and Conditions Of Rental, Maintenance, and Repair**  
 Not applicable

- 19. Terms and Conditions of Installation**  
 Installation and instruction are available from authorized dealers. Please contact your local NP Dealer for pricing.

- 20. Terms and Conditions of Repair Parts**  
 Repair parts are offered at the agreed upon discount from the NP repair parts price list in effect at the time the repair parts are ordered.

- 20a. Terms and Conditions for Any Other Services**  
 GSA has accepted all of our standard terms and conditions as noted on page 6-8.

- 21. List of Service and Distribution Points**  
 Not applicable

- 22. List of Dealers**  
 Please contact NP, or visit NeutralPosture.com for the name of your nearest authorized Dealer.

- 23. Preventive Maintenance**  
 Not offered or applicable

- 24. Environmental Attributes**  
 Not applicable

- 25. Other Information**
- |                                  |            |
|----------------------------------|------------|
| Tax Identification Number (TIN): | 74-2983577 |
| DUNS:                            | 61-0339723 |
| Cage Code:                       | OUTL8      |
| NAICS:                           | 337214     |

- 26. SAM**  
 NP is registered in System For Award Management (SAM).

**NOTE:** It is mandatory that all Government purchase orders be made out to NP only. Local Dealers are not authorized to accept purchase orders, issue invoices or receive payment of Government funds for these items without serious violation of this Federal Supply Schedule Contract.

---

## WALL MOUNTING SUGGESTIONS

---

The following information is provided only as a guide, and represents minimum recommendations only. Neutral Posture does not accept responsibility for the attachment of any Neutral Posture product to a Customer's site wall. Wall specification/construction is the responsibility of the Customer and its structural engineer/architect. Failure to properly attach Neutral Posture products to adequate wall structures can lead to property damage and/or personal injury.

You should consult your own structural engineers and/or architects and must not rely on the information provided herein.

It is the responsibility of the Customer and its structural engineers/architects to verify that the permanent structural walls (studs, blocks, solid masonry, etc.) on which the

Neutral Posture products are intended to be mounted are designed appropriately to support the product weight, PLUS 3 lbs. per linear inch for each usable shelf length.

NOTE: A cabinet's top is considered a "usable shelf" and MUST be included in the calculation of the total load for an overhead cabinet.

It is the responsibility of the Customer and its structural engineer/architects to specify the fasteners and method for attaching the Neutral Posture supplied wall mounting cleat, bracket, frame, etc. to the supporting wall and to confirm that the installers have adhered to these specifications. For all local building standards and codes, and additional requirements (including, but not limited to, seismic conditions) the Customer should always consult local code agencies.

## New Construction

## Existing Construction

	Cinder Block or Poured Concrete Masonry Wall	Wood Stud Wall, the studs being <b>FULL HEIGHT</b> to the roof/floor above	Wood Stud Wall, the studs being only ceiling height	Steel Stud Wall, the studs being <b>FULL HEIGHT</b> to the roof/floor above	Steel Stud Wall, the studs being only ceiling height	
<b>Stud Specification</b>	Wood studs, grade #2 or better, 3 1/2" minimum width, OR Metal studs, minimum 25 gage thickness, 3 5/8" minimum width	The wall must be a minimum of 6" thick, and must be full height to the roof/floor structure above	Wood studs must be Grade #2, or better, 3 1/2" minimum width	Wood studs must be Grade #2, or better, 3 1/2" minimum width	Metal studs must be minimum 25 gage thickness, 3 5/8" minimum width	
<b>Stud Centers</b>	Metal and wood studs must be spaced at 16" c/c maximum.	N/A	Wood studs must be spaced at 16" c/c maximum.	Wood studs must be spaced at 16" c/c maximum.	Metal studs must be spaced at 16" c/c maximum.	
<b>Stud Height</b>	Metal and wood studs must extend upwards, and be securely attached to the roof/floor structure above.			Wood studs must be braced above the ceiling, and be securely attached to the roof/floor structure above. Affix #2 grade 'cap' across the top of the studs, then place diagonal studs from the top cap up to underside of the roof/floor structure above.		
<b>Mounting the Neutral Posture Supplied Cleat, Bracket, Frame, etc</b>	<p>Insert a 2" x 6" wood block, #2 grade or better, [or a locally approved flexible wood backing system] horizontally between each of the studs to accommodate the full width of the cabinet and beyond to the next stud.</p> <p>Fasten the wood block to each stud using three screws at the ends of each block.</p> <p>(Fasten the locally approved wood backing system as directed by the manufacturer.)</p> <p>Fasten the Neutral Posture supplied wall mounting cleat, bracket, frame, etc directly to each wood block every 6".</p> <p>For wall mounting structures that have a rectangular frame-like configuration: fasten the top horizontal element of the frame to the wood blocking every 6" and fasten the lower horizontal element to each wall stud, using one fastener per stud.</p>	<p>Fasten the Neutral Posture supplied cabinet wall mounting cleat, bracket, frame, etc. directly to the masonry wall every 6".</p> <p>For wall mounting structures that have a rectangular frame-like configuration: fasten the top horizontal element of the frame to the wall every 6" and fasten the lower horizontal element to the wall every 16".</p>	<p>In the desired location of the cabinet mounting rail, remove an 8" high section of drywall the width of the cabinet and beyond to the next stud.</p> <p>Insert a 2" x 6" wood block, #2 grade or better, horizontally between each of the exposed studs.</p> <p>Fasten the wood block to each stud using three screws at the ends of each block.</p> <p>Replace the drywall and repair as desired.</p> <p>Fasten the Neutral Posture supplied wall mounting cleat, rail, frame, etc directly to the wood block every 6".</p> <p>For wall mounting structures that have a rectangular frame-like configuration: fasten the top horizontal element of the frame to the wood blocking every 6", and fasten the lower horizontal element to each wall stud, using one fastener per stud.</p>	<p>In the desired location of the cabinet mounting rail, remove an 8" high section of drywall the width of the cabinet and beyond to the next stud.</p> <p>Insert a 2" x 6" wood block, #2 grade or better, horizontally between each of the exposed studs.</p> <p>Fasten the wood block to each stud using three screws at the ends of each block.</p> <p>Replace the drywall and repair as desired.</p> <p>Fasten the Neutral Posture supplied wall mounting cleat, rail, frame, etc directly to the wood block every 6".</p> <p>For wall mounting structures that have a rectangular frame-like configuration: fasten the top horizontal element of the frame to the wood blocking every 6", and fasten the lower horizontal element to each wall stud, using one fastener per stud.</p>	<p>In the desired location of the cabinet mounting rail, remove an 8" high section of drywall the width of the cabinet and beyond to the next stud.</p> <p>Insert a 2" x 6" wood block, #2 grade or better, [or a locally approved flexible wood backing system] horizontally between each of the exposed studs.</p> <p>Fasten the wood block to each stud using three screws at the ends of each block.</p> <p>Replace the drywall and repair as desired.</p> <p>Fasten the Neutral Posture supplied wall mounting cleat, rail, frame, etc directly to the wood block every 6".</p> <p>For wall mounting structures that have a rectangular frame-like configuration: fasten the top horizontal element of the frame to the wood blocking every 6", and fasten the lower horizontal element to each wall stud, using one fastener per stud.</p>	<p>In the desired location of the cabinet mounting rail, remove an 8" high section of drywall the width of the cabinet and beyond to the next stud.</p> <p>Insert a 2" x 6" wood block, #2 grade or better, [or a locally approved flexible wood backing system] horizontally between each of the exposed studs.</p> <p>Fasten the wood block to each stud using three screws at the ends of each block.</p> <p>Replace the drywall and repair as desired.</p> <p>Fasten the Neutral Posture supplied wall mounting cleat, rail, frame, etc directly to the wood block every 6".</p> <p>For wall mounting structures that have a rectangular frame-like configuration: fasten the top horizontal element of the frame to the wood blocking every 6" and fasten the lower horizontal element to each wall stud, using one fastener per stud.</p>
<b>Fasten the Neutral Posture Supplied Wall Cleat With...</b>	#10 x 2 1/2" wood screws or equiv. in every mounting hole provided, screwed directly into the wood blocking	3/16" x 3 1/2" masonry screws or equiv. in every mounting hole provided with 1 1/4" embedment, screwed directly into the masonry wall	#10 x 2 1/2" wood screws or equiv. in every mounting hole provided, screwed directly into the wood blocking	#10 x 2 1/2" wood screws or equiv. in every mounting hole provided, screwed directly into the wood blocking	#10 x 2 1/2" wood screws or equiv. in every mounting hole provided, screwed directly into the wood blocking	



# Finishes

## FABRICS

### A

Cross Check	Mayer	F299
Forte	Mayer	F298
Quattro	Mayer	F300
Strata	Mayer	F164

### B

Cape Cod	Guilford of Maine	F3073
Grasscloth	Mayer	F137
Luminary	Mayer	F100
Metallation	Guilford of Maine	F5118
Metro	Guilford of Maine	F3077
Sprite	Guilford of Maine	F2671
Tweed	Guilford of Maine	F2737

### C

Rattan	Guilford of Maine	F3087
Reverb	Mayer	F421

### D

Echo	Mayer	F388
Pact	Momentum	F0911

### E

Infinity	Momentum	F0914A
Marathon	Momentum	F0914B
Millennium	Momentum	F0914C
Odyssey	Momentum	F0914D
Tradition	Momentum	F0914E
Verse	Momentum	F0910

## LAMINATES

### L1

Casual Linen	SS-CLN
Grey Mesh	SP-GRM
Linen	SS-LN
Mangalore Mango	SW-MGM
Mission Maple	SW-MNM
Nickle Ev	SS-NEV
Organic Cotton	SS-OC
Soft Gold Mesh	SP-SGM
Sterling Ash	SW-STA

### L2

Asian Sand	PW-ASD
Astro Strandz	PP-AST
Biltmore Cherry	PW-BCH
Cosmic Strandz	PP-CST
Empire Mahogany	PW-EMH
Fired Steel	PP-FIS
Forged Steel	PP-FOS
Shaker Cherry	PW-SCH
Silver Alchemy	PW-SAL
Studio Teak	PW-STK
Vapor Strandz	PP-VST

## EDGE BANDS

Asian Sand	EB-ASD
Astro Strandz	EB-AST
Beige	EB-BEI
Biltmore Cherry	EB-BCH
Casual Linen	EB-CLN
Cosmic Strandz	EB-CST
Custom Laminate	EB-COL
Empire Mahogany	EB-EMH
Fashion Grey	EB-FGR
Fired Steel	EB-FIS
Forged Steel	EB-FOR
Grey	EB-GRY
Grey Mesh	EB-GRM
Khaki Brown	EB-BRN
Linen	EB-LN
Mangalore Mango	EB-MGM
Mission Maple	EB-MNM
Nickle Ev	EB-NEV
Organic Cotton	EB-OC
Pepperdust	EB-PPR
Platinum	EB-PLT
Sand	EB-SND
Shadow	EB-SHD
Shaker Cherry	EB-SCH
Silver Alchemy	EB-SAL
Slate Grey	EB-SGR
Soft Gold Mesh	EB-SGM
Sterling Ash	EB-STA
Studio Teak	EB-STK
Vapor Strandz	EB-VST
Virtual Design Laminate	EB-VL

**NOTE: Laminates and other finishes may vary in color due to different dye lots. Slight variations are normal.**

## PAINTS

### P1

Cream	201T
Designer Beige	202T
Grey	203T
Jet Black	204T
Sky White	200T

### P2

Brass	303
Champagne	301
Platinum	302

## PLEXIGLASS

Clear	CL
Ice	IC
Smoked	SM
Translucent	TR

### NOT AVAILABLE ON INSERT PANELS

Frost	LF
-------	----

## GLASS

Clear	CL
Grey	GR
Smoked	SM
Translucent	TR

## DESIGNER GLASS

Patterns from Skyline Design.  
Some exceptions apply.

There is a minimum \$500 set-up and crating fee for all designer glass orders. Please call customer service for a quote 979.778.0502 ext 301.

## CORIAN

Glacier White	CR001
Pearl Grey	CR002
Corian Clay	CR003
Silver Grey	CR004
Corian Grey	CR005

## TEXTURED CORIAN

Glacier White	CR001T
Pearl Grey	CR002T
Corian Clay	CR003T
Silver Grey	CR004T
Corian Grey	CR005T

# Custom Finishes Program

While Neutral Posture offers a large selection of unique finishes, we understand you might want to create a signature on your project or brand your project. We are offering an easy way for you to provide pricing to your client.

---

## CUSTOMER'S OWN FABRIC

---

Neutral Posture can apply any UL fire rated fabric. This will add to the lead time as we will require three yards of fabric to test on a panel. Test yardage should be sent to the factory address in Bryan, TX with the project name clearly marked on the label noting test yardage.

Neutral Posture Test Fabric  
Attention: Systems Product Manager  
3904 N. Texas Ave.  
Bryan, TX 77803

We can also grade-in any fabric from any supplier in the industry. Please contact your sales representative or Customer Service for grade-in pricing. Note that all grade-ins must be pre-approved for suitability before production begins.

---

## CUSTOMER'S OWN LAMINATE

---

All of Neutral Posture's standard laminates are Wilsonart. For your project, you can select any Wilsonart laminate and use L1 for standard laminates, L2 for premium laminates and L3 for custom and virtual library programs. An upcharge may apply for matching edge banding. Please contact your sales representative or Customer Service for more information.

We can also grade-in any laminate from any other supplier. Please contact your sales representative or Customer Service for grade-in pricing. Note that all grade-ins must be pre-approved for suitability before production begins.

---

## CUSTOM RAL PAINT FINISHES

---

Whether it is an 8 person or 1,000 person project, use any RAL powder coat color on your metal products. If you have any questions, please contact your sales representative or Customer Service for more information.

### HOW TO PRICE

#### For Each Order

Setup fee per RAL color ..... \$1,100 (NET)  
Each item using an RAL color ..... P3 Pricing

# Legacy finishes are only available for existing customers to match existing installs

## LEGACY – LAMINATES

### L1

Jet Black	111
Folkstone Grey (was LA)	114
Soft Grey (was M42)	117
Bright White	118
Pumice (was LF)	119
Micro Grey	121
Brushed Sand	122
Brushed Grey	123
Medium Cherry	124
Natural Maple	125
Natural Cherry	126
Walnut	127
Fog	128
Micro Sand	129
Caramel Maple	MC
Clear Maple	CM
Deep Mahogany	MP58
Grey Granite	M95
Light Oak	MP70
Pearwood	PA
Rose Granite	M96
Sand	SD
Med. Grey (Slate)	M89
Taupe	M80
Warm Cherry	WM
White Essence	ES7
Winter Grey Matrix	MR6

## LEGACY – EDGE BANDS

Jet Black	111
Dark Grey (was Y3)	113
Folkstone Grey (was LA)	114
Medium Grey (was Y2)	115
Soft Grey (was E)	117
Bright White	118
Pumice (was LF)	119
Medium Cherry	124
Natural Maple	125
Natural Cherry	126
Walnut	127
Fog	128
Dark Neutral	D
Taupe	R
Sand	SD
Caramel Maple	MC
Clear Maple	CM

## LEGACY – PAINTS & PLASTICS

### P1

Jet Black	111
Brown	112
Dark Grey (was Y3)	113
Folkstone Grey (was LA)	114
Med. Grey (was Y2)	115
Sandstone	116
Soft Grey (was E)	117
Dark Neutral	D
Taupe	R

### P2

Beige Mist Metallic	611
Medium Metallic Grey	612
Beige Metallic	H
Light Tan Metallic	W

### P3

Bright White	118
Silver	613

**NOTE: EP1 and EP2 panels and components are not available in the following:**

Bright White	118
Brown	112
Jet Black	111

# Panels

## General Info

### Step 1 – Model #

EP	Equity Panel	3	Beveled	FA	Fabric Panel	36	29	K	Raceway
		N	Flat					N	with knockouts without knockouts
EP		N		FA		36	29	K	

### Step 2 – Surface Finish

F298	Forte
F298	

### Step 3 – Trim Finish

301	Champagne
301	

## FEATURES

### HEIGHTS

29" H  
36" H  
41" H  
49" H  
54" H  
61" H  
66" H  
81" H

### WIDTHS

12" W  
18" W  
24" W  
30" W  
36" W  
42" W  
48" W  
60" W

### THICKNESS

1 1/2"

### TOP CAP

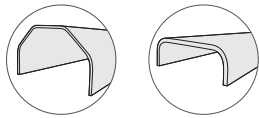

3 – Beveled

N – Flat

### RACEWAY

(K) with knockouts  
(N) without knockouts

### PANEL RATINGS

NRC	.75
STC	15

## CONSTRUCTION

### FABRIC PANEL FRAME

Galvaneal roll formed steel frame

### FABRIC PANEL CORE

Mineral wool  
Fiberglass backer

### INSERT PANEL FRAME

Extruded aluminum

### INSERT PANEL CORE

1/4" Laminate  
1/4" Perforated aluminum  
1/4" Plexiglass  
Open Frame

### TOP CAP, SLOTTED STANDARD

Cold rolled roll formed steel

### TOP CAP CLIP

Spring steel

### RACEWAY COVER, RACEWAY BASE & RACEWAY RETENTION CHANNEL

Cold rolled roll formed steel

### RACEWAY STANCHIONS

Pressed & folded steel

### PANEL HOOKS

Steel

### POSTS

Steel tube

### POST CONNECTORS

Diecast aluminum

### SHROUDS

Pressed & folded steel

## SURFACE MATERIALS

### ALL PANELS

Trim – paint

### FABRIC PANELS (FA)

Fabric

### INSERT PANELS

#### Plexiglass (PG)

Clear	CL
Ice	IC
Smoked	SM
Translucent	TR

#### Glass (GL)

Clear	CL
Grey	GR
Smoked	SM
Translucent	TR

#### Designer Glass (DG)

Patterns from Skyline Design.  
Some exceptions apply.

There is a minimum \$500 set-up and crating fee for all designer glass orders. Please call customer service for a quote 979.778.0502 ext 301.

#### Laminate (LM)

Laminate

#### Perforated Aluminum (PA)

Paint

#### Open Frame (OF)

Paint

### POSTS, CONNECTORS & SHROUDS

Paint

# PANELS

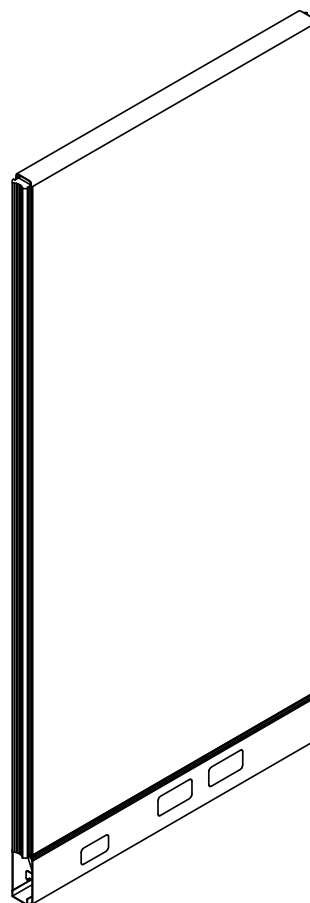

# Fabric Panels

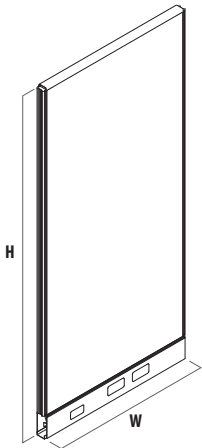

## 29" H

W	MODEL #	FABRIC								PAINT	
		A	B	C	D	E	F	G	H	P2	P3
12"	EP(3/N)FA1229(K/N)	\$430	\$460	\$500	\$550	\$610	\$680	\$760	\$850	+ \$25	+ \$50
18"	EP(3/N)FA1829(K/N)	\$480	\$510	\$550	\$600	\$660	\$730	\$810	\$900	+ \$25	+ \$50
24"	EP(3/N)FA2429(K/N)	\$530	\$560	\$600	\$650	\$710	\$780	\$860	\$950	+ \$25	+ \$50
30"	EP(3/N)FA3029(K/N)	\$580	\$610	\$650	\$700	\$760	\$830	\$910	\$1,000	+ \$25	+ \$50
36"	EP(3/N)FA3629(K/N)	\$650	\$710	\$790	\$890	\$1,010	\$1,150	\$1,310	\$1,490	+ \$25	+ \$50
42"	EP(3/N)FA4229(K/N)	\$690	\$750	\$830	\$930	\$1,050	\$1,190	\$1,350	\$1,530	+ \$25	+ \$50
48"	EP(3/N)FA4829(K/N)	\$730	\$790	\$870	\$970	\$1,090	\$1,230	\$1,390	\$1,570	+ \$25	+ \$50
60"	EP(3/N)FA6029(K/N)	\$770	\$830	\$910	\$1,010	\$1,130	\$1,270	\$1,430	\$1,610	+ \$25	+ \$50

## 36" H

12"	EP(3/N)FA1236(K/N)	\$455	\$490	\$535	\$590	\$660	\$740	\$835	\$945	+ \$25	+ \$50
18"	EP(3/N)FA1836(K/N)	\$505	\$540	\$585	\$640	\$710	\$790	\$885	\$995	+ \$25	+ \$50
24"	EP(3/N)FA2436(K/N)	\$555	\$590	\$635	\$690	\$760	\$840	\$935	\$1,045	+ \$25	+ \$50
30"	EP(3/N)FA3036(K/N)	\$605	\$640	\$685	\$740	\$810	\$890	\$985	\$1,095	+ \$25	+ \$50
36"	EP(3/N)FA3636(K/N)	\$675	\$745	\$835	\$945	\$1,085	\$1,250	\$1,450	\$1,685	+ \$25	+ \$50
42"	EP(3/N)FA4236(K/N)	\$720	\$790	\$880	\$990	\$1,130	\$1,295	\$1,495	\$1,730	+ \$25	+ \$50
48"	EP(3/N)FA4836(K/N)	\$765	\$835	\$925	\$1,035	\$1,175	\$1,340	\$1,540	\$1,775	+ \$25	+ \$50
60"	EP(3/N)FA6036(K/N)	\$810	\$880	\$970	\$1,080	\$1,220	\$1,385	\$1,585	\$1,820	+ \$25	+ \$50

## 41" H

12"	EP(3/N)FA1241(K/N)	\$480	\$520	\$570	\$630	\$710	\$800	\$910	\$1,040	+ \$25	+ \$50
18"	EP(3/N)FA1841(K/N)	\$530	\$570	\$620	\$680	\$760	\$850	\$960	\$1,090	+ \$25	+ \$50
24"	EP(3/N)FA2441(K/N)	\$580	\$620	\$670	\$730	\$810	\$900	\$1,010	\$1,140	+ \$25	+ \$50
30"	EP(3/N)FA3041(K/N)	\$630	\$670	\$720	\$780	\$860	\$950	\$1,060	\$1,190	+ \$25	+ \$50
36"	EP(3/N)FA3641(K/N)	\$700	\$780	\$880	\$1,000	\$1,160	\$1,350	\$1,590	\$1,880	+ \$25	+ \$50
42"	EP(3/N)FA4241(K/N)	\$750	\$830	\$930	\$1,050	\$1,210	\$1,400	\$1,640	\$1,930	+ \$25	+ \$50
48"	EP(3/N)FA4841(K/N)	\$800	\$880	\$980	\$1,100	\$1,260	\$1,450	\$1,690	\$1,980	+ \$25	+ \$50
60"	EP(3/N)FA6041(K/N)	\$850	\$930	\$1,030	\$1,150	\$1,310	\$1,500	\$1,740	\$2,030	+ \$25	+ \$50

## 49" H

12"	EP(3/N)FA1249(K/N)	\$540	\$580	\$630	\$690	\$770	\$870	\$990	\$1,140	+ \$25	+ \$50
18"	EP(3/N)FA1849(K/N)	\$590	\$630	\$680	\$740	\$820	\$920	\$1,040	\$1,190	+ \$25	+ \$50
24"	EP(3/N)FA2449(K/N)	\$640	\$680	\$730	\$790	\$870	\$970	\$1,090	\$1,240	+ \$25	+ \$50
30"	EP(3/N)FA3049(K/N)	\$690	\$730	\$780	\$840	\$920	\$1,020	\$1,140	\$1,290	+ \$25	+ \$50
36"	EP(3/N)FA3649(K/N)	\$760	\$840	\$940	\$1,060	\$1,230	\$1,440	\$1,710	\$2,030	+ \$25	+ \$50
42"	EP(3/N)FA4249(K/N)	\$810	\$890	\$990	\$1,110	\$1,280	\$1,490	\$1,760	\$2,080	+ \$25	+ \$50
48"	EP(3/N)FA4849(K/N)	\$860	\$940	\$1,040	\$1,160	\$1,330	\$1,540	\$1,810	\$2,130	+ \$25	+ \$50
60"	EP(3/N)FA6049(K/N)	\$930	\$1,010	\$1,110	\$1,230	\$1,400	\$1,610	\$1,880	\$2,200	+ \$25	+ \$50

### Specify

1. Model #
2. Fabric
3. Paint

### Application Notes

The panel is fabric covered. If two different fabrics are used on one panel, the price will reflect the cost of the most expensive panel fabric.

**NOTE: Power duplexes cannot be installed on 12" W panels. Side mount receptacles available on 24" W panels and wider.**

### Assembly

- Included**
- Panel
  - Top cap
  - Metal raceway covers

### Ordered Separately

- Posts
- Panel connectors
- Electrical components

### Top Cap Styles

3 – Beveled

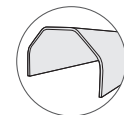

N – Flat

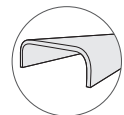



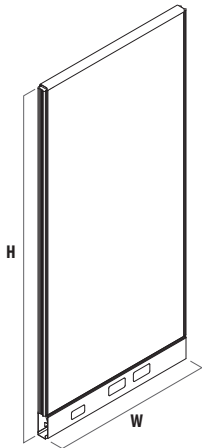

## 54" H

W	MODEL #	FABRIC								PAINT	
		A	B	C	D	E	F	G	H	P2	P3
12"	EP(3/N)FA1254(K/N)	\$590	\$630	\$680	\$750	\$850	\$960	\$1,090	\$1,250	+ \$25	+ \$50
18"	EP(3/N)FA1854(K/N)	\$640	\$680	\$730	\$800	\$900	\$1,010	\$1,140	\$1,300	+ \$25	+ \$50
24"	EP(3/N)FA2454(K/N)	\$690	\$730	\$780	\$850	\$950	\$1,060	\$1,190	\$1,350	+ \$25	+ \$50
30"	EP(3/N)FA3054(K/N)	\$740	\$780	\$830	\$900	\$1,000	\$1,110	\$1,240	\$1,400	+ \$25	+ \$50
36"	EP(3/N)FA3654(K/N)	\$820	\$910	\$1,010	\$1,150	\$1,360	\$1,590	\$1,860	\$2,190	+ \$25	+ \$50
42"	EP(3/N)FA4254(K/N)	\$870	\$960	\$1,060	\$1,200	\$1,410	\$1,640	\$1,910	\$2,240	+ \$25	+ \$50
48"	EP(3/N)FA4854(K/N)	\$920	\$1,010	\$1,110	\$1,250	\$1,460	\$1,690	\$1,960	\$2,290	+ \$25	+ \$50
60"	EP(3/N)FA6054(K/N)	\$990	\$1,080	\$1,180	\$1,320	\$1,530	\$1,760	\$2,030	\$2,360	+ \$25	+ \$50

## 61" H

12"	EP(3/N)FA1261(K/N)	\$640	\$690	\$750	\$830	\$940	\$1,060	\$1,200	\$1,370	+ \$25	+ \$50
18"	EP(3/N)FA1861(K/N)	\$690	\$740	\$800	\$880	\$990	\$1,110	\$1,250	\$1,420	+ \$25	+ \$50
24"	EP(3/N)FA2461(K/N)	\$740	\$790	\$850	\$930	\$1,040	\$1,160	\$1,300	\$1,470	+ \$25	+ \$50
30"	EP(3/N)FA3061(K/N)	\$790	\$840	\$900	\$980	\$1,090	\$1,210	\$1,350	\$1,520	+ \$25	+ \$50
36"	EP(3/N)FA3661(K/N)	\$860	\$960	\$1,080	\$1,240	\$1,470	\$1,720	\$2,000	\$2,340	+ \$25	+ \$50
42"	EP(3/N)FA4261(K/N)	\$910	\$1,010	\$1,130	\$1,290	\$1,520	\$1,770	\$2,050	\$2,390	+ \$25	+ \$50
48"	EP(3/N)FA4861(K/N)	\$960	\$1,060	\$1,180	\$1,340	\$1,570	\$1,820	\$2,100	\$2,440	+ \$25	+ \$50
60"	EP(3/N)FA6061(K/N)	\$1,050	\$1,150	\$1,270	\$1,430	\$1,660	\$1,910	\$2,190	\$2,530	+ \$25	+ \$50

## 66" H

12"	EP(3/N)FA1266(K/N)	\$660	\$710	\$770	\$850	\$970	\$1,100	\$1,250	\$1,430	+ \$25	+ \$50
18"	EP(3/N)FA1866(K/N)	\$710	\$760	\$820	\$900	\$1,020	\$1,150	\$1,300	\$1,480	+ \$25	+ \$50
24"	EP(3/N)FA2466(K/N)	\$760	\$810	\$870	\$950	\$1,070	\$1,200	\$1,350	\$1,530	+ \$25	+ \$50
30"	EP(3/N)FA3066(K/N)	\$810	\$860	\$920	\$1,000	\$1,120	\$1,250	\$1,400	\$1,580	+ \$25	+ \$50
36"	EP(3/N)FA3666(K/N)	\$890	\$1,000	\$1,130	\$1,290	\$1,540	\$1,820	\$2,140	\$2,530	+ \$25	+ \$50
42"	EP(3/N)FA4266(K/N)	\$940	\$1,050	\$1,180	\$1,340	\$1,590	\$1,870	\$2,190	\$2,580	+ \$25	+ \$50
48"	EP(3/N)FA4866(K/N)	\$990	\$1,100	\$1,230	\$1,390	\$1,640	\$1,920	\$2,240	\$2,630	+ \$25	+ \$50
60"	EP(3/N)FA6066(K/N)	\$1,080	\$1,190	\$1,320	\$1,480	\$1,730	\$2,010	\$2,330	\$2,720	+ \$25	+ \$50

## 81" H

12"	EP(3/N)FA1281(K/N)	\$710	\$770	\$830	\$920	\$1,070	\$1,240	\$1,430	\$1,650	+ \$25	+ \$50
18"	EP(3/N)FA1881(K/N)	\$760	\$820	\$880	\$970	\$1,120	\$1,290	\$1,480	\$1,700	+ \$25	+ \$50
24"	EP(3/N)FA2481(K/N)	\$810	\$870	\$930	\$1,020	\$1,170	\$1,340	\$1,530	\$1,750	+ \$25	+ \$50
30"	EP(3/N)FA3081(K/N)	\$860	\$920	\$980	\$1,070	\$1,220	\$1,390	\$1,580	\$1,800	+ \$25	+ \$50
36"	EP(3/N)FA3681(K/N)	\$1,040	\$1,160	\$1,280	\$1,470	\$1,800	\$2,170	\$2,580	\$3,040	+ \$25	+ \$50
42"	EP(3/N)FA4281(K/N)	\$1,160	\$1,280	\$1,400	\$1,590	\$1,920	\$2,290	\$2,700	\$3,160	+ \$25	+ \$50
48"	EP(3/N)FA4881(K/N)	\$1,250	\$1,370	\$1,490	\$1,680	\$2,010	\$2,380	\$2,790	\$3,250	+ \$25	+ \$50
60"	EP(3/N)FA6081(K/N)	\$1,340	\$1,460	\$1,580	\$1,770	\$2,100	\$2,470	\$2,880	\$3,340	+ \$25	+ \$50

### Guardian® Panel Option

BULLET RESISTANT PANEL

- NIJ Level IIIA compliant
- Protection against handguns up to .44 Magnum
- Inconspicuous – looks like a regular panel

#### UPCHARGE (NET)

WIDTH	HEIGHT						
	29"	41"	49"	54"	61"	66"	81"
30"	\$218	\$315	\$368	\$405	\$458	\$495	\$607
36"	\$261	\$378	\$441	\$486	\$549	\$594	\$729
42"	\$305	\$441	\$515	\$567	\$641	\$693	\$850
48"	\$348	\$504	\$588	\$648	\$732	\$792	\$972

**NOTE:** To specify a Guardian Panel add a "G" to the end of the panels model number.

Pricing is for P1 paint colors. Add the appropriate upcharge if using P2 or P3 trim.

# Insert Panels

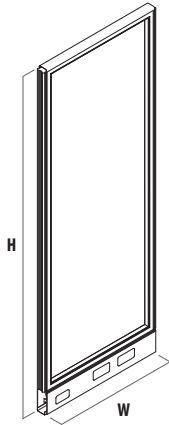

## 29" H

W	MODEL #	OF	GLASS INSERT			LAMINATE INSERT			PAINT	
			DG	GL	PG	L1	L2	L3	P2	P3
12"	EP(3/N)( )1229(K/N)	\$697	\$1,097	\$937	\$847	\$897	\$987	\$1,076	+ \$25	+ \$50
18"	EP(3/N)( )1829(K/N)	\$707	\$1,197	\$967	\$867	\$947	\$1,042	\$1,136	+ \$25	+ \$50
24"	EP(3/N)( )2429(K/N)	\$717	\$1,297	\$997	\$887	\$977	\$1,075	\$1,172	+ \$25	+ \$50
30"	EP(3/N)( )3029(K/N)	\$737	\$1,397	\$1,037	\$917	\$1,007	\$1,108	\$1,208	+ \$25	+ \$50
36"	EP(3/N)( )3629(K/N)	\$757	\$1,487	\$1,087	\$957	\$1,057	\$1,163	\$1,268	+ \$25	+ \$50
42"	EP(3/N)( )4229(K/N)	\$777	\$1,587	\$1,137	\$1,007	\$1,107	\$1,218	\$1,328	+ \$25	+ \$50
48"	EP(3/N)( )4829(K/N)	\$797	\$1,697	\$1,197	\$1,067	\$1,167	\$1,284	\$1,400	+ \$25	+ \$50
60"	EP(3/N)( )6029(K/N)	\$837	\$1,867	\$1,267	\$1,137	\$1,237	\$1,361	\$1,484	+ \$25	+ \$50

## 41" H

12"	EP(3/N)( )1241(K/N)	\$737	\$1,237	\$1,057	\$947	\$947	\$1,042	\$1,136	+ \$25	+ \$50
18"	EP(3/N)( )1841(K/N)	\$747	\$1,327	\$1,077	\$967	\$1,047	\$1,152	\$1,256	+ \$25	+ \$50
24"	EP(3/N)( )2441(K/N)	\$757	\$1,437	\$1,117	\$997	\$1,087	\$1,196	\$1,304	+ \$25	+ \$50
30"	EP(3/N)( )3041(K/N)	\$777	\$1,567	\$1,167	\$1,037	\$1,137	\$1,251	\$1,364	+ \$25	+ \$50
36"	EP(3/N)( )3641(K/N)	\$797	\$1,667	\$1,217	\$1,087	\$1,187	\$1,306	\$1,424	+ \$25	+ \$50
42"	EP(3/N)( )4241(K/N)	\$817	\$1,777	\$1,277	\$1,147	\$1,247	\$1,372	\$1,496	+ \$25	+ \$50
48"	EP(3/N)( )4841(K/N)	\$837	\$1,957	\$1,357	\$1,217	\$1,327	\$1,460	\$1,592	+ \$25	+ \$50
60"	EP(3/N)( )6041(K/N)	\$877	\$2,247	\$1,447	\$1,297	\$1,417	\$1,559	\$1,700	+ \$25	+ \$50

## 49" H

12"	EP(3/N)( )1249(K/N)	\$747	\$1,257	\$1,077	\$967	\$997	\$1,097	\$1,196	+ \$25	+ \$50
18"	EP(3/N)( )1849(K/N)	\$757	\$1,357	\$1,107	\$997	\$1,077	\$1,185	\$1,292	+ \$25	+ \$50
24"	EP(3/N)( )2449(K/N)	\$767	\$1,477	\$1,157	\$1,037	\$1,127	\$1,240	\$1,352	+ \$25	+ \$50
30"	EP(3/N)( )3049(K/N)	\$787	\$1,637	\$1,217	\$1,087	\$1,187	\$1,306	\$1,424	+ \$25	+ \$50
36"	EP(3/N)( )3649(K/N)	\$807	\$1,797	\$1,277	\$1,147	\$1,247	\$1,372	\$1,496	+ \$25	+ \$50
42"	EP(3/N)( )4249(K/N)	\$827	\$1,967	\$1,347	\$1,217	\$1,317	\$1,449	\$1,580	+ \$25	+ \$50
48"	EP(3/N)( )4849(K/N)	\$847	\$2,147	\$1,427	\$1,297	\$1,397	\$1,537	\$1,676	+ \$25	+ \$50
60"	EP(3/N)( )6049(K/N)	\$887	\$2,377	\$1,557	\$1,407	\$1,527	\$1,680	\$1,832	+ \$25	+ \$50

### Specify

1. Model #
2. Insert type
3. Insert color
4. Paint

**NOTE: Power duplexes cannot be installed on 12" W panels. Side mount receptacles available on 24" W panels and wider.**

### Plexiglass Finishes

**CL** . . Clear  
**IC** . . Ice  
**SM** . . Smoked  
**TR** . . Translucent

### Glass Finishes

**CL** . . Clear  
**GR** . . Grey  
**SM** . . Smoked  
**TR** . . Translucent

### Application Notes

Insert Panels are constructed with a tapered aluminum frame that is mitered in the corners. Insert panels may be ordered with multiple insert options, or as an open frame for complete accessibility through the panel.

### Assembly

**Included**

- Panel
- Top cap
- Metal raceway covers

### Ordered Separately

- Posts
- Panel connectors
- Electrical components

### Top Cap Styles

3 – Beveled

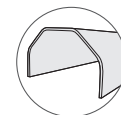

N – Flat

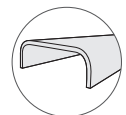

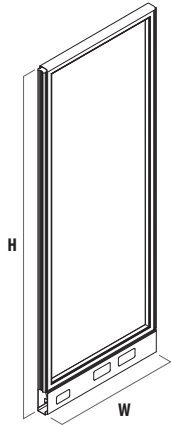

## 54" H

W	MODEL #	OF	GLASS INSERT			LAMINATE INSERT			PAINT	
			DG	GL	PG	L1	L2	L3	P2	P3
12"	EP(3/N)( )1254(K/N)	\$777	\$1,267	\$1,087	\$977	\$1,047	\$1,152	\$1,256	+ \$25	+ \$50
18"	EP(3/N)( )1854(K/N)	\$787	\$1,377	\$1,127	\$1,017	\$1,097	\$1,207	\$1,316	+ \$25	+ \$50
24"	EP(3/N)( )2454(K/N)	\$797	\$1,507	\$1,187	\$1,067	\$1,157	\$1,273	\$1,388	+ \$25	+ \$50
30"	EP(3/N)( )3054(K/N)	\$817	\$1,677	\$1,257	\$1,127	\$1,227	\$1,350	\$1,472	+ \$25	+ \$50
36"	EP(3/N)( )3654(K/N)	\$837	\$1,847	\$1,327	\$1,197	\$1,297	\$1,427	\$1,556	+ \$25	+ \$50
42"	EP(3/N)( )4254(K/N)	\$857	\$2,027	\$1,407	\$1,277	\$1,377	\$1,515	\$1,652	+ \$25	+ \$50
48"	EP(3/N)( )4854(K/N)	\$877	\$2,227	\$1,507	\$1,367	\$1,477	\$1,625	\$1,772	+ \$25	+ \$50
60"	EP(3/N)( )6054(K/N)	\$917	\$2,447	\$1,627	\$1,477	\$1,597	\$1,757	\$1,916	+ \$25	+ \$50

## 61" H

12"	EP(3/N)( )1261(K/N)	\$787	\$1,307	\$1,107	\$987	\$1,067	\$1,174	\$1,280	+ \$25	+ \$50
18"	EP(3/N)( )1861(K/N)	\$797	\$1,407	\$1,157	\$1,037	\$1,117	\$1,229	\$1,340	+ \$25	+ \$50
24"	EP(3/N)( )2461(K/N)	\$807	\$1,557	\$1,227	\$1,097	\$1,187	\$1,306	\$1,424	+ \$25	+ \$50
30"	EP(3/N)( )3061(K/N)	\$827	\$1,737	\$1,307	\$1,167	\$1,267	\$1,394	\$1,520	+ \$25	+ \$50
36"	EP(3/N)( )3661(K/N)	\$847	\$1,917	\$1,387	\$1,247	\$1,347	\$1,482	\$1,616	+ \$25	+ \$50
42"	EP(3/N)( )4261(K/N)	\$867	\$2,117	\$1,487	\$1,337	\$1,447	\$1,592	\$1,736	+ \$25	+ \$50
48"	EP(3/N)( )4861(K/N)	\$887	\$2,327	\$1,597	\$1,437	\$1,557	\$1,713	\$1,868	+ \$25	+ \$50
60"	EP(3/N)( )6061(K/N)	\$937	\$2,657	\$1,717	\$1,547	\$1,677	\$1,845	\$2,012	+ \$25	+ \$50

## 66" H

12"	EP(3/N)( )1266(K/N)	\$797	\$1,317	\$1,117	\$997	\$1,077	\$1,185	\$1,292	+ \$25	+ \$50
18"	EP(3/N)( )1866(K/N)	\$807	\$1,447	\$1,177	\$1,057	\$1,137	\$1,251	\$1,364	+ \$25	+ \$50
24"	EP(3/N)( )2466(K/N)	\$817	\$1,607	\$1,257	\$1,127	\$1,217	\$1,339	\$1,460	+ \$25	+ \$50
30"	EP(3/N)( )3066(K/N)	\$837	\$1,797	\$1,347	\$1,207	\$1,307	\$1,438	\$1,568	+ \$25	+ \$50
36"	EP(3/N)( )3666(K/N)	\$857	\$1,987	\$1,437	\$1,297	\$1,397	\$1,537	\$1,676	+ \$25	+ \$50
42"	EP(3/N)( )4266(K/N)	\$877	\$2,197	\$1,547	\$1,397	\$1,507	\$1,658	\$1,808	+ \$25	+ \$50
48"	EP(3/N)( )4866(K/N)	\$897	\$2,417	\$1,667	\$1,507	\$1,627	\$1,790	\$1,952	+ \$25	+ \$50
60"	EP(3/N)( )6066(K/N)	\$947	\$2,737	\$1,787	\$1,627	\$1,747	\$1,922	\$2,096	+ \$25	+ \$50

## 81" H

12"	EP(3/N)( )1281(K/N)	\$857	\$1,547	\$1,327	\$1,187	\$1,287	\$1,416	\$1,544	+ \$25	+ \$50
18"	EP(3/N)( )1881(K/N)	\$867	\$1,727	\$1,427	\$1,287	\$1,387	\$1,526	\$1,664	+ \$25	+ \$50
24"	EP(3/N)( )2481(K/N)	\$877	\$1,927	\$1,527	\$1,387	\$1,487	\$1,636	\$1,784	+ \$25	+ \$50
30"	EP(3/N)( )3081(K/N)	\$897	\$2,127	\$1,627	\$1,487	\$1,587	\$1,746	\$1,904	+ \$25	+ \$50
36"	EP(3/N)( )3681(K/N)	\$917	\$2,327	\$1,727	\$1,587	\$1,687	\$1,856	\$2,024	+ \$25	+ \$50
42"	EP(3/N)( )4281(K/N)	\$937	\$2,527	\$1,827	\$1,687	\$1,787	\$1,966	\$2,144	+ \$25	+ \$50
48"	EP(3/N)( )4881(K/N)	\$957	\$2,747	\$1,947	\$1,807	\$1,907	\$2,098	\$2,288	+ \$25	+ \$50
60"	EP(3/N)( )6081(K/N)	\$1,027	\$3,347	\$2,097	\$1,957	\$2,057	\$2,263	\$2,468	+ \$25	+ \$50

		Top Cap	Panel Type		W	H	Raceway	
EP	Equity panel	3 Beveled N Flat	OF Open frame DG Designer glass insert GL Glass insert PG Plexiglass insert LM Laminate insert		36	29	K With knockouts N Without knockouts	
EP		N	PG		36	29	K	

# Insert Panels

## Perforated Aluminum

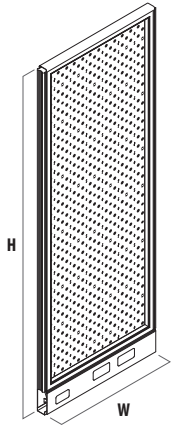

### 29" H

W	MODEL #	PA	INSERT PAINT			PAINT	
			P1	P2	P3	P2	P3
12"	EP(3/N)PA1229(K/N)	\$797	\$847	\$857	\$867	+ \$25	+ \$50
18"	EP(3/N)PA1829(K/N)	\$807	\$867	\$887	\$907	+ \$25	+ \$50
24"	EP(3/N)PA2429(K/N)	\$827	\$887	\$917	\$947	+ \$25	+ \$50
30"	EP(3/N)PA3029(K/N)	\$857	\$917	\$947	\$987	+ \$25	+ \$50
36"	EP(3/N)PA3629(K/N)	\$897	\$957	\$987	\$1,027	+ \$25	+ \$50
42"	EP(3/N)PA4229(K/N)	\$937	\$1,007	\$1,047	\$1,087	+ \$25	+ \$50
48"	EP(3/N)PA4829(K/N)	\$997	\$1,067	\$1,117	\$1,167	+ \$25	+ \$50
60"	EP(3/N)PA6029(K/N)	\$1,067	\$1,137	\$1,197	\$1,257	+ \$25	+ \$50

### 41" H

12"	EP(3/N)PA1241(K/N)	\$877	\$947	\$967	\$987	+ \$25	+ \$50
18"	EP(3/N)PA1841(K/N)	\$897	\$967	\$987	\$1,017	+ \$25	+ \$50
24"	EP(3/N)PA2441(K/N)	\$927	\$997	\$1,027	\$1,067	+ \$25	+ \$50
30"	EP(3/N)PA3041(K/N)	\$967	\$1,037	\$1,077	\$1,127	+ \$25	+ \$50
36"	EP(3/N)PA3641(K/N)	\$1,017	\$1,087	\$1,137	\$1,197	+ \$25	+ \$50
42"	EP(3/N)PA4241(K/N)	\$1,067	\$1,147	\$1,207	\$1,277	+ \$25	+ \$50
48"	EP(3/N)PA4841(K/N)	\$1,137	\$1,217	\$1,297	\$1,367	+ \$25	+ \$50
60"	EP(3/N)PA6041(K/N)	\$1,217	\$1,297	\$1,397	\$1,487	+ \$25	+ \$50

### 49" H

12"	EP(3/N)PA1249(K/N)	\$897	\$967	\$987	\$1,007	+ \$25	+ \$50
18"	EP(3/N)PA1849(K/N)	\$927	\$997	\$1,027	\$1,057	+ \$25	+ \$50
24"	EP(3/N)PA2449(K/N)	\$967	\$1,037	\$1,087	\$1,127	+ \$25	+ \$50
30"	EP(3/N)PA3049(K/N)	\$1,017	\$1,087	\$1,147	\$1,197	+ \$25	+ \$50
36"	EP(3/N)PA3649(K/N)	\$1,067	\$1,147	\$1,217	\$1,287	+ \$25	+ \$50
42"	EP(3/N)PA4249(K/N)	\$1,137	\$1,217	\$1,297	\$1,387	+ \$25	+ \$50
48"	EP(3/N)PA4849(K/N)	\$1,217	\$1,297	\$1,397	\$1,497	+ \$25	+ \$50
60"	EP(3/N)PA6049(K/N)	\$1,327	\$1,407	\$1,527	\$1,637	+ \$25	+ \$50

#### Specify

1. Model #
2. Insert paint
3. Paint

**NOTE: Power duplexes cannot be installed on 12" W panels. Side mount receptacles available on 24" W panels and wider.**

#### Application Notes

Insert Panels are constructed with a tapered aluminum frame that is mitered in the corners. Insert panels may be ordered multiple insert options, or as an open frame for complete accessibility through the panel.

#### Assembly

- Included**
- Panel
  - Top cap
  - Metal raceway covers

#### Ordered Separately

- Posts
- Panel connectors
- Electrical components

#### Top Cap Styles

3 – Beveled

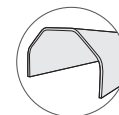

N – Flat

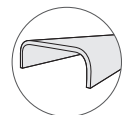

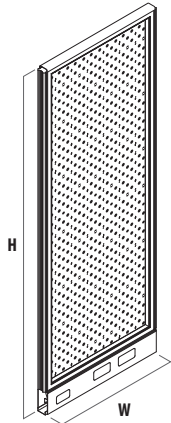

## 54" H

W	MODEL #	PA	INSERT PAINT			PAINT	
			P1	P2	P3	P2	P3
12"	EP(3/N)PA1254(K/N)	\$907	\$977	\$997	\$1,017	+ \$25	+ \$50
18"	EP(3/N)PA1854(K/N)	\$947	\$1,017	\$1,047	\$1,077	+ \$25	+ \$50
24"	EP(3/N)PA2454(K/N)	\$997	\$1,067	\$1,117	\$1,167	+ \$25	+ \$50
30"	EP(3/N)PA3054(K/N)	\$1,047	\$1,127	\$1,187	\$1,247	+ \$25	+ \$50
36"	EP(3/N)PA3654(K/N)	\$1,117	\$1,197	\$1,277	\$1,357	+ \$25	+ \$50
42"	EP(3/N)PA4254(K/N)	\$1,197	\$1,277	\$1,367	\$1,457	+ \$25	+ \$50
48"	EP(3/N)PA4854(K/N)	\$1,287	\$1,367	\$1,467	\$1,567	+ \$25	+ \$50
60"	EP(3/N)PA6054(K/N)	\$1,397	\$1,477	\$1,607	\$1,737	+ \$25	+ \$50

## 61" H

12"	EP(3/N)PA1261(K/N)	\$917	\$987	\$1,007	\$1,037	+ \$25	+ \$50
18"	EP(3/N)PA1861(K/N)	\$967	\$1,037	\$1,077	\$1,117	+ \$25	+ \$50
24"	EP(3/N)PA2461(K/N)	\$1,017	\$1,097	\$1,147	\$1,197	+ \$25	+ \$50
30"	EP(3/N)PA3061(K/N)	\$1,087	\$1,167	\$1,227	\$1,297	+ \$25	+ \$50
36"	EP(3/N)PA3661(K/N)	\$1,167	\$1,247	\$1,327	\$1,407	+ \$25	+ \$50
42"	EP(3/N)PA4261(K/N)	\$1,257	\$1,337	\$1,427	\$1,527	+ \$25	+ \$50
48"	EP(3/N)PA4861(K/N)	\$1,357	\$1,437	\$1,537	\$1,657	+ \$25	+ \$50
60"	EP(3/N)PA6061(K/N)	\$1,687	\$1,747	\$1,867	\$2,007	+ \$25	+ \$50

## 66" H

12"	EP(3/N)PA1266(K/N)	\$927	\$997	\$1,027	\$1,057	+ \$25	+ \$50
18"	EP(3/N)PA1866(K/N)	\$987	\$1,057	\$1,097	\$1,147	+ \$25	+ \$50
24"	EP(3/N)PA2466(K/N)	\$1,047	\$1,127	\$1,177	\$1,237	+ \$25	+ \$50
30"	EP(3/N)PA3066(K/N)	\$1,127	\$1,207	\$1,277	\$1,347	+ \$25	+ \$50
36"	EP(3/N)PA3666(K/N)	\$1,217	\$1,297	\$1,387	\$1,477	+ \$25	+ \$50
42"	EP(3/N)PA4266(K/N)	\$1,307	\$1,397	\$1,497	\$1,597	+ \$25	+ \$50
48"	EP(3/N)PA4866(K/N)	\$1,397	\$1,507	\$1,627	\$1,747	+ \$25	+ \$50
60"	EP(3/N)PA6066(K/N)	\$1,707	\$1,877	\$2,007	\$2,157	+ \$25	+ \$50

## 81" H

12"	EP(3/N)PA1281(K/N)	\$1,087	\$1,187	\$1,227	\$1,277	+ \$25	+ \$50
18"	EP(3/N)PA1881(K/N)	\$1,187	\$1,287	\$1,347	\$1,427	+ \$25	+ \$50
24"	EP(3/N)PA2481(K/N)	\$1,287	\$1,387	\$1,467	\$1,567	+ \$25	+ \$50
30"	EP(3/N)PA3081(K/N)	\$1,487	\$1,587	\$1,687	\$1,807	+ \$25	+ \$50
36"	EP(3/N)PA3681(K/N)	\$1,587	\$1,687	\$1,807	\$1,947	+ \$25	+ \$50
42"	EP(3/N)PA4281(K/N)	\$1,647	\$1,747	\$1,907	\$2,057	+ \$25	+ \$50
48"	EP(3/N)PA4881(K/N)	\$1,697	\$1,797	\$2,007	\$2,167	+ \$25	+ \$50
60"	EP(3/N)PA6081(K/N)	\$2,197	\$2,397	\$2,647	\$2,847	+ \$25	+ \$50

		Top Cap	Panel Type	W	H	Raceway	
EP	Equity panel	3 Beveled N Flat	PA Perforated Aluminum	36	29	K With knockouts N Without knockouts	
EP		N	PA	36	29	K	

## Tequity™ Panels

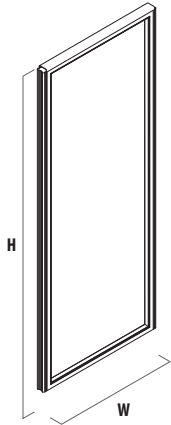

## 29" H

W	MODEL #	PAINT		
		P1	P2	P3
12"	EP(3/N)TQ1229	\$330	\$380	\$405
18"	EP(3/N)TQ1829	\$380	\$430	\$455
24"	EP(3/N)TQ2429	\$430	\$480	\$505
30"	EP(3/N)TQ3029	\$480	\$530	\$555
36"	EP(3/N)TQ3629	\$550	\$600	\$625
42"	EP(3/N)TQ4229	\$590	\$640	\$665
48"	EP(3/N)TQ4829	\$630	\$680	\$705
60"	EP(3/N)TQ6029	\$670	\$720	\$745

## 41" H

12"	EP(3/N)TQ1241	\$380	\$430	\$455
18"	EP(3/N)TQ1841	\$430	\$480	\$505
24"	EP(3/N)TQ2441	\$480	\$530	\$555
30"	EP(3/N)TQ3041	\$530	\$580	\$605
36"	EP(3/N)TQ3641	\$600	\$650	\$675
42"	EP(3/N)TQ4241	\$650	\$700	\$725
48"	EP(3/N)TQ4841	\$700	\$750	\$775
60"	EP(3/N)TQ6041	\$750	\$800	\$825

## 49" H

12"	EP(3/N)TQ1249	\$440	\$490	\$515
18"	EP(3/N)TQ1849	\$490	\$540	\$565
24"	EP(3/N)TQ2449	\$540	\$590	\$615
30"	EP(3/N)TQ3049	\$590	\$640	\$665
36"	EP(3/N)TQ3649	\$660	\$710	\$735
42"	EP(3/N)TQ4249	\$710	\$760	\$785
48"	EP(3/N)TQ4849	\$760	\$810	\$835
60"	EP(3/N)TQ6049	\$830	\$880	\$905

## Specify

1. Model #
2. Paint

## Application Notes

Tequity panels are constructed with a 16 gauge welded steel frame.

## Worksurface Support w/Tequity Panels

When specifying worksurfaces use panel to worksurface brackets to support each corner.

## Assembly

**Included**

- Panel
- Top cap

## Ordered Separately

- Posts
- Panel connectors

## Top Cap Styles

3 – Beveled

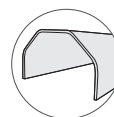

N – Flat



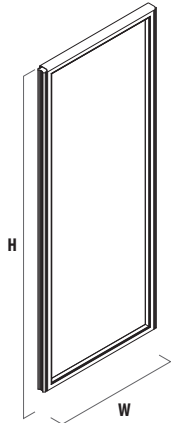

## 54" H

W	MODEL #	PAINT		
		P1	P2	P3
12"	EP(3/N)TQ1254	\$490	\$540	\$565
18"	EP(3/N)TQ1854	\$540	\$590	\$615
24"	EP(3/N)TQ2454	\$590	\$640	\$665
30"	EP(3/N)TQ3054	\$640	\$690	\$715
36"	EP(3/N)TQ3654	\$720	\$770	\$795
42"	EP(3/N)TQ4254	\$770	\$820	\$845
48"	EP(3/N)TQ4854	\$820	\$870	\$895
60"	EP(3/N)TQ6054	\$890	\$940	\$965

## 61" H

12"	EP(3/N)TQ1261	\$540	\$590	\$615
18"	EP(3/N)TQ1861	\$590	\$640	\$665
24"	EP(3/N)TQ2461	\$640	\$690	\$715
30"	EP(3/N)TQ3061	\$690	\$740	\$765
36"	EP(3/N)TQ3661	\$760	\$810	\$835
42"	EP(3/N)TQ4261	\$810	\$860	\$885
48"	EP(3/N)TQ4861	\$860	\$910	\$935
60"	EP(3/N)TQ6061	\$950	\$1,000	\$1,025

## 66" H

12"	EP(3/N)TQ1266	\$560	\$610	\$635
18"	EP(3/N)TQ1866	\$610	\$660	\$685
24"	EP(3/N)TQ2466	\$660	\$710	\$735
30"	EP(3/N)TQ3066	\$710	\$760	\$785
36"	EP(3/N)TQ3666	\$790	\$840	\$865
42"	EP(3/N)TQ4266	\$840	\$890	\$915
48"	EP(3/N)TQ4866	\$890	\$940	\$965
60"	EP(3/N)TQ6066	\$980	\$1,030	\$1,055

## 81" H

12"	EP(3/N)TQ1281	\$560	\$610	\$635
18"	EP(3/N)TQ1881	\$610	\$660	\$685
24"	EP(3/N)TQ2481	\$660	\$710	\$735
30"	EP(3/N)TQ3081	\$710	\$760	\$785
36"	EP(3/N)TQ3681	\$790	\$840	\$865
42"	EP(3/N)TQ4281	\$840	\$890	\$915
48"	EP(3/N)TQ4881	\$890	\$940	\$965
60"	EP(3/N)TQ6081	\$980	\$1,030	\$1,055

		Top Cap	Panel Type	W	H
EP	Equity panel	3 Beveled N Flat	TQ Tequity	36	29
EP		N	TQ	36	29



# Sliding Doors

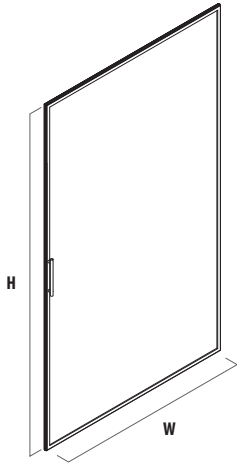

49" H			INSERT TYPE		LAMINATE INSERT			PAINT	
OPENING	ACTUAL OPENING	MODEL #	CR	PG	LM 1	LM 2	LM 3	P2	P3
36"	34.5"	EDR( )3649(L/R)B	\$2,207	\$1,577	\$1,507	\$1,658	\$1,808	+ \$25	+ \$50

54" H			INSERT TYPE		LAMINATE INSERT			PAINT	
OPENING	ACTUAL OPENING	MODEL #	CR	PG	LM 1	LM 2	LM 3	P2	P3
36"	34.5"	EDR( )3654(L/R)B	\$2,407	\$1,657	\$1,677	\$1,845	\$2,012	+ \$25	+ \$50

61" H			INSERT TYPE		LAMINATE INSERT			PAINT	
OPENING	ACTUAL OPENING	MODEL #	CR	PG	LM 1	LM 2	LM 3	P2	P3
36"	34.5"	EDR( )3661(L/R)B	\$2,707	\$1,727	\$1,757	\$1,933	\$2,108	+ \$25	+ \$50

Specify	Application Notes	Insert Type	Plexiglass Finishes	Corian Finishes
<ol style="list-style-type: none"> <li>1. Model #</li> <li>2. Insert type</li> <li>3. Insert color</li> <li>4. Paint</li> </ol>	<p>Sliding doors can mount on an end or corner post and require a straight, unobstructed panel run of at least 42" for their open position. Left/Right refers to opening direction.</p>	<p><b>CR</b> . Corian  <b>PG</b> . Plexiglass  <b>LM</b> . Laminate</p>	<p><b>CL</b> . Clear  <b>IC</b> . Ice  <b>SM</b> . Smoked  <b>TR</b> . Translucent  <b>LF</b> . Frost</p>	<p>Glacier White . . . . . <b>CR001</b>                      Pearl Grey . . . . . <b>CR002</b>                      Corian Clay . . . . . <b>CR003</b>                      Silver Grey . . . . . <b>CR004</b>                      Corian Grey . . . . . <b>CR001</b></p>
				Assembly
				<p><b>Included</b></p> <ul style="list-style-type: none"> <li>• Door</li> <li>• Hardware</li> </ul>

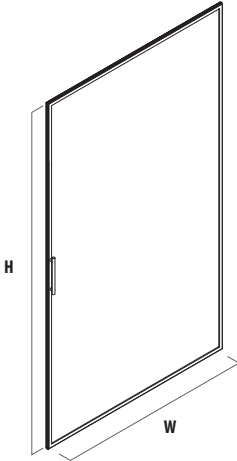

**66" H**

OPENING	ACTUAL OPENING	MODEL #	INSERT TYPE		LAMINATE INSERT			PAINT	
			CR	PG	LM 1	LM 2	LM 3	P2	P3
36"	34.5"	EDR( )3666(L/R)B	\$2,907	\$1,827	\$1,877	\$2,065	\$2,252	+\$25	+\$50

**81" H** — includes a header across the opening

36"	34.5"	EDR( )3681(L/R)B	\$3,307	\$1,877	\$2,157	\$2,373	\$2,588	+\$25	+\$50
-----	-------	------------------	---------	---------	---------	---------	---------	-------	-------

							For 81" Wide Only
Insert Type		W	H	Door Open	Door Handle	Anchor Panel Width	
EDR Equity door	CR Corian	36	61	L R	B Bar	42	
	PG Plexiglass					48	
	LM Laminate					60	
EDR	LM	36	61	L	B	42	

Pricing is for P1 paint colors. Add the appropriate upcharge if using P2 or P3 trim.

# Post Assemblies

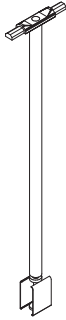

## Straight

H	MODEL #	PAINT		
		P1	P2	P3
29"	EP(3/N)P29S	\$148	\$155	\$162
36"	EP(3/N)P36S	\$149	\$156	\$163
41"	EP(3/N)P41S	\$150	\$157	\$164
49"	EP(3/N)P49S	\$152	\$159	\$166
54"	EP(3/N)P54S	\$154	\$161	\$168
61"	EP(3/N)P61S	\$156	\$163	\$170
66"	EP(3/N)P66S	\$158	\$165	\$172
81"	EP(3/N)P81S	\$175	\$182	\$189

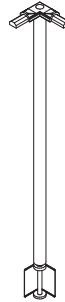

## 2-way L

H	MODEL #	PAINT		
		P1	P2	P3
29"	EP(3/N)P29L	\$148	\$155	\$162
36"	EP(3/N)P36L	\$149	\$156	\$163
41"	EP(3/N)P41L	\$150	\$157	\$164
49"	EP(3/N)P49L	\$153	\$160	\$167
54"	EP(3/N)P54L	\$157	\$164	\$171
61"	EP(3/N)P61L	\$165	\$172	\$179
66"	EP(3/N)P66L	\$172	\$179	\$186
81"	EP(3/N)P81L	\$185	\$192	\$199



## 2-way 120

29"	EP(3/N)P29120	\$159	\$166	\$173
36"	EP(3/N)P36120	\$163	\$170	\$177
41"	EP(3/N)P41120	\$167	\$174	\$181
49"	EP(3/N)P49120	\$171	\$178	\$185
54"	EP(3/N)P54120	\$175	\$182	\$189
61"	EP(3/N)P61120	\$183	\$190	\$197
66"	EP(3/N)P66120	\$190	\$197	\$204
81"	EP(3/N)P81120	\$202	\$209	\$216

### Specify

1. Model #
2. Paint

### Application Notes

Used to connect panels of the same height.

Bottom glides on post allow for up to 1 1/2" of vertical adjustment.

Add "NS" to the end of the model number to specify without shroud for use with Tequity panels.

### Assembly

#### Included

- Single height post
- Panel connector
- Appropriate metal shroud

### Top Cap Styles

3 – Beveled

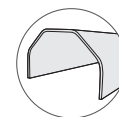

N – Flat

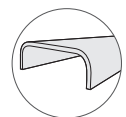

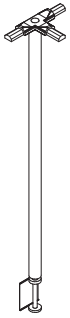

### 3-way T

H	MODEL #	PAINT		
		P1	P2	P3
29"	EP(3/N)P29T	\$148	\$155	\$162
36"	EP(3/N)P36T	\$149	\$156	\$163
41"	EP(3/N)P41T	\$150	\$157	\$164
49"	EP(3/N)P49T	\$152	\$159	\$166
54"	EP(3/N)P54T	\$154	\$161	\$168
61"	EP(3/N)P61T	\$157	\$164	\$171
66"	EP(3/N)P66T	\$164	\$171	\$178
81"	EP(3/N)P81T	\$176	\$183	\$190

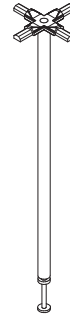

### 4-way X

H	MODEL #	PAINT		
		P1	P2	P3
29"	EP(3/N)P29X	\$148	\$155	\$162
36"	EP(3/N)P36X	\$149	\$156	\$163
41"	EP(3/N)P41X	\$150	\$157	\$164
49"	EP(3/N)P49X	\$152	\$159	\$166
54"	EP(3/N)P54X	\$154	\$161	\$168
61"	EP(3/N)P61X	\$156	\$163	\$170
66"	EP(3/N)P66X	\$158	\$165	\$172
81"	EP(3/N)P81X	\$171	\$178	\$185



### 3-way 120

29"	EP(3/N)P29Y	\$179	\$188	\$197
36"	EP(3/N)P36Y	\$180	\$189	\$198
41"	EP(3/N)P41Y	\$181	\$190	\$199
49"	EP(3/N)P49Y	\$183	\$192	\$201
54"	EP(3/N)P54Y	\$185	\$194	\$203
61"	EP(3/N)P61Y	\$187	\$196	\$205
66"	EP(3/N)P66Y	\$193	\$202	\$211
81"	EP(3/N)P81Y	\$206	\$215	\$224



### Carpet Gripper

DESCRIPTION	MODEL #	BLACK ONLY
12 Pack	EP1CG12	\$38

Top Cap							H		Connection Type		Options			
Equity panel		3 Beveled	N Flat	P Post	29	120	2-way 120	E End w/post	L 2-way L	T 3-way T	S <b>Straight</b>	X 4-way	Y 3-way 120	NS No Shroud
EP				P	29	S								

# End Kits



## End w/Post

H	MODEL #	PAINT		
		P1	P2	P3
29"	EP(3/N)P29E	\$159	\$166	\$173
36"	EP(3/N)P36E	\$162	\$169	\$176
41"	EP(3/N)P41E	\$164	\$171	\$178
49"	EP(3/N)P49E	\$168	\$175	\$182
54"	EP(3/N)P54E	\$171	\$178	\$185
61"	EP(3/N)P61E	\$180	\$187	\$194
66"	EP(3/N)P66E	\$186	\$193	\$200
81"	EP(3/N)P81E	\$199	\$206	\$213

## End w/Post

### Specify

1. Model #
2. Paint

### Application Notes

Used to finish a panel end that is not being connected to another panel.

Add "NS" to the end of the model number to specify without shroud for use with Tequity panels.

### Assembly

#### Included

- Single height post
- Panel connector
- Appropriate metal shroud

### Top Cap Styles

3 – Beveled

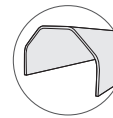

N – Flat

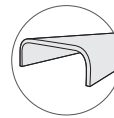



## Panel Wall Starter

W	D	H	H (Actual)	MODEL #	PAINT		
					P1	P2	P3
1 1/2"	1/2"	29"	23"	EP3PWS29	\$44	\$45	\$47
1 1/2"	1/2"	36"	30"	EP3PWS36	\$44	\$45	\$47
1 1/2"	1/2"	41"	35"	EP3PWS41	\$44	\$45	\$47
1 1/2"	1/2"	49"	43"	EP3PWS49	\$48	\$50	\$55
1 1/2"	1/2"	54"	49"	EP3PWS54	\$50	\$55	\$59
1 1/2"	1/2"	61"	55"	EP3PWS61	\$50	\$55	\$59
1 1/2"	1/2"	64"	60"	EP3PWS64	\$52	\$56	\$62
1 1/2"	1/2"	81"	75"	EP3PWS81	\$59	\$63	\$69



## Wall Mounted Channel

2 7/8"	3/4"	29"	23"	EP3WMC29	\$112	\$116	\$122
2 7/8"	3/4"	36"	30"	EP3WMC36	\$112	\$116	\$122
2 7/8"	3/4"	41"	35"	EP3WMC41	\$112	\$116	\$122
2 7/8"	3/4"	49"	43"	EP3WMC49	\$114	\$120	\$128
2 7/8"	3/4"	54"	49"	EP3WMC54	\$116	\$122	\$129
2 7/8"	3/4"	61"	55"	EP3WMC61	\$130	\$135	\$145
2 7/8"	3/4"	66"	60"	EP3WMC66	\$133	\$144	\$148
2 7/8"	3/4"	81"	75"	EP3WMC81	\$162	\$168	\$178
2 7/8"	3/4"	120"	120"	EP3WMC120	\$249	\$262	\$276

## Panel Wall Starter

### Specify

1. Model #
2. Paint

### Application Notes

Used to start a run of panels by fastening to an existing wall and attaching a connector assembly to it. Creates 1/4" space from face of wall to centerline of post. Constructed of steel.

**NOTE: Neutral Posture assumes no responsibility for wall construction or performance of fasteners used.**

### Assembly

#### Included

- Panel top & bottom hook
- Panel connector

#### Not Included

- Fasteners to attach to wall

#### Ordered Separately

- Post
- Shrouds

### Top Cap Styles

3 – Beveled

N – Flat

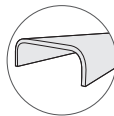
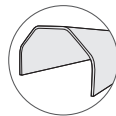

## Wall Mounted Channel

### Specify

1. Model #
2. Paint

### Application Notes

Allows hanging of all components and accessories on reinforced building walls.

**NOTE: Neutral Posture assumes no responsibility for wall construction or performance of fasteners used.**

### Assembly

#### Included

- Extruded aluminum channel

Single Height		PAINT		
H	MODEL #	P1	P2	P3
29"	EP3P29	\$93	\$96	\$99
36"	EP3P36	\$94	\$97	\$100
41"	EP3P41	\$94	\$97	\$100
49"	EP3P49	\$96	\$99	\$102
54"	EP3P54	\$99	\$102	\$105
61"	EP3P61	\$105	\$108	\$111
64"	EP3P64	\$107	\$110	\$113
81"	EP3P81	\$117	\$120	\$123

Dual Height				
H	MODEL #	P1	P2	P3
29"/36"	EP3DP2936	\$155	\$165	\$175
29"/41"	EP3DP2941	\$155	\$165	\$175
29"/49"	EP3DP2949	\$165	\$175	\$185
29"/54"	EP3DP2954	\$165	\$175	\$185
29"/61"	EP3DP2961	\$175	\$185	\$195
29"/66"	EP3DP2966	\$175	\$185	\$195
29"/81"	EP3DP2981	\$195	\$205	\$215
36"/41"	EP3DP3641	\$160	\$170	\$180
36"/49"	EP3DP3649	\$165	\$175	\$185
36"/54"	EP3DP3654	\$165	\$175	\$185
36"/61"	EP3DP3661	\$175	\$185	\$195
36"/66"	EP3DP3666	\$175	\$185	\$195
36"/81"	EP3DP3681	\$195	\$205	\$215
41"/49"	EP3DP4149	\$165	\$175	\$185
41"/54"	EP3DP4154	\$165	\$175	\$185
41"/61"	EP3DP4161	\$175	\$185	\$195
41"/66"	EP3DP4166	\$175	\$185	\$195
41"/81"	EP3DP4181	\$195	\$205	\$215
49"/54"	EP3DP4954	\$165	\$175	\$185
49"/61"	EP3DP4961	\$175	\$185	\$195
49"/66"	EP3DP4966	\$175	\$185	\$195
49"/81"	EP3DP4981	\$195	\$205	\$215
54"/61"	EP3DP5461	\$175	\$185	\$195
54"/66"	EP3DP5466	\$175	\$185	\$195
54"/81"	EP3DP5481	\$195	\$205	\$215
61"/66"	EP3DP6166	\$175	\$185	\$195
61"/81"	EP3DP6181	\$195	\$205	\$215
66"/81"	EP3DP6681	\$195	\$205	\$215

Triple Height		PAINT		
H	MODEL #	P1	P2	P3
29"/36"/41"	EP3TP293641	\$190	\$200	\$210
29"/36"/49"	EP3TP293649	\$190	\$200	\$210
29"/36"/54"	EP3TP293654	\$195	\$205	\$210
29"/36"/61"	EP3TP293661	\$195	\$205	\$210
29"/36"/64"	EP3TP293664	\$195	\$205	\$210
29"/36"/81"	EP3TP293681	\$225	\$235	\$245
29"/41"/49"	EP3TP294149	\$195	\$205	\$215
29"/41"/54"	EP3TP294154	\$195	\$205	\$215
29"/41"/61"	EP3TP294161	\$200	\$210	\$220
29"/41"/64"	EP3TP294164	\$200	\$210	\$220
29"/41"/81"	EP3TP294181	\$230	\$240	\$250
29"/49"/54"	EP3TP294954	\$195	\$205	\$215
29"/49"/61"	EP3TP294961	\$200	\$210	\$220
29"/49"/64"	EP3TP294964	\$200	\$210	\$220
29"/49"/81"	EP3TP294981	\$230	\$240	\$250
29"/54"/61"	EP3TP295461	\$200	\$210	\$220
29"/54"/64"	EP3TP295464	\$200	\$210	\$220
29"/54"/81"	EP3TP295481	\$230	\$240	\$250
29"/61"/64"	EP3TP296164	\$200	\$210	\$220
29"/61"/81"	EP3TP296181	\$230	\$240	\$250
29"/64"/81"	EP3TP296481	\$230	\$240	\$250
36"/41"/49"	EP3TP364149	\$195	\$205	\$215
36"/41"/54"	EP3TP364154	\$195	\$205	\$215
36"/41"/61"	EP3TP364161	\$200	\$210	\$220
36"/41"/64"	EP3TP364164	\$200	\$210	\$220
36"/41"/81"	EP3TP364181	\$230	\$240	\$250
36"/49"/54"	EP3TP364954	\$195	\$205	\$215
36"/49"/61"	EP3TP364961	\$200	\$210	\$220
36"/49"/64"	EP3TP364964	\$200	\$210	\$220
36"/49"/81"	EP3TP364981	\$230	\$240	\$250
36"/54"/61"	EP3TP365461	\$200	\$210	\$220
36"/54"/64"	EP3TP365464	\$200	\$210	\$220
36"/54"/81"	EP3TP365481	\$230	\$240	\$250
36"/61"/64"	EP3TP366164	\$200	\$210	\$220
36"/61"/81"	EP3TP366181	\$230	\$240	\$250
36"/64"/81"	EP3TP366481	\$230	\$240	\$250
41"/49"/54"	EP3TP414954	\$195	\$205	\$215
41"/49"/61"	EP3TP414961	\$200	\$210	\$220
41"/49"/64"	EP3TP414964	\$200	\$210	\$220

Specify
1. Model #
2. Paint

Application Notes
Bottom glides on post allow for up to 1 ½" of vertical adjustment. Specify one multi-height panel connector (EP3PCMF) for each low panel when using either a dual or triple height post in a multi-height connection.
<b>Dual Height Posts</b> Used where 2 monolithic panels of 2 different heights intersect.
<b>Triple Height Posts</b> Used where 3 monolithic panels of 3 different heights intersect.

Assembly
<b>Included</b> • Multi-height post
<b>Ordered Separately</b> • Panel connectors • Metal shrouds



## Triple Height

H	MODEL #	PAINT		
		P1	P2	P3
41"/49"/81"	EP3TP414981	\$230	\$240	\$250
41"/54"/61"	EP3TP415461	\$200	\$210	\$220
41"/54"/64"	EP3TP415464	\$200	\$210	\$220
41"/54"/81"	EP3TP415481	\$230	\$240	\$250
41"/61"/64"	EP3TP416164	\$200	\$210	\$220
41"/61"/81"	EP3TP416181	\$230	\$240	\$250
41"/64"/81"	EP3TP416481	\$230	\$240	\$250
49"/54"/61"	EP3TP495461	\$200	\$210	\$220
49"/54"/64"	EP3TP495464	\$200	\$210	\$220
49"/54"/81"	EP3TP495481	\$230	\$240	\$250
49"/61"/64"	EP3TP496164	\$200	\$210	\$220
49"/61"/81"	EP3TP496181	\$230	\$240	\$250
49"/64"/81"	EP3TP496481	\$230	\$240	\$250
54"/61"/64"	EP3TP546164	\$200	\$210	\$220
54"/61"/81"	EP3TP546181	\$230	\$240	\$250
54"/64"/81"	EP3TP546481	\$230	\$240	\$250
61"/64"/81"	EP3TP616481	\$230	\$240	\$250

## Connectors

DESCRIPTION	MODEL #	PAINT		
		P1	P2	P3
Straight	EP(3/N)PCS	\$37	\$40	\$43
2-way L	EP(3/N)PCL	\$37	\$40	\$43
2-way 120	EP3PC120	\$37	\$40	\$43
2-way adjustable angle	EPNPCA	\$47	\$50	\$53
3-way T	EP(3/N)PCT	\$47	\$50	\$53
3-way Y 120	EP(3/N)PCY	\$47	\$50	\$53
4-way X	EP(3/N)PCX	\$47	\$50	\$53
End with post	EP(3/N)PCEP	\$37	\$40	\$43
Multi-height filler	EP(3/N)PCMF	\$37	\$40	\$43
Trim filler	EPNCTF	\$37	\$40	\$43



Straight



2-way L



2-way  
Adjustable angle



3-way T



3-way Y 120



4-way X



End with post



Multi-height filler



Trim filler

## Metal Shrouds

DESCRIPTION	MODEL #	PAINT		
		P1	P2	P3
Straight	EP3SS	\$27	\$30	\$34
L outside	EP3SL	\$37	\$40	\$44
120 outside	EP3SO120	\$37	\$40	\$44
120 inside	EP3SI120	\$37	\$40	\$44
End w/post	EP3SEP	\$47	\$50	\$54



Straight



L outside



120 outside



120 inside



End w/post

### Specify

1. Model #
2. Paint

### Top Cap Styles

3 - Beveled

N - Flat

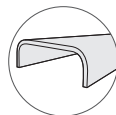
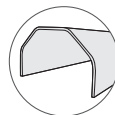

# Stack-On Panels

## COMPONENTS

Equity stack-on panels provide the flexibility to increase the overall height of any standard Equity panel.

The stack-on panel is available in all standard Equity widths and a variety of heights in both slotted and slotless versions.

### STACK-ON PANELS W/ SLOTS

Stack-on panels with slots provide the capability to hang standard Equity components such as shelves and overheads as long as the weight load does not exceed 3lbs. per linear inch.

### STACK-ON PANELS W/O SLOTS

Stack-on panels without slots do not allow for hanging components, but do provide a cleaner aesthetic when specifying window applications.

Up to two (2) load bearing stack-on panels may be stacked on top of a standard Equity panel as long as the total height above the base panels is no taller than 40" and neither individual stack-on panel is taller than 20".

Stack-on panel width must match the width of the panel it is stacking on.

Stack-on panel connectors must be used between adjacent stack-on panels.

## STACK-ON PANEL CONNECTORS

### STANDARD STACK-ON POST

Standard stack-on post bottom uses a conical shaped bolt that connects it to the full height post directly beneath it. Panel connectors for the top of the stack-on post must be ordered separately to match the geometry of the stack-on panels.

### EXTENDED STACK-ON POST

Extended stack-on post bottom uses a double-threaded round connector to attach to the full-height post directly beneath it. Multi-height panel connectors (**EPNPCMF**) must be used on either side of this connector to provide a smooth transition for full-height post covers. Standard panel connectors are used along the top of the stack-on panels.

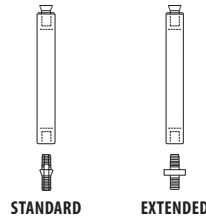

## SPECIFYING STACK-ON CONFIGURATIONS

All connectors between the base panel and Stack-on Panel **MUST** have flat (N) profile.

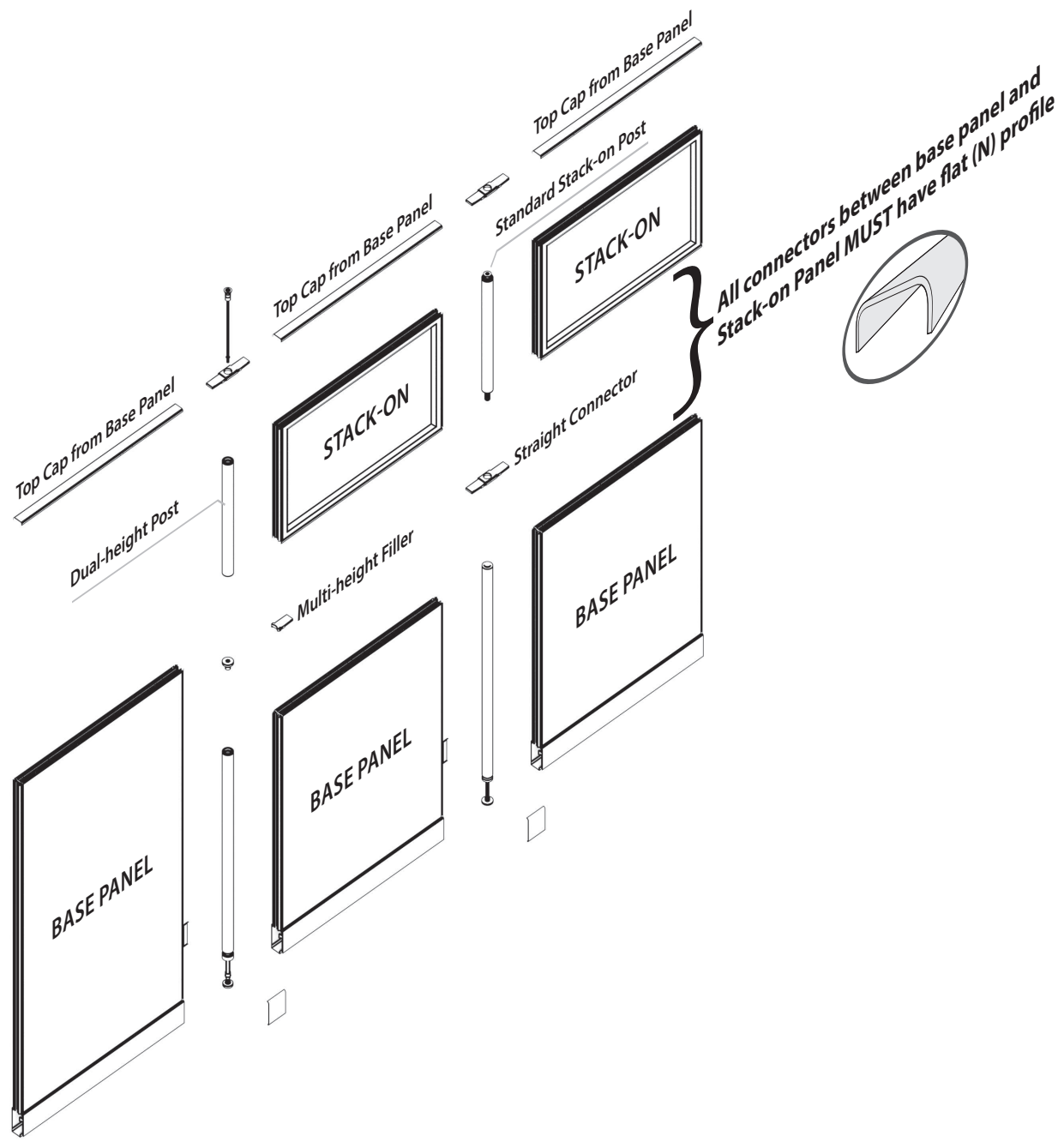

# Stack-On Configurations

Using Standard Stack-on Posts

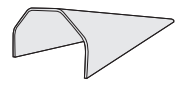
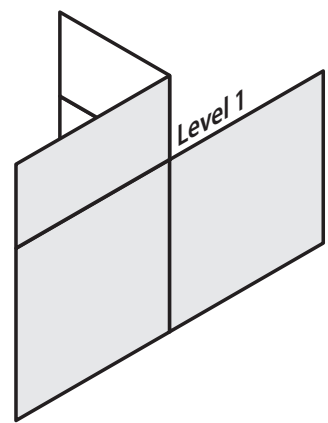
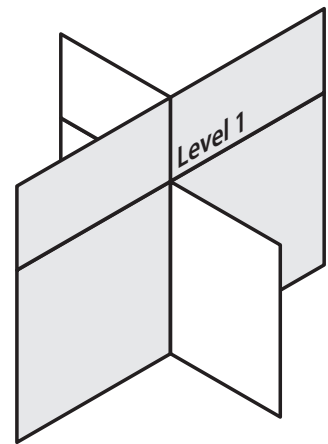
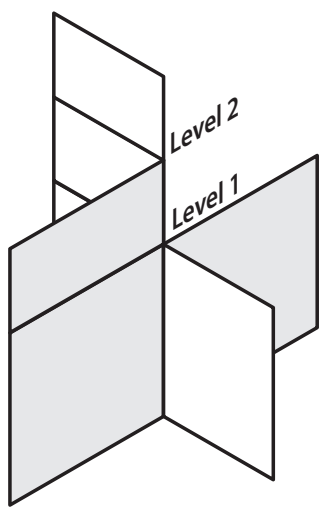

## BEVELED TOP CAP

LEVEL 1

Trim Filler  
EPNCTF

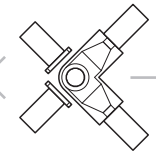

Beveled L  
EP3PCL

LEVEL 2

Trim Filler  
EPNCTF

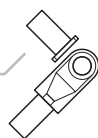

Beveled End w/post  
EP3PCE

LEVEL 1

Trim Filler  
EPNCTF



Flat Multi-height Filler  
EPNCMF

Trim Filler  
EPNCTF

Beveled End w/post  
EP3PCE

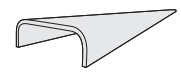

## FLAT TOP CAP

Flat X  
EPNPCX

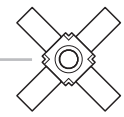

Flat X  
EPNPCX

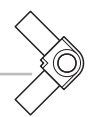

Flat X  
EPNPCX

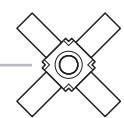

LEVEL 1

Trim Filler  
EPNCTF



Beveled End w/post  
EP3PCE

Flat Multi-height Filler  
EPNCMF

Flat T  
EPNPCT

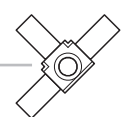

# Stack-On Configurations

Using Standard Stack-on Posts

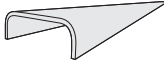
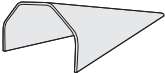

## BEVELED TOP CAP

## FLAT TOP CAP

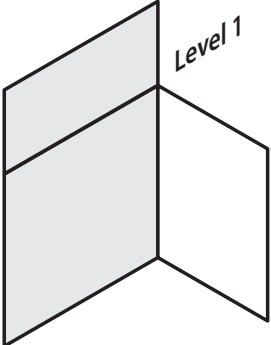

LEVEL 1

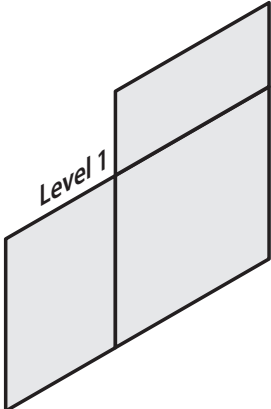
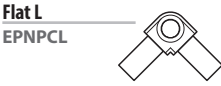
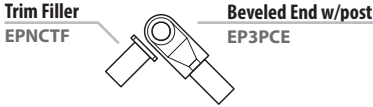

LEVEL 1

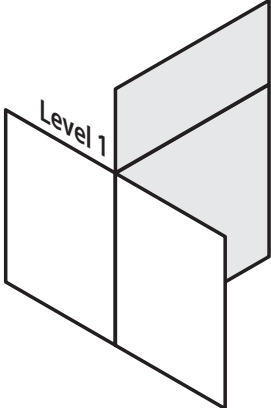
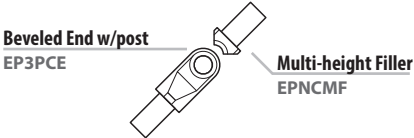

LEVEL 1

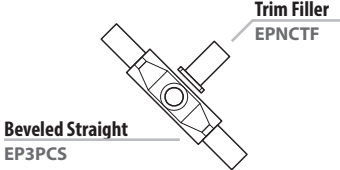

# Stack-on Panels

## Fabric with Slots

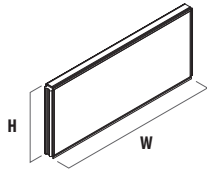

### 12" H

W	MODEL #	FABRIC								PAINT	
		A	B	C	D	E	F	G	H	P2	P3
12"	EP1SF1212	\$400	\$420	\$450	\$490	\$530	\$575	\$625	\$680	+ \$20	+ \$40
18"	EP1SF1812	\$420	\$440	\$470	\$510	\$550	\$595	\$645	\$700	+ \$20	+ \$40
24"	EP1SF2412	\$440	\$460	\$490	\$530	\$570	\$615	\$665	\$720	+ \$20	+ \$40
30"	EP1SF3012	\$460	\$480	\$510	\$550	\$590	\$635	\$685	\$740	+ \$20	+ \$40
36"	EP1SF3612	\$480	\$510	\$550	\$600	\$670	\$750	\$840	\$950	+ \$20	+ \$40
42"	EP1SF4212	\$500	\$530	\$570	\$620	\$690	\$770	\$860	\$970	+ \$20	+ \$40
48"	EP1SF4812	\$520	\$550	\$590	\$640	\$710	\$790	\$880	\$990	+ \$20	+ \$40
60"	EP1SF6012	\$540	\$570	\$610	\$660	\$730	\$810	\$900	\$1,010	+ \$20	+ \$40

### 13" H

12"	EP1SF1213	\$420	\$440	\$470	\$510	\$550	\$595	\$645	\$700	+ \$20	+ \$40
18"	EP1SF1813	\$440	\$460	\$490	\$530	\$570	\$615	\$665	\$720	+ \$20	+ \$40
24"	EP1SF2413	\$460	\$480	\$510	\$550	\$590	\$635	\$685	\$740	+ \$20	+ \$40
30"	EP1SF3013	\$480	\$520	\$570	\$630	\$700	\$790	\$890	\$1,010	+ \$20	+ \$40
36"	EP1SF3613	\$500	\$540	\$590	\$650	\$720	\$810	\$910	\$1,030	+ \$20	+ \$40
42"	EP1SF4213	\$520	\$560	\$610	\$670	\$740	\$830	\$930	\$1,050	+ \$20	+ \$40
48"	EP1SF4813	\$540	\$580	\$630	\$690	\$760	\$850	\$950	\$1,070	+ \$20	+ \$40
60"	EP1SF6013	\$560	\$600	\$650	\$710	\$780	\$870	\$970	\$1,090	+ \$20	+ \$40

### 15" H

12"	EP1SF1215	\$440	\$460	\$490	\$530	\$575	\$625	\$680	\$740	+ \$20	+ \$40
18"	EP1SF1815	\$460	\$480	\$510	\$550	\$595	\$645	\$700	\$760	+ \$20	+ \$40
24"	EP1SF2415	\$480	\$500	\$530	\$570	\$615	\$665	\$720	\$780	+ \$20	+ \$40
30"	EP1SF3015	\$500	\$540	\$590	\$650	\$720	\$820	\$930	\$1,050	+ \$20	+ \$40
36"	EP1SF3615	\$520	\$560	\$610	\$670	\$740	\$840	\$950	\$1,070	+ \$20	+ \$40
42"	EP1SF4215	\$540	\$580	\$630	\$690	\$760	\$860	\$970	\$1,090	+ \$20	+ \$40
48"	EP1SF4815	\$560	\$600	\$650	\$710	\$780	\$880	\$990	\$1,110	+ \$20	+ \$40
60"	EP1SF6015	\$580	\$620	\$670	\$730	\$800	\$900	\$1,010	\$1,130	+ \$20	+ \$40

#### Specify

1. Model #
2. Fabric
3. Paint

#### Assembly

- Included**
- Stack-on panel
  - Flat (N) top cap attached to the bottom of stack-on panel

- Not Included**
- Top cap  
(use top cap from base panel)

- Ordered Separately**
- Stack-on posts
  - Panel connectors

#### Top Cap Styles

3 – Beveled

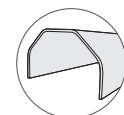

N – Flat

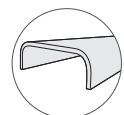

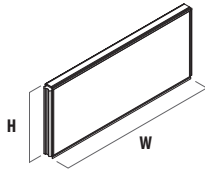

## 17" H

W	MODEL #	FABRIC								PAINT	
		A	B	C	D	E	F	G	H	P2	P3
12"	EP1SF1217	\$460	\$490	\$530	\$575	\$625	\$680	\$740	\$805	+ \$20	+ \$40
18"	EP1SF1817	\$480	\$510	\$550	\$595	\$645	\$700	\$760	\$825	+ \$20	+ \$40
24"	EP1SF2417	\$500	\$530	\$570	\$615	\$665	\$720	\$780	\$845	+ \$20	+ \$40
30"	EP1SF3017	\$520	\$570	\$630	\$700	\$790	\$900	\$1,020	\$1,150	+ \$20	+ \$40
36"	EP1SF3617	\$540	\$590	\$650	\$720	\$810	\$920	\$1,040	\$1,170	+ \$20	+ \$40
42"	EP1SF4217	\$560	\$610	\$670	\$740	\$830	\$940	\$1,060	\$1,190	+ \$20	+ \$40
48"	EP1SF4817	\$580	\$630	\$690	\$760	\$850	\$960	\$1,080	\$1,210	+ \$20	+ \$40
60"	EP1SF6017	\$600	\$650	\$710	\$780	\$870	\$980	\$1,100	\$1,230	+ \$20	+ \$40

## 20" H

12"	EP1SF1220	\$480	\$510	\$550	\$595	\$645	\$700	\$760	\$830	+ \$20	+ \$40
18"	EP1SF1820	\$500	\$530	\$570	\$615	\$665	\$720	\$780	\$850	+ \$20	+ \$40
24"	EP1SF2420	\$520	\$550	\$590	\$635	\$685	\$740	\$800	\$870	+ \$20	+ \$40
30"	EP1SF3020	\$540	\$590	\$650	\$720	\$820	\$950	\$1,090	\$1,240	+ \$20	+ \$40
36"	EP1SF3620	\$560	\$610	\$670	\$740	\$840	\$970	\$1,110	\$1,260	+ \$20	+ \$40
42"	EP1SF4220	\$580	\$630	\$690	\$760	\$860	\$990	\$1,130	\$1,280	+ \$20	+ \$40
48"	EP1SF4820	\$610	\$660	\$720	\$790	\$890	\$1,020	\$1,160	\$1,310	+ \$20	+ \$40
60"	EP1SF6020	\$630	\$680	\$740	\$810	\$910	\$1,040	\$1,180	\$1,330	+ \$20	+ \$40

		Insert Type		W	H
EP1S	Stack-on Panel	F	Fabric	36	20
EP1S		F		36	20

# Stack-on Panels

Fabric without Slots

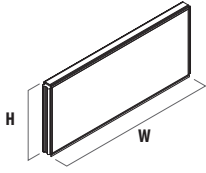

## 12" H

W	MODEL #	FABRIC								PAINT	
		A	B	C	D	E	F	G	H	P2	P3
12"	EP1SF1212N	\$400	\$420	\$450	\$490	\$530	\$575	\$625	\$680	+ \$20	+ \$40
18"	EP1SF1812N	\$420	\$440	\$470	\$510	\$550	\$595	\$645	\$700	+ \$20	+ \$40
24"	EP1SF2412N	\$440	\$460	\$490	\$530	\$570	\$615	\$665	\$720	+ \$20	+ \$40
30"	EP1SF3012N	\$460	\$480	\$510	\$550	\$590	\$635	\$685	\$740	+ \$20	+ \$40
36"	EP1SF3612N	\$480	\$510	\$550	\$600	\$670	\$750	\$840	\$950	+ \$20	+ \$40
42"	EP1SF4212N	\$500	\$530	\$570	\$620	\$690	\$770	\$860	\$970	+ \$20	+ \$40
48"	EP1SF4812N	\$520	\$550	\$590	\$640	\$710	\$790	\$880	\$990	+ \$20	+ \$40
60"	EP1SF6012N	\$540	\$570	\$610	\$660	\$730	\$810	\$900	\$1,010	+ \$20	+ \$40

## 13" H

12"	EP1SF1213N	\$420	\$440	\$470	\$510	\$550	\$595	\$645	\$700	+ \$20	+ \$40
18"	EP1SF1813N	\$440	\$460	\$490	\$530	\$570	\$615	\$665	\$720	+ \$20	+ \$40
24"	EP1SF2413N	\$460	\$480	\$510	\$550	\$590	\$635	\$685	\$740	+ \$20	+ \$40
30"	EP1SF3013N	\$480	\$520	\$570	\$630	\$700	\$790	\$890	\$1,010	+ \$20	+ \$40
36"	EP1SF3613N	\$500	\$540	\$590	\$650	\$720	\$810	\$910	\$1,030	+ \$20	+ \$40
42"	EP1SF4213N	\$520	\$560	\$610	\$670	\$740	\$830	\$930	\$1,050	+ \$20	+ \$40
48"	EP1SF4813N	\$540	\$580	\$630	\$690	\$760	\$850	\$950	\$1,070	+ \$20	+ \$40
60"	EP1SF6013N	\$560	\$600	\$650	\$710	\$780	\$870	\$970	\$1,090	+ \$20	+ \$40

## 15" H

12"	EP1SF1215N	\$440	\$460	\$490	\$530	\$575	\$625	\$680	\$740	+ \$20	+ \$40
18"	EP1SF1815N	\$460	\$480	\$510	\$550	\$595	\$645	\$700	\$760	+ \$20	+ \$40
24"	EP1SF2415N	\$480	\$500	\$530	\$570	\$615	\$665	\$720	\$780	+ \$20	+ \$40
30"	EP1SF3015N	\$500	\$540	\$590	\$650	\$720	\$820	\$930	\$1,050	+ \$20	+ \$40
36"	EP1SF3615N	\$520	\$560	\$610	\$670	\$740	\$840	\$950	\$1,070	+ \$20	+ \$40
42"	EP1SF4215N	\$540	\$580	\$630	\$690	\$760	\$860	\$970	\$1,090	+ \$20	+ \$40
48"	EP1SF4815N	\$560	\$600	\$650	\$710	\$780	\$880	\$990	\$1,110	+ \$20	+ \$40
60"	EP1SF6015N	\$580	\$620	\$670	\$730	\$800	\$900	\$1,010	\$1,130	+ \$20	+ \$40

## 17" H

12"	EP1SF1217N	\$460	\$490	\$530	\$575	\$625	\$680	\$740	\$805	+ \$20	+ \$40
18"	EP1SF1817N	\$480	\$510	\$550	\$595	\$645	\$700	\$760	\$825	+ \$20	+ \$40
24"	EP1SF2417N	\$500	\$530	\$570	\$615	\$665	\$720	\$780	\$845	+ \$20	+ \$40
30"	EP1SF3017N	\$520	\$570	\$630	\$700	\$790	\$900	\$1,020	\$1,150	+ \$20	+ \$40
36"	EP1SF3617N	\$540	\$590	\$650	\$720	\$810	\$920	\$1,040	\$1,170	+ \$20	+ \$40
42"	EP1SF4217N	\$560	\$610	\$670	\$740	\$830	\$940	\$1,060	\$1,190	+ \$20	+ \$40
48"	EP1SF4817N	\$580	\$630	\$690	\$760	\$850	\$960	\$1,080	\$1,210	+ \$20	+ \$40
60"	EP1SF6017N	\$600	\$650	\$710	\$780	\$870	\$980	\$1,100	\$1,230	+ \$20	+ \$40

### Specify

1. Model #
2. Fabric
3. Paint

### Assembly

- Included**
- Stack-on panel
  - Flat (N) top cap attached to the bottom of stack-on panel

- Not Included**
- Top cap  
(use top cap from base panel)

### Ordered Separately

- Stack-on posts
- Panel connectors

### Top Cap Styles

3 – Beveled

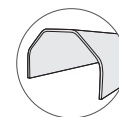

N – Flat





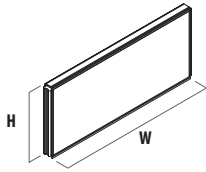

## 20" H

W	MODEL #	FABRIC								PAINT	
		A	B	C	D	E	F	G	H	P2	P3
12"	EP1SF1220N	\$480	\$510	\$550	\$595	\$645	\$700	\$760	\$830	+ \$20	+ \$40
18"	EP1SF1820N	\$500	\$530	\$570	\$615	\$665	\$720	\$780	\$850	+ \$20	+ \$40
24"	EP1SF2420N	\$520	\$550	\$590	\$635	\$685	\$740	\$800	\$870	+ \$20	+ \$40
30"	EP1SF3020N	\$540	\$590	\$650	\$720	\$820	\$950	\$1,090	\$1,240	+ \$20	+ \$40
36"	EP1SF3620N	\$560	\$610	\$670	\$740	\$840	\$970	\$1,110	\$1,260	+ \$20	+ \$40
42"	EP1SF4220N	\$580	\$630	\$690	\$760	\$860	\$990	\$1,130	\$1,280	+ \$20	+ \$40
48"	EP1SF4820N	\$610	\$660	\$720	\$790	\$890	\$1,020	\$1,160	\$1,310	+ \$20	+ \$40
60"	EP1SF6020N	\$630	\$680	\$740	\$810	\$910	\$1,040	\$1,180	\$1,330	+ \$20	+ \$40

## 25" H

12"	EP1SF1225N	\$500	\$530	\$570	\$615	\$675	\$745	\$825	\$915	+ \$20	+ \$40
18"	EP1SF1825N	\$520	\$550	\$590	\$635	\$695	\$765	\$845	\$935	+ \$20	+ \$40
24"	EP1SF2425N	\$540	\$570	\$610	\$655	\$715	\$785	\$865	\$955	+ \$20	+ \$40
30"	EP1SF3025N	\$560	\$610	\$670	\$750	\$880	\$1,030	\$1,190	\$1,360	+ \$20	+ \$40
36"	EP1SF3625N	\$580	\$630	\$690	\$770	\$900	\$1,050	\$1,210	\$1,380	+ \$20	+ \$40
42"	EP1SF4225N	\$600	\$650	\$710	\$790	\$920	\$1,070	\$1,230	\$1,400	+ \$20	+ \$40
48"	EP1SF4825N	\$630	\$680	\$740	\$820	\$950	\$1,100	\$1,260	\$1,430	+ \$20	+ \$40
60"	EP1SF6025N	\$670	\$720	\$780	\$860	\$990	\$1,140	\$1,300	\$1,470	+ \$20	+ \$40

## 32" H

12"	EP1SF1232N	\$520	\$550	\$590	\$635	\$695	\$785	\$885	\$995	+ \$20	+ \$40
18"	EP1SF1832N	\$540	\$570	\$610	\$655	\$715	\$805	\$905	\$1,015	+ \$20	+ \$40
24"	EP1SF2432N	\$560	\$590	\$630	\$675	\$735	\$825	\$925	\$1,035	+ \$20	+ \$40
30"	EP1SF3032N	\$580	\$630	\$690	\$780	\$930	\$1,100	\$1,290	\$1,510	+ \$20	+ \$40
36"	EP1SF3632N	\$600	\$650	\$710	\$800	\$950	\$1,120	\$1,310	\$1,530	+ \$20	+ \$40
42"	EP1SF4232N	\$620	\$670	\$730	\$820	\$970	\$1,140	\$1,330	\$1,550	+ \$20	+ \$40
48"	EP1SF4832N	\$650	\$700	\$760	\$850	\$1,000	\$1,170	\$1,360	\$1,580	+ \$20	+ \$40
60"	EP1SF6032N	\$680	\$730	\$790	\$880	\$1,030	\$1,200	\$1,390	\$1,610	+ \$20	+ \$40

## 37" H

12"	EP1SF1237N	\$540	\$580	\$630	\$690	\$770	\$860	\$960	\$1,070	+ \$20	+ \$40
18"	EP1SF1837N	\$560	\$600	\$650	\$710	\$790	\$880	\$980	\$1,090	+ \$20	+ \$40
24"	EP1SF2437N	\$580	\$620	\$670	\$730	\$810	\$900	\$1,000	\$1,110	+ \$20	+ \$40
30"	EP1SF3037N	\$600	\$670	\$750	\$840	\$1,000	\$1,170	\$1,370	\$1,620	+ \$20	+ \$40
36"	EP1SF3637N	\$620	\$690	\$770	\$860	\$1,020	\$1,190	\$1,390	\$1,640	+ \$20	+ \$40
42"	EP1SF4237N	\$640	\$710	\$790	\$880	\$1,040	\$1,210	\$1,410	\$1,660	+ \$20	+ \$40
48"	EP1SF4837N	\$670	\$740	\$820	\$910	\$1,070	\$1,240	\$1,440	\$1,690	+ \$20	+ \$40
60"	EP1SF6037N	\$700	\$770	\$850	\$940	\$1,100	\$1,270	\$1,470	\$1,720	+ \$20	+ \$40

		Insert Type	W	H	Slots
EP15	Stack-on panel	F Fabric	36	37	N Without slots
EP15		F	36	37	N

# Stack-on Panels

## Insert with Slots

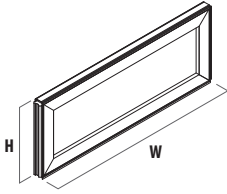

### 12" H

W	MODEL #	GLASS INSERT			LAMINATE INSERT			PAINT	
		DG	GL	PG	L1	L2	L3	P2	P3
12"	EP2S( )1212	\$927	\$707	\$647	\$677	\$745	\$812	+\$20	+\$40
18"	EP2S( )1812	\$957	\$737	\$667	\$697	\$767	\$836	+\$20	+\$40
24"	EP2S( )2412	\$1,002	\$782	\$697	\$732	\$805	\$878	+\$20	+\$40
30"	EP2S( )3012	\$1,052	\$812	\$717	\$752	\$827	\$902	+\$20	+\$40
36"	EP2S( )3612	\$1,107	\$847	\$737	\$777	\$855	\$932	+\$20	+\$40
42"	EP2S( )4212	\$1,157	\$877	\$757	\$797	\$877	\$956	+\$20	+\$40
48"	EP2S( )4812	\$1,197	\$917	\$777	\$827	\$910	\$992	+\$20	+\$40
60"	EP2S( )6012	\$1,327	\$977	\$797	\$877	\$965	\$1,052	+\$20	+\$40

### 13" H

12"	EP2S( )1213	\$967	\$747	\$687	\$717	\$789	\$860	+\$20	+\$40
18"	EP2S( )1813	\$997	\$777	\$707	\$737	\$811	\$884	+\$20	+\$40
24"	EP2S( )2413	\$1,052	\$812	\$727	\$762	\$838	\$914	+\$20	+\$40
30"	EP2S( )3013	\$1,102	\$842	\$747	\$782	\$860	\$938	+\$20	+\$40
36"	EP2S( )3613	\$1,157	\$877	\$767	\$807	\$888	\$968	+\$20	+\$40
42"	EP2S( )4213	\$1,207	\$907	\$787	\$827	\$910	\$992	+\$20	+\$40
48"	EP2S( )4813	\$1,287	\$947	\$807	\$857	\$943	\$1,028	+\$20	+\$40
60"	EP2S( )6013	\$1,397	\$997	\$817	\$897	\$987	\$1,076	+\$20	+\$40

### 15"

12"	EP2S( )1215	\$987	\$767	\$707	\$737	\$811	\$884	+\$20	+\$40
18"	EP2S( )1815	\$1,017	\$797	\$727	\$757	\$833	\$908	+\$20	+\$40
24"	EP2S( )2415	\$1,072	\$832	\$747	\$782	\$860	\$938	+\$20	+\$40
30"	EP2S( )3015	\$1,122	\$862	\$767	\$802	\$882	\$962	+\$20	+\$40
36"	EP2S( )3615	\$1,177	\$897	\$787	\$827	\$910	\$992	+\$20	+\$40
42"	EP2S( )4215	\$1,227	\$927	\$807	\$847	\$932	\$1,016	+\$20	+\$40
48"	EP2S( )4815	\$1,297	\$957	\$817	\$867	\$954	\$1,040	+\$20	+\$40
60"	EP2S( )6015	\$1,417	\$1,017	\$837	\$917	\$1,009	\$1,100	+\$20	+\$40

#### Specify

1. Model #
2. Insert type
3. Insert color
4. Paint

#### Plexiglass Finishes

- CL** . . Clear  
**IC** . . Ice  
**SM** . . Smoked  
**TR** . . Translucent

#### Glass Finishes

- CL** . . Clear  
**GR** . . Grey  
**SM** . . Smoked  
**TR** . . Translucent

#### Assembly

##### Included

- Stack-on panel
- Flat (N) top cap attached to the bottom of stack-on panel

##### Not Included

- Top cap  
(use top cap from base panel)

##### Ordered Separately

- Stack-on posts
- Panel connectors

# Stack-on Panels

Insert with Slots

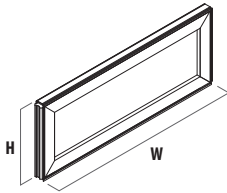

17" H		GLASS INSERT			LAMINATE INSERT			PAINT	
W	MODEL #	DG	GL	PG	L1	L2	L3	P2	P3
12"	EP2S( )1217	\$1,007	\$787	\$727	\$747	\$822	\$896	+ \$20	+ \$40
18"	EP2S( )1817	\$1,057	\$817	\$747	\$777	\$855	\$932	+ \$20	+ \$40
24"	EP2S( )2417	\$1,112	\$852	\$767	\$802	\$882	\$962	+ \$20	+ \$40
30"	EP2S( )3017	\$1,162	\$882	\$787	\$822	\$904	\$986	+ \$20	+ \$40
36"	EP2S( )3617	\$1,217	\$917	\$807	\$847	\$932	\$1,016	+ \$20	+ \$40
42"	EP2S( )4217	\$1,277	\$937	\$817	\$857	\$943	\$1,028	+ \$20	+ \$40
48"	EP2S( )4817	\$1,357	\$977	\$837	\$887	\$976	\$1,064	+ \$20	+ \$40
60"	EP2S( )6017	\$1,477	\$1,037	\$857	\$937	\$1,031	\$1,124	+ \$20	+ \$40

20" H		GLASS INSERT			LAMINATE INSERT			PAINT	
W	MODEL #	DG	GL	PG	L1	L2	L3	P2	P3
12"	EP2S( )1220	\$1,067	\$807	\$747	\$777	\$855	\$932	+ \$20	+ \$40
18"	EP2S( )1820	\$1,097	\$837	\$767	\$797	\$877	\$956	+ \$20	+ \$40
24"	EP2S( )2420	\$1,152	\$872	\$787	\$822	\$904	\$986	+ \$20	+ \$40
30"	EP2S( )3020	\$1,182	\$902	\$807	\$842	\$926	\$1,010	+ \$20	+ \$40
36"	EP2S( )3620	\$1,267	\$927	\$817	\$857	\$943	\$1,028	+ \$20	+ \$40
42"	EP2S( )4220	\$1,337	\$957	\$837	\$877	\$965	\$1,052	+ \$20	+ \$40
48"	EP2S( )4820	\$1,417	\$997	\$857	\$907	\$998	\$1,088	+ \$20	+ \$40
60"	EP2S( )6020	\$1,537	\$1,057	\$877	\$957	\$1,053	\$1,148	+ \$20	+ \$40

		Insert Type	W	H
EP2S	Stack-on panel	DG Designer glass insert GL Glass insert PG Plexiglass insert LM Laminate insert	36	15
EP2S		PG	36	15

Pricing is for P1 paint colors. Add the appropriate upcharge if using P2 or P3 trim.

# Stack-on Panels

## Insert without Slots

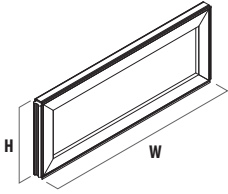

### 12" H

W	MODEL #	GLASS INSERT			LAMINATE INSERT			PAINT	
		DG	GL	PG	L1	L2	L3	P2	P3
12"	EP2S( )1212N	\$927	\$707	\$647	\$677	\$745	\$812	+ \$20	+ \$40
18"	EP2S( )1812N	\$957	\$737	\$667	\$697	\$767	\$836	+ \$20	+ \$40
24"	EP2S( )2412N	\$1,002	\$782	\$697	\$732	\$805	\$878	+ \$20	+ \$40
30"	EP2S( )3012N	\$1,052	\$812	\$717	\$752	\$827	\$902	+ \$20	+ \$40
36"	EP2S( )3612N	\$1,107	\$847	\$737	\$777	\$855	\$932	+ \$20	+ \$40
42"	EP2S( )4212N	\$1,157	\$877	\$757	\$797	\$877	\$956	+ \$20	+ \$40
48"	EP2S( )4812N	\$1,197	\$917	\$777	\$827	\$910	\$992	+ \$20	+ \$40
60"	EP2S( )6012N	\$1,327	\$977	\$797	\$877	\$965	\$1,052	+ \$20	+ \$40

### 13" H

12"	EP2S( )1213N	\$967	\$747	\$687	\$717	\$789	\$860	+ \$20	+ \$40
18"	EP2S( )1813N	\$997	\$777	\$707	\$737	\$811	\$884	+ \$20	+ \$40
24"	EP2S( )2413N	\$1,052	\$812	\$727	\$762	\$838	\$914	+ \$20	+ \$40
30"	EP2S( )3013N	\$1,102	\$842	\$747	\$782	\$860	\$938	+ \$20	+ \$40
36"	EP2S( )3613N	\$1,157	\$877	\$767	\$807	\$888	\$968	+ \$20	+ \$40
42"	EP2S( )4213N	\$1,207	\$907	\$787	\$827	\$910	\$992	+ \$20	+ \$40
48"	EP2S( )4813N	\$1,287	\$947	\$807	\$857	\$943	\$1,028	+ \$20	+ \$40
60"	EP2S( )6013N	\$1,397	\$997	\$817	\$897	\$987	\$1,076	+ \$20	+ \$40

### 15" H

12"	EP2S( )1215N	\$987	\$767	\$707	\$737	\$811	\$884	+ \$20	+ \$40
18"	EP2S( )1815N	\$1,017	\$797	\$727	\$757	\$833	\$908	+ \$20	+ \$40
24"	EP2S( )2415N	\$1,072	\$832	\$747	\$782	\$860	\$938	+ \$20	+ \$40
30"	EP2S( )3015N	\$1,122	\$862	\$767	\$802	\$882	\$962	+ \$20	+ \$40
36"	EP2S( )3615N	\$1,177	\$897	\$787	\$827	\$910	\$992	+ \$20	+ \$40
42"	EP2S( )4215N	\$1,227	\$927	\$807	\$847	\$932	\$1,016	+ \$20	+ \$40
48"	EP2S( )4815N	\$1,297	\$957	\$817	\$867	\$954	\$1,040	+ \$20	+ \$40
60"	EP2S( )6015N	\$1,417	\$1,017	\$837	\$917	\$1,009	\$1,100	+ \$20	+ \$40

### 17" H

12"	EP2S( )1217N	\$1,007	\$787	\$727	\$747	\$822	\$896	+ \$20	+ \$40
18"	EP2S( )1817N	\$1,057	\$817	\$747	\$777	\$855	\$932	+ \$20	+ \$40
24"	EP2S( )2417N	\$1,112	\$852	\$767	\$802	\$882	\$962	+ \$20	+ \$40
30"	EP2S( )3017N	\$1,162	\$882	\$787	\$822	\$904	\$986	+ \$20	+ \$40
36"	EP2S( )3617N	\$1,217	\$917	\$807	\$847	\$932	\$1,016	+ \$20	+ \$40
42"	EP2S( )4217N	\$1,277	\$937	\$817	\$857	\$943	\$1,028	+ \$20	+ \$40
48"	EP2S( )4817N	\$1,357	\$977	\$837	\$887	\$976	\$1,064	+ \$20	+ \$40
60"	EP2S( )6017N	\$1,477	\$1,037	\$857	\$937	\$1,031	\$1,124	+ \$20	+ \$40

#### Specify

1. Model #
2. Insert Type
3. Insert color
4. Paint

#### Plexiglass Finishes

- CL** . . Clear  
**IC** . . Ice  
**SM** . . Smoked  
**TR** . . Translucent

#### Glass Finishes

- CL** . . Clear  
**GR** . . Grey  
**SM** . . Smoked  
**TR** . . Translucent

#### Assembly

##### Included

- Stack-on panel
- Flat (N) top cap attached to the bottom of stack-on panel

##### Not Included

- Top cap  
(use top cap from base panel)

##### Ordered Separately

- Stack-on posts
- Panel connectors

# Stack-on Panels

Insert without Slots

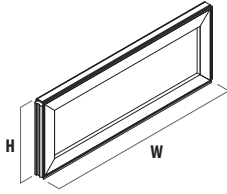

## 20" H

W	MODEL #	GLASS INSERT			LAMINATE INSERT			PAINT	
		DG	GL	PG	L1	L2	L3	P2	P3
12"	EP2S( )1220N	\$1,067	\$807	\$747	\$777	\$855	\$932	+ \$20	+ \$40
18"	EP2S( )1820N	\$1,097	\$837	\$767	\$797	\$877	\$956	+ \$20	+ \$40
24"	EP2S( )2420N	\$1,152	\$872	\$787	\$822	\$904	\$986	+ \$20	+ \$40
30"	EP2S( )3020N	\$1,182	\$902	\$807	\$842	\$926	\$1,010	+ \$20	+ \$40
36"	EP2S( )3620N	\$1,267	\$927	\$817	\$857	\$943	\$1,028	+ \$20	+ \$40
42"	EP2S( )4220N	\$1,337	\$957	\$837	\$877	\$965	\$1,052	+ \$20	+ \$40
48"	EP2S( )4820N	\$1,417	\$997	\$857	\$907	\$998	\$1,088	+ \$20	+ \$40
60"	EP2S( )6020N	\$1,537	\$1,057	\$877	\$957	\$1,053	\$1,148	+ \$20	+ \$40

## 25" H

12"	EP2S( )1225N	\$1,097	\$837	\$777	\$807	\$888	\$968	+ \$20	+ \$40
18"	EP2S( )1825N	\$1,127	\$867	\$797	\$827	\$910	\$992	+ \$20	+ \$40
24"	EP2S( )2425N	\$1,182	\$902	\$817	\$852	\$937	\$1,022	+ \$20	+ \$40
30"	EP2S( )3025N	\$1,232	\$932	\$837	\$872	\$959	\$1,046	+ \$20	+ \$40
36"	EP2S( )3625N	\$1,307	\$967	\$857	\$897	\$987	\$1,076	+ \$20	+ \$40
42"	EP2S( )4225N	\$1,377	\$997	\$877	\$917	\$1,009	\$1,100	+ \$20	+ \$40
48"	EP2S( )4825N	\$1,457	\$1,037	\$907	\$947	\$1,042	\$1,136	+ \$20	+ \$40
60"	EP2S( )6025N	\$1,617	\$1,097	\$937	\$997	\$1,097	\$1,196	+ \$20	+ \$40

## 32" H

12"	EP2S( )1232N	\$1,117	\$857	\$797	\$827	\$910	\$992	+ \$20	+ \$40
18"	EP2S( )1832N	\$1,167	\$887	\$817	\$847	\$932	\$1,016	+ \$20	+ \$40
24"	EP2S( )2432N	\$1,222	\$922	\$837	\$872	\$959	\$1,046	+ \$20	+ \$40
30"	EP2S( )3032N	\$1,312	\$952	\$857	\$892	\$981	\$1,070	+ \$20	+ \$40
36"	EP2S( )3632N	\$1,407	\$987	\$877	\$917	\$1,009	\$1,100	+ \$20	+ \$40
42"	EP2S( )4232N	\$1,497	\$1,017	\$897	\$937	\$1,031	\$1,124	+ \$20	+ \$40
48"	EP2S( )4832N	\$1,587	\$1,067	\$927	\$977	\$1,075	\$1,172	+ \$20	+ \$40
60"	EP2S( )6032N	\$1,757	\$1,157	\$977	\$1,057	\$1,163	\$1,268	+ \$20	+ \$40

## 37" H

12"	EP2S( )1237N	\$1,157	\$877	\$817	\$847	\$932	\$1,016	+ \$20	+ \$40
18"	EP2S( )1837N	\$1,217	\$917	\$837	\$877	\$965	\$1,052	+ \$20	+ \$40
24"	EP2S( )2437N	\$1,317	\$957	\$857	\$907	\$998	\$1,088	+ \$20	+ \$40
30"	EP2S( )3037N	\$1,417	\$997	\$877	\$937	\$1,031	\$1,124	+ \$20	+ \$40
36"	EP2S( )3637N	\$1,517	\$1,037	\$897	\$967	\$1,064	\$1,160	+ \$20	+ \$40
42"	EP2S( )4237N	\$1,597	\$1,077	\$917	\$997	\$1,097	\$1,196	+ \$20	+ \$40
48"	EP2S( )4837N	\$1,687	\$1,127	\$947	\$1,037	\$1,141	\$1,244	+ \$20	+ \$40
60"	EP2S( )6037N	\$1,897	\$1,197	\$997	\$1,097	\$1,207	\$1,316	+ \$20	+ \$40

		Insert Type		W	H	Slots	
EP2S	Stack-on panel	DG	Designer glass insert	36	15	N	w/o Slots
		GL	Glass insert				
		PG	Plexiglass insert				
		LM	Laminate insert				
EP2S		PG		36	15	N	

Pricing is for P1 paint colors. Add the appropriate upcharge if using P2 or P3 trim.

# Stack-on Panels

Perforated Aluminum Insert with Slots

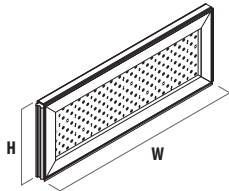

## 12" H

W	MODEL #	PA	INSERT PAINT			PAINT	
			P1	P2	P3	P2	P3
12"	EP2SPA1212	\$647	\$697	\$717	\$737	+\$20	+\$40
18"	EP2SPA1812	\$667	\$717	\$737	\$757	+\$20	+\$40
24"	EP2SPA2412	\$697	\$747	\$767	\$787	+\$20	+\$40
30"	EP2SPA3012	\$717	\$777	\$797	\$817	+\$20	+\$40
36"	EP2SPA3612	\$737	\$797	\$817	\$837	+\$20	+\$40
42"	EP2SPA4212	\$757	\$817	\$837	\$857	+\$20	+\$40
48"	EP2SPA4812	\$777	\$837	\$857	\$877	+\$20	+\$40
60"	EP2SPA6012	\$797	\$877	\$907	\$937	+\$20	+\$40

## 13" H

12"	EP2SPA1213	\$687	\$737	\$757	\$777	+\$20	+\$40
18"	EP2SPA1813	\$707	\$757	\$777	\$797	+\$20	+\$40
24"	EP2SPA2413	\$727	\$787	\$807	\$827	+\$20	+\$40
30"	EP2SPA3013	\$747	\$807	\$827	\$847	+\$20	+\$40
36"	EP2SPA3613	\$767	\$827	\$847	\$867	+\$20	+\$40
42"	EP2SPA4213	\$787	\$847	\$867	\$887	+\$20	+\$40
48"	EP2SPA4813	\$807	\$867	\$887	\$917	+\$20	+\$40
60"	EP2SPA6013	\$817	\$907	\$937	\$977	+\$20	+\$40

## 15"

12"	EP2SPA1215	\$707	\$757	\$777	\$797	+\$20	+\$40
18"	EP2SPA1815	\$727	\$777	\$797	\$817	+\$20	+\$40
24"	EP2SPA2415	\$747	\$797	\$827	\$847	+\$20	+\$40
30"	EP2SPA3015	\$767	\$817	\$857	\$877	+\$20	+\$40
36"	EP2SPA3615	\$787	\$847	\$887	\$907	+\$20	+\$40
42"	EP2SPA4215	\$807	\$867	\$917	\$937	+\$20	+\$40
48"	EP2SPA4815	\$817	\$887	\$947	\$967	+\$20	+\$40
60"	EP2SPA6015	\$837	\$937	\$997	\$1,027	+\$20	+\$40

### Specify

1. Model #
2. Insert color
3. Paint

### Assembly

- Included**
- Stack-on panel
  - Flat (N) top cap attached to the bottom of stack-on panel

### Not Included

- Top cap  
(use top cap from base panel)

### Ordered Separately

- Stack-on posts
- Panel connectors

# Stack-on Panels

Perforated Aluminum Insert with Slots

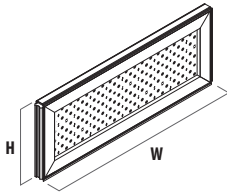

## 17" H

W	MODEL #	PA	INSERT PAINT			PAINT	
			P1	P2	P3	P2	P3
12"	EP2SPA1217	\$727	\$777	\$797	\$817	+ \$20	+ \$40
18"	EP2SPA1817	\$747	\$797	\$817	\$837	+ \$20	+ \$40
24"	EP2SPA2417	\$767	\$827	\$847	\$867	+ \$20	+ \$40
30"	EP2SPA3017	\$787	\$847	\$877	\$897	+ \$20	+ \$40
36"	EP2SPA3617	\$807	\$877	\$907	\$927	+ \$20	+ \$40
42"	EP2SPA4217	\$817	\$897	\$937	\$957	+ \$20	+ \$40
48"	EP2SPA4817	\$837	\$927	\$977	\$997	+ \$20	+ \$40
60"	EP2SPA6017	\$857	\$977	\$1,027	\$1,057	+ \$20	+ \$40

## 20" H

12"	EP2SPA1220	\$747	\$797	\$817	\$837	+ \$20	+ \$40
18"	EP2SPA1820	\$767	\$817	\$837	\$857	+ \$20	+ \$40
24"	EP2SPA2420	\$787	\$837	\$867	\$887	+ \$20	+ \$40
30"	EP2SPA3020	\$807	\$867	\$897	\$917	+ \$20	+ \$40
36"	EP2SPA3620	\$817	\$897	\$937	\$957	+ \$20	+ \$40
42"	EP2SPA4220	\$837	\$917	\$977	\$997	+ \$20	+ \$40
48"	EP2SPA4820	\$857	\$947	\$1,017	\$1,047	+ \$20	+ \$40
60"	EP2SPA6020	\$877	\$1,017	\$1,067	\$1,117	+ \$20	+ \$40

Insert Type		W	H
EP2S Stack-on panel	PA Perforated Aluminum	36	15
EP2S	PA	36	15

# Stack-on Panels

## Perforated Aluminum Insert without Slots

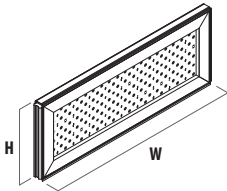

### 12" H

W	MODEL #	PA	INSERT PAINT			PAINT	
			L1	L2	L3	P2	P3
12"	EP2SPA1212N	\$647	\$697	\$717	\$737	+\$20	+\$40
18"	EP2SPA1812N	\$667	\$717	\$737	\$757	+\$20	+\$40
24"	EP2SPA2412N	\$697	\$747	\$767	\$787	+\$20	+\$40
30"	EP2SPA3012N	\$717	\$777	\$797	\$817	+\$20	+\$40
36"	EP2SPA3612N	\$737	\$797	\$817	\$837	+\$20	+\$40
42"	EP2SPA4212N	\$757	\$817	\$837	\$857	+\$20	+\$40
48"	EP2SPA4812N	\$777	\$837	\$857	\$877	+\$20	+\$40
60"	EP2SPA6012N	\$797	\$877	\$907	\$937	+\$20	+\$40

### 13" H

12"	EP2SPA1213N	\$687	\$737	\$757	\$777	+\$20	+\$40
18"	EP2SPA1813N	\$707	\$757	\$777	\$797	+\$20	+\$40
24"	EP2SPA2413N	\$727	\$787	\$807	\$827	+\$20	+\$40
30"	EP2SPA3013N	\$747	\$807	\$827	\$847	+\$20	+\$40
36"	EP2SPA3613N	\$767	\$827	\$847	\$867	+\$20	+\$40
42"	EP2SPA4213N	\$787	\$847	\$867	\$887	+\$20	+\$40
48"	EP2SPA4813N	\$807	\$867	\$887	\$917	+\$20	+\$40
60"	EP2SPA6013N	\$817	\$907	\$937	\$977	+\$20	+\$40

### 15" H

12"	EP2SPA1215N	\$707	\$757	\$777	\$797	+\$20	+\$40
18"	EP2SPA1815N	\$727	\$777	\$797	\$817	+\$20	+\$40
24"	EP2SPA2415N	\$747	\$797	\$827	\$847	+\$20	+\$40
30"	EP2SPA3015N	\$767	\$817	\$857	\$877	+\$20	+\$40
36"	EP2SPA3615N	\$787	\$847	\$887	\$907	+\$20	+\$40
42"	EP2SPA4215N	\$807	\$867	\$917	\$937	+\$20	+\$40
48"	EP2SPA4815N	\$817	\$887	\$947	\$967	+\$20	+\$40
60"	EP2SPA6015N	\$837	\$937	\$997	\$1,027	+\$20	+\$40

### 17" H

12"	EP2SPA1217N	\$727	\$777	\$797	\$817	+\$20	+\$40
18"	EP2SPA1817N	\$747	\$797	\$817	\$837	+\$20	+\$40
24"	EP2SPA2417N	\$767	\$827	\$847	\$867	+\$20	+\$40
30"	EP2SPA3017N	\$787	\$847	\$877	\$897	+\$20	+\$40
36"	EP2SPA3617N	\$807	\$877	\$907	\$927	+\$20	+\$40
42"	EP2SPA4217N	\$817	\$897	\$937	\$957	+\$20	+\$40
48"	EP2SPA4817N	\$837	\$927	\$977	\$997	+\$20	+\$40
60"	EP2SPA6017N	\$857	\$977	\$1,027	\$1,057	+\$20	+\$40

#### Specify

1. Model #
2. Insert color
3. Paint

#### Assembly

- Included**
- Stack-on panel
  - Flat (N) top cap attached to the bottom of stack-on panel

#### Not Included

- Top cap  
(use top cap from base panel)

#### Ordered Separately

- Stack-on posts
- Panel connectors



# Stack-on Panels

Perforated Aluminum Insert without Slots

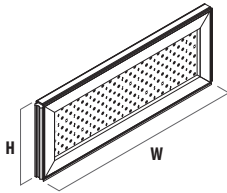

## 20" H

W	MODEL #	PA	INSERT PAINT			PAINT	
			L1	L2	L3	P2	P3
12"	EP2SPA1220N	\$747	\$797	\$817	\$837	+ \$20	+ \$40
18"	EP2SPA1820N	\$767	\$817	\$837	\$857	+ \$20	+ \$40
24"	EP2SPA2420N	\$787	\$837	\$867	\$887	+ \$20	+ \$40
30"	EP2SPA3020N	\$807	\$867	\$897	\$917	+ \$20	+ \$40
36"	EP2SPA3620N	\$817	\$897	\$937	\$957	+ \$20	+ \$40
42"	EP2SPA4220N	\$837	\$917	\$977	\$997	+ \$20	+ \$40
48"	EP2SPA4820N	\$857	\$947	\$1,017	\$1,047	+ \$20	+ \$40
60"	EP2SPA6020N	\$877	\$1,017	\$1,067	\$1,117	+ \$20	+ \$40

## 25" H

12"	EP2SPA1225N	\$777	\$827	\$847	\$867	+ \$20	+ \$40
18"	EP2SPA1825N	\$797	\$847	\$877	\$897	+ \$20	+ \$40
24"	EP2SPA2425N	\$817	\$877	\$907	\$927	+ \$20	+ \$40
30"	EP2SPA3025N	\$837	\$897	\$947	\$967	+ \$20	+ \$40
36"	EP2SPA3625N	\$857	\$927	\$987	\$1,007	+ \$20	+ \$40
42"	EP2SPA4225N	\$877	\$957	\$1,027	\$1,047	+ \$20	+ \$40
48"	EP2SPA4825N	\$907	\$997	\$1,067	\$1,097	+ \$20	+ \$40
60"	EP2SPA6025N	\$937	\$1,077	\$1,117	\$1,157	+ \$20	+ \$40

## 32" H

12"	EP2SPA1232N	\$797	\$847	\$867	\$887	+ \$20	+ \$40
18"	EP2SPA1832N	\$817	\$867	\$897	\$917	+ \$20	+ \$40
24"	EP2SPA2432N	\$837	\$897	\$927	\$947	+ \$20	+ \$40
30"	EP2SPA3032N	\$857	\$947	\$977	\$997	+ \$20	+ \$40
36"	EP2SPA3632N	\$877	\$987	\$1,027	\$1,047	+ \$20	+ \$40
42"	EP2SPA4232N	\$897	\$1,017	\$1,077	\$1,097	+ \$20	+ \$40
48"	EP2SPA4832N	\$927	\$1,047	\$1,127	\$1,147	+ \$20	+ \$40
60"	EP2SPA6032N	\$977	\$1,137	\$1,217	\$1,247	+ \$20	+ \$40

## 37" H

12"	EP2SPA1237N	\$817	\$867	\$887	\$907	+ \$20	+ \$40
18"	EP2SPA1837N	\$837	\$887	\$917	\$937	+ \$20	+ \$40
24"	EP2SPA2437N	\$857	\$917	\$947	\$977	+ \$20	+ \$40
30"	EP2SPA3037N	\$877	\$977	\$1,007	\$1,037	+ \$20	+ \$40
36"	EP2SPA3637N	\$897	\$1,027	\$1,057	\$1,097	+ \$20	+ \$40
42"	EP2SPA4237N	\$917	\$1,057	\$1,107	\$1,157	+ \$20	+ \$40
48"	EP2SPA4837N	\$947	\$1,097	\$1,157	\$1,217	+ \$20	+ \$40
60"	EP2SPA6037N	\$997	\$1,197	\$1,257	\$1,317	+ \$20	+ \$40

Insert Type		W	H	Slots
EP2S	Stack-on panel	36	15	N Without Slots
PA	Perforated Aluminum	36	15	N

Pricing is for P1 paint colors. Add the appropriate upcharge if using P2 or P3 trim.

# Stack-on Posts



## Standard

H	MODEL #	PAINT		
		P1	P2	P3
12"	EP1SPC12	\$125	\$130	\$135
13"	EP1SPC13	\$135	\$140	\$145
15"	EP1SPC15	\$145	\$150	\$155
17"	EP1SPC17	\$155	\$160	\$165
20"	EP1SPC20	\$175	\$185	\$195
25"	EP1SPC25	\$190	\$200	\$210
32"	EP1SPC32	\$200	\$210	\$220
37"	EP1SPC37	\$210	\$220	\$230

Panel connectors must be ordered separately.

## Extended

12"	EP1SPC12E	\$125	\$130	\$135
13"	EP1SPC13E	\$135	\$140	\$145
15"	EP1SPC15E	\$145	\$150	\$155
17"	EP1SPC17E	\$155	\$160	\$165
20"	EP1SPC20E	\$175	\$185	\$195
25"	EP1SPC25E	\$190	\$200	\$210
32"	EP1SPC32E	\$200	\$210	\$220
37"	EP1SPC37E	\$210	\$220	\$230

Panel connectors must be ordered separately.

### Specify

1. Model #
2. Paint

### Application Notes

Stack-on post must be used between adjacent stack-on panels.

### Standard Stack-on

Standard stack-on post bottom uses a conical shaped bolt that connects it to the connector directly beneath it. Panel connectors for the top of the stack-on post must be ordered separately to match the geometry of the stack-on panels.

### Extended Stack-on

Extended stack-on post bottom uses a double-threaded round connector to attach to the full-height post directly beneath it. Multi-height panel connectors (EPNPCMF) must be used on either side of the bottom of this connector to provide a smooth transition. Standard panel connectors are used along the top of the stack-on panels.



### Coat Hook Straight

DESCRIPTION	W	D	H	MODEL #	BLACK OR MATTE ALUM
5 Pack	1/8"	1 3/8"	2 3/8"	EP3MMCH (B/P)	\$141



### Coat Hook Postless End

DESCRIPTION	W	D	H	MODEL #	BLACK OR MATTE ALUM
5 Pack	1 3/8"	3/8"	2 3/8"	EP3MMCHPE (R/L)(B/P)	\$141

#### Specify

1. Model #
2. Paint

#### Coat Hook

Aluminum coat hook attaches to any exposed Equity vertical slot. There are two versions. The straight version will work on any Equity vertical slot except for those on an inside corner. The postless end version is handed and

extends beyond the edge of a panel with a postless end. Hand is determined by which side of the panel the coat hook is installed on while facing the panel.

**Available in two colors**

- Black (B)
- Matte Aluminum (P)

# Frameless Glass

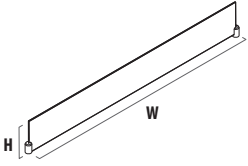

## 8" H

W	H	MODEL #	LIST
12"	8"	EPFLGL1208	\$140
18"	8"	EPFLGL1808	\$190
24"	8"	EPFLGL2408	\$240
30"	8"	EPFLGL3008	\$290
36"	8"	EPFLGL3608	\$340
42"	8"	EPFLGL4208	\$390
48"	8"	EPFLGL4808	\$440
60"	8"	EPFLGL6008	\$490
66"	8"	EPFLGL6608	\$540
72"	8"	EPFLGL7208	\$590

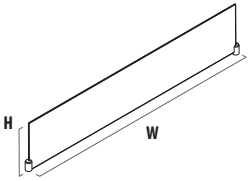

## 12" H

W	H	MODEL #	LIST
12"	12"	EPFLGL1212	\$190
18"	12"	EPFLGL1812	\$250
24"	12"	EPFLGL2412	\$310
30"	12"	EPFLGL3012	\$360
36"	12"	EPFLGL3612	\$410
42"	12"	EPFLGL4212	\$460
48"	12"	EPFLGL4812	\$510
60"	12"	EPFLGL6012	\$560
66"	12"	EPFLGL6612	\$610
72"	12"	EPFLGL7212	\$660

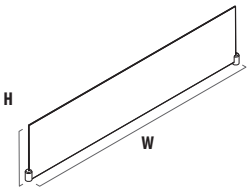

## 14" H

W	H	MODEL #	LIST
12"	14"	EPFLGL1214	\$220
18"	14"	EPFLGL1814	\$300
24"	14"	EPFLGL2414	\$380
30"	14"	EPFLGL3014	\$460
36"	14"	EPFLGL3614	\$540
42"	14"	EPFLGL4214	\$620
48"	14"	EPFLGL4814	\$700
60"	14"	EPFLGL6014	\$780
66"	14"	EPFLGL6614	\$860
72"	14"	EPFLGL7214	\$940

### Specify

1. Model #
2. Glass finish

### Glass Finishes

- CL . . Clear
- GR . . Grey
- SM . . Smoked
- TR . . Translucent

### Application Notes

Glass is a single-pane, 3/8" tempered safety glass. Frameless Glass can span multiple panels with one piece of glass.

### Assembly

**Not Included**  
• Attachment connectors

Top Cap		Type		W	H
EP	Equity Panel	FL	Frameless	48	12
EP		FL		48	12
		GL	Glass		

## Frameless Connectors

DESCRIPTION	MODEL #	PAINT		
		P1	P2	P3
Straight	EPFLCS	\$60	\$66	\$72
2-way L	EPFLCL	\$65	\$72	\$78
3-way T	EPFLCT	\$65	\$72	\$78
3-way Y 120	EPFLCY	\$65	\$72	\$78
4-way X	EPFLCX	\$65	\$72	\$78
End	EPFLCE	\$60	\$66	\$72

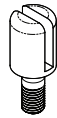

Straight  
EPFLCS

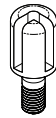

2-way L  
EPFLCL

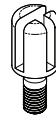

3-way T  
EPFLCT

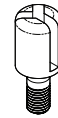

3-way Y 120  
EPFLCY

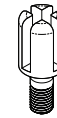

4-way X  
EPFLCX

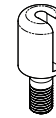

End  
EPFLCE

### Specify

1. Model #
2. Paint

### Application Notes

Frameless glass mounts to panels on either end thru connectors that screw into the top of the panel's posts.

### Assembly

#### Included

- Attachment hardware

Top Cap		Type		W			
EP	Equity panel	FL	Frameless	C	Connector	S	Straight
						L	2-way L
						T	3-way T
						Y	3-way Y
						X	4-way X
						E	End
EP		FL		C		S	

# Add-On Screens

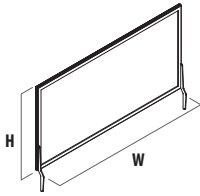

## Add-on Screens

W	H	MODEL #	PAINT		
			P1	P2	P3
12"	15"	EP3AOPG1215	\$602	\$625	\$643
18"	15"	EP3AOPG1815	\$683	\$706	\$725
24"	15"	EP3AOPG2415	\$709	\$732	\$750
30"	15"	EP3AOPG3015	\$749	\$772	\$786
36"	15"	EP3AOPG3615	\$798	\$820	\$838
42"	15"	EP3AOPG4215	\$885	\$910	\$924
48"	15"	EP3AOPG4815	\$966	\$991	\$1,006
60"	15"	EP3AOPG6015	\$988	\$1,010	\$1,028

### Specify

1. Model #
2. Plexiglass finish
3. Paint

### Plexiglass Finishes

- CL ... Clear
- IC ... Ice
- SM ... Smoked
- TR ... Translucent
- LF ... Frost

### Application Notes

Add-on screens mount on the slotted standard with (2) die cast stanchion brackets that are included.

All attachment hardware is included.

Two add-on screens may not be mounted next to each other on the inside corner of a 90° connection.

Add-on screens are compatible with flat (N) and beveled (3) top caps.

### Assembly

- Included**
- Attachment hardware

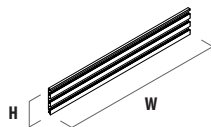

## Slat Rail — panel mounted

W	H	MODEL #	MATTE ALUM	PAINT		
				P1	P2	P3
12"	6"	SR612	\$120	\$150	\$165	\$180
18"	6"	SR618	\$130	\$160	\$176	\$192
24"	6"	SR624	\$150	\$180	\$198	\$216
30"	6"	SR630	\$160	\$190	\$209	\$228
36"	6"	SR636	\$170	\$200	\$220	\$240
42"	6"	SR642	\$180	\$220	\$242	\$264
48"	6"	SR648	\$200	\$240	\$264	\$288
60"	6"	SR660	\$210	\$260	\$286	\$312

## Slat Rail Accessories

DESCRIPTION	MODEL #	MATTE ALUM	PAINT		
			P1	P2	P3
File hanger	SRAFLH	\$70	\$100	\$110	\$120
Paper tray	SRAPAT	\$80	\$110	\$121	\$132
Upright tray	SRAUPT	\$60	\$90	\$99	\$108
Small tray	SRASMT	\$50	\$80	\$88	\$96
Pencil holder	SRAPNH	\$50	\$80	\$88	\$96

### Specify

1. Model #
2. Paint

“E” Series electrical systems consist of a 4-circuit and a 6-circuit system. Each circuit in the systems provides a maximum of 20 amps. The four circuit system has eight wires; the six-circuit system has ten wires. Both 8- and 10-wire systems contain two 10-gauge “super” neutrals and two ground wires so that sensitive electronic equipment may be easily protected from unwanted electrical interference. “E” Series electrical can be connected to either single phase or three-phase building power supplies.

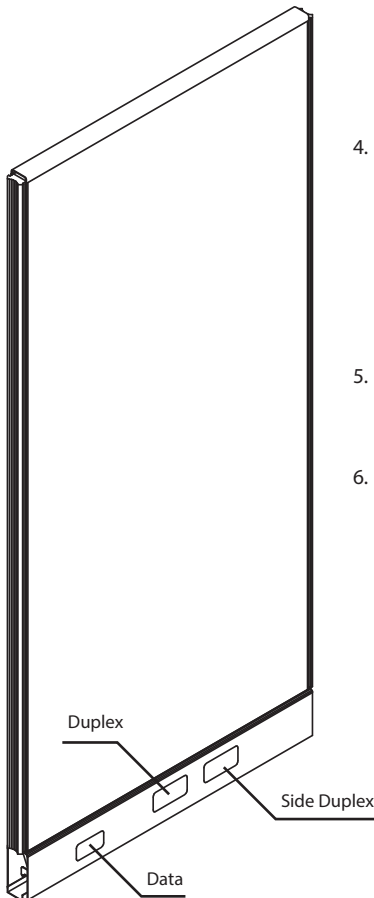

## SPECIFICATION CHECKLIST

The following is a general checklist to ensure your order has been specified properly and to expedite entry of your order. It should be reviewed by a licensed electrician to ensure compliance with any local code requirements.

1. Base or ceiling infeed modules. One for each point of connection to the building power supply. Select model desired. Electrical connection to the building power supply must be made by a licensed electrician to ensure proper installation.
2. Select panels. Conduit jumpers are used to pass power to electrified panels. These panels do not have factory-installed power wiring, but modular power components are field-installed.
3. Shrouds must be used for each panel to panel point to complete the raceway connection. Shrouds are included when post assemblies are ordered. Shrouds can also be ordered separately when building a multiple height connection.
4. Duplex receptacles. Specify the circuit which receptacles are to access: #1, #2, #3 and #4D for 2+2 info eight-wire applications and additionally #5D and #6D for ten wire applications. If connecting to single-phase supply, do not order #2 and #5D receptacles.
5. Select and order appropriate conduit jumpers to pass power between panels.
6. Conduit Jumpers are for regular panel to panel connections or used to pass power through panels from terminal block to terminal block, which can be located up to 12 feet apart.

## Calculate Correct Jumper Length

- 1) Add widths of both panels containing terminal blocks.
- 2) Divide by 2.
- 3) Add width of any non-electrified panels in-between. The result is the correct jumper length.

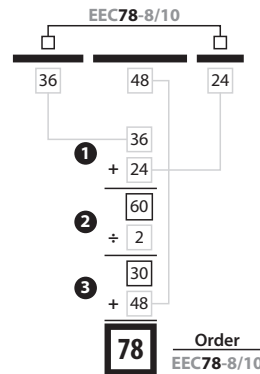

7. Modular wiring components. Internal panel wiring is fully modular and is field-installed into the raceway of panels. When wiring is field-installed the following components must be specified:

### A. Terminal blocks

To branch circuits, splice jumpers or locate receptacles. Blocks snap-lock into place and are always located in the center of a panel. Panels have one block location only. Base infeed and ceiling infeed modules are each designed to plug into a terminal block, which must be ordered separately from the infeed.

### B. Duplex Receptacles

Always specified separately according to circuit access.

### C. Side Mount Receptacles

Available for panels 24" and wider. All standard receptacles fit into side mount position on right side of terminal block connector end. Therefore, no circuit number restriction.

## SPECIAL CONSIDERATIONS

In addition to the checklist the following points should be remembered when planning a layout utilizing this electrical distribution system.

1. “E” Series electrical consists of four or six 20-amp circuits, any of which can be accessed as desired by plugging in a specially numbered receptacle at terminal block locations in panels.
2. Electrified panels can be interspersed between non-electrified panels with the use of extra-length jumpers which pass circuitry to the next electrified panel.
3. For isolation, the 2nd ground must be properly and separately grounded to the building by the installing licensed electrician.
4. Certain cities or localities carry special codes limiting the use of certain items within this system. Equity products are available which comply with these code requirements. Neutral Posture recommends contacting your local sales representative for clarification and possible restrictions.

Because of our continuous product improvements, these specifications are subject to change without notice. Please consult your sales representative for the latest information prior to ordering.



# ELECTRICAL

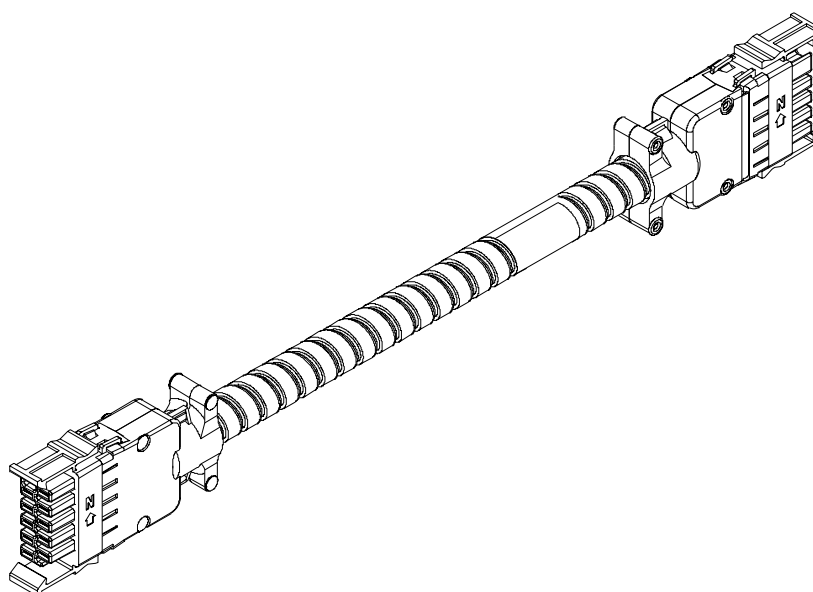

## BASE INFEED MODULE

Modular base-mounted infeed conduits in eight-wire and ten-wire versions are provided for connection to building power supplies housed in underfloor outlet boxes, floor mounted (monuments) or wall outlet boxes. Available “unhanded” for ease in introducing power from left or right of infeed location. The cover plates provided by others, for floor monuments, recessed floor boxes or wall boxes are to be punched to receive a half-inch (trade size) knockout hole for installation of the box fitting, which is included on the infeed circuit. The wiring connection is to be made within the box inside the monument or behind the floor or wall flush plate. The 4' 6" conduit can be shortened to meet field conditions by cutting the infeed (loose) end. Base Infeed Module plugs into terminal block at the receptacle location. For New York and San Francisco base infeed, see page 63.

Connecting to the building power source must be performed by a licensed electrician.

## CEILING INFEED MODULE

The straight tubular infeed may be shortened (on its bottom end) if it will not fit field conditions. ceiling infeed module is filled with 8- or 10- wire conduit and plugs into terminal block in adjacent panel. Harness length is 19'. Upper tube of module is 6' 7" in length.

### RACEWAY PANELS WITH FIELD-INSTALLED COMPONENTRY:

1. An independent cableway with capacity for up to ten ¾" dia. communications cables.
2. A terminal block at the center of the panel allows for jumpers to connect panel to panel electrical connections and placement of duplex receptacles.
3. Terminal block allows for receptacles in two locations, one on each side of the center of the panel (back to back), into which duplex 15-amp receptacles can be placed. The raceway covers are provided with removable knockouts.
4. For increased electric demands a second duplex receptacle per panel side can be added to panels 24" and wider. This receptacle plugs directly into the right side terminal block connector ends. Any standard “E” Series receptacle may be used.
5. The faceplates on both sides of the panel are removable without removing receptacles.

The system and all standard components are UL-listed. Because of our continuous product improvements, these specifications are subject to change without notice. Please consult a Neutral Posture sales representative for the latest information prior to ordering.

### CABLE CAPACITY

FILL	100%	40%
Cat 5	35	14
Cat 6	28	11

## 8-WIRE SYSTEM

### 2 + 2

The 2+2 electrical system consists of four 20 amp, 120 volt, 60-Hertz circuits. These circuits will accommodate 120 volt single phase, 120/240 volt split phase and 120/208 volt three phase power. The system components have a 20 amp capacity. The (NEC) only allows steady loads to 80% of capacity which is equivalent to 16 amps. Each circuit can generally power 8 – 10 duplex convenience outlets that are performing a normal load. However, in heavy load situations, such as computer systems each circuit will power 3 – 5 duplex outlets.

### 3 + 1

The 3+1 electrical system consists of four 20 amp, 120 volt, 60-Hertz circuits. These circuits will power a 120 volt single phase, a 120/240 volt split and a 120/208 volt three phase power. Each system components have the capacity to power 20 amp. The National Electric Code (NEC) only allows steady loads to 80% of capacity which is equivalent to 16 amps. Each circuit can generally power 8-10 duplex convenience outlets that are performing a normal load. However, in heavy load situations, such as computer systems each circuit will power 3 – 5 duplex outlets. If each workstation has two convenience duplex outlets and one protected duplex, the 8-wire (4-circuit) system can supply a cluster of 6 – 10 workstations from each infeed.

## 10-WIRE SYSTEM

### 3 + 3

The 3+3 electrical system consists of six 20 amp, 120 volt, 60-Hertz circuits. The circuits will accommodate 120 volt single phase, 120/240 volt split phase and 120/208 volt three phase power. Each system components have the capacity to power 20 amp. The National Electric Code (NEC) only allows steady loads to 80% of capacity which is equivalent to 16 amps. Each circuit can generally power 8 – 10 duplex convenience outlets that are performing a normal load. However, in heavy load situations, such as computer systems each circuit will power 3 – 5 duplex outlets. If each workstation has two convenience duplex outlets and one protected duplex, the 10-wire (6-circuit) system can supply a cluster of 9 – 15 workstations from each infeed.

### 2 + 2

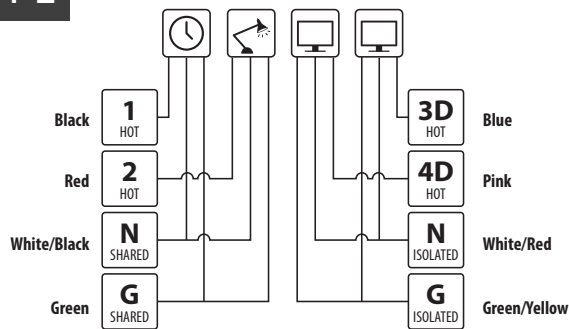

### 3 + 3

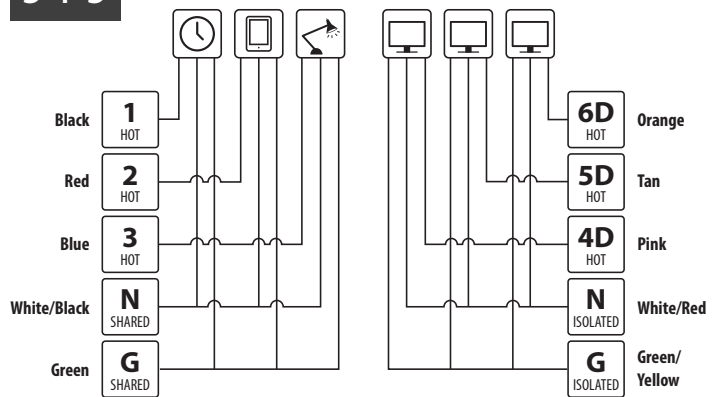

### 3 + 1

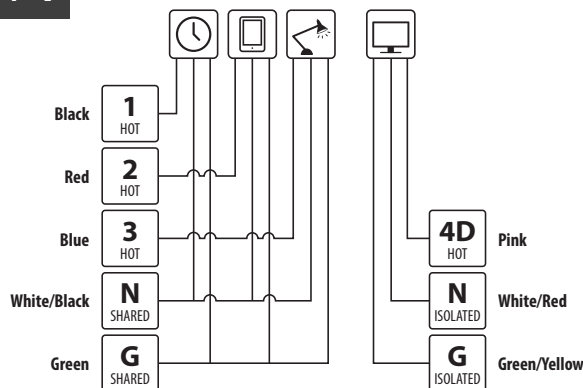

## COMPATIBILITY

Equity power systems use similar components in all electrical systems. However, all parts are

not functionally interchangeable and should be used based on instructions given.



**Ceiling Infeeds**

W	D	H	MODEL #	PAINT		
				P1	P2	P3
4"	1 1/2"	120"	EE3CM41M	\$625	\$656	\$689
4"	1 1/2"	120"	EE3CM49M	\$625	\$656	\$689
4"	1 1/2"	120"	EE3CM54M	\$625	\$656	\$689
4"	1 1/2"	120"	EE3CM61M	\$625	\$656	\$689
4"	1 1/2"	120"	EE3CM66M	\$625	\$656	\$689
4"	1 1/2"	120"	EE3CM81M	\$625	\$656	\$689

**Ceiling Infeed Harness**

DESCRIPTION	MODEL #	LIST
E-Series 10-wire	EE1CH-10	\$573
E-Series 8-wire	EE1CH-8	\$470

**Specify**

1. Model #
  2. Paint
- Fabric cover modules are not available

**Configurations**

- 8-wire**  
2 + 2  
3 + 1
- 10-wire**  
3 + 3

**Application Notes**

To connect a metal ceiling infeed to a corner or straight connection use an adjustable angle connector or an adjustable angle connector with multi-height connector for a three-way connection.

**Ceiling Infeeds**

Electrical harnesses not included with modules. Modules are hollow to accommodate power and/or data cables from source into systems furniture.

With electrical harness installed, infeed holds 28 Cat 6 cables.

No "hang on" capabilities. Module cannot be used for panel support.

Powder coated module is 120" long metal extrusion with attachment hooks at proper height to attach to appropriate height post.

Cables/conduit are laid into module by removal of two-piece front 1 1/2" wide vertical access cover which runs the length of the extrusion.

Includes escutcheon plate which is white to integrate with ceiling. Tube is trim colored to match system trim.

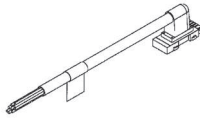

### Base Infeeds

DESCRIPTION	W	MODEL #	LIST
8-wire (right handed)	54"	EE1BI-8	\$244
8-wire (right handed)	72"	EE1BI72-8	\$301
10-wire (right handed)	54"	EE1BI-10	\$295
10-wire (right handed)	72"	EE1BI72-10	\$358
8-wire (left handed)	54"	EE1BI-8-L	\$244
8-wire (left handed)	72"	EE1BI72-8-L	\$301
10-wire (left handed)	54"	EE1BI-10-L	\$295
10-wire (left handed)	72"	EE1BI72-10-L	\$358

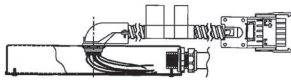

### Base Infeeds – New York

10-wire		EE1BI-10N	\$371
8-wire		EE1BI-8N	\$304

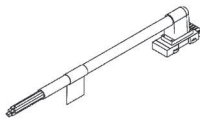

### Base Infeeds – San Francisco

8-wire (non-handed)	54"	EE1BI-8SF	\$244
8-wire (non-handed)	72"	EE1BI72-8SF	\$301
10-wire (non-handed)	54"	EE1BI-10SF	\$295
10-wire (non-handed)	72"	EE1BI72-10SF	\$358

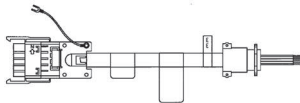

### Jumper End Base Infeeds

10-wire w/ground	72"	EE1BIJ-10G	\$411
8-wire w/ground	72"	EE1BIJ-8G	\$340
8-wire	72"	EE1BIJ-8	\$313
10-wire	72"	EE1BIJ-10	\$386

#### Configurations

**8-wire**  
2 + 2  
3 + 1

**10-wire**  
3 + 3

#### Base Infeeds

An infeed conduit connects to the wall or floor outlet box of a building's power supply and plugs into a terminal block in panel raceway. Power entry can be from either left or right side of panel. Metal cover conceals the baseboard connection and is reversible for either left or right entry. Can be field-cut to proper lengths. Color is black. A terminal block must be ordered separately.

#### Jumper End Base Infeeds

Connects by hardwiring to a building's electrical supply in floor or wall box by a licensed electrician. Plugs into one set of terminal connections at end of terminal block. Terminal block must be located in panel adjacent to source. Terminal block is ordered separately.

Base infeed can be field cut by a licensed electrician to necessary length. Conduit is encased in black plastic sealer.



### Terminal Block

DESCRIPTION	MODEL #	8-WIRE		10-WIRE	
8-wire or 10-wire	EE1TB(8/10)		\$56		\$72



### Duplex Receptacle

DESCRIPTION	MODEL #	8-WIRE		10-WIRE	
		(3+1)	(2+2)	(3+3)	
Circuit #1	EE1R1	\$50	\$50	\$50	
Circuit #2	EE1R2	\$50	\$50	\$50	
Circuit #3 dedicated for 2+2	EE1R3D	N/A	\$50	N/A	
Circuit #3 for 3+1	EE1R3	\$50	N/A	\$50	
Circuit #4 dedicated circuit for 3+1, 2+2 or 3+3	EE1R4D	\$50	\$50	\$50	
Circuit #5 dedicated circuit for 3+3	EE1R5D	N/A	N/A	\$50	
Circuit #6 dedicated circuit for 3+3	EE1R6D	N/A	N/A	\$50	



### Duplex Receptacle (10 Pack)

Circuit #1	EE1R1 P10	\$411	\$411	\$411
Circuit #2	EE1R2 P10	\$411	\$411	\$411
Circuit #3 dedicated for 2+2	EE1R3D P10	N/A	\$411	N/A
Circuit #3 for 3+1	EE1R3 P10	\$411	N/A	\$411
Circuit #4 dedicated circuit for 3+1, 2+2 or 3+3	EE1R4D P10	\$411	\$411	\$411
Circuit #5 dedicated circuit for 3+3	EE1R5D P10	N/A	N/A	\$411
Circuit #6 dedicated circuit for 3+3	EE1R6D P10	N/A	N/A	\$411

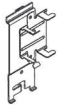

### Receptacle – Side Mount

10 Pack	EE1SMRB10	\$250	\$250	\$250
---------	-----------	-------	-------	-------

### Data Shield

Terminal block shield	EE15BR	\$77	\$77	\$77
-----------------------	--------	------	------	------



### Knock-out Replacement Cover

DESCRIPTION	MODEL #	LIST
10 Pack	EE1KC10	\$68

#### Application Notes

Receptacles are black only.

#### Terminal Block

A modular eight or ten wire block that snaps into the base location in center of the panel. Used to branch circuits, splice jumpers or locate duplex receptacles back to back.

#### Side Mount Receptacles

Plugs directly into the right side of terminal block to provide a second duplex receptacle where required.

Any "E" Series receptacle can be used in panels 24" wide and wider. Side mount receptacle bracket (EE1SMRB10) is needed when using a side mount receptacle.

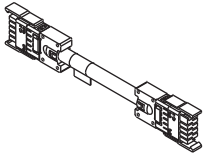

## Jumper

LENGTH (NOMINAL)	LENGTH (ACTUAL)	MODEL #	8-WIRE	10-WIRE
18"	11 1/2"	EE1C18-(8/10)	\$109	\$129
21"	14 1/2"	EE1C21-(8/10)	\$113	\$132
24"	17 1/2"	EE1C24-(8/10)	\$116	\$135
27"	20 1/2"	EE1C27-(8/10)	\$117	\$144
30"	23 1/2"	EE1C30-(8/10)	\$120	\$146
33"	26 1/2"	EE1C33-(8/10)	\$123	\$152
36"	29 1/2"	EE1C36-(8/10)	\$124	\$154
39"	32 1/2"	EE1C39-(8/10)	\$130	\$161
42"	35 1/2"	EE1C42-(8/10)	\$133	\$166
45"	38 1/2"	EE1C45-(8/10)	\$136	\$168
48"	41 1/2"	EE1C48-(8/10)	\$141	\$170
51"	44 1/2"	EE1C51-(8/10)	\$146	\$178
54"	47 1/2"	EE1C54-(8/10)	\$146	\$178
57"	50 1/2"	EE1C57-(8/10)	\$154	\$185
60"	53 1/2"	EE1C60-(8/10)	\$157	\$190
63"	56 1/2"	EE1C63-(8/10)	\$162	\$193
66"	59 1/2"	EE1C66-(8/10)	\$165	\$201
69"	62 1/2"	EE1C69-(8/10)	\$165	\$201
72"	65 1/2"	EE1C72-(8/10)	\$170	\$207
75"	68 1/2"	EE1C75-(8/10)	\$172	\$210
78"	71 1/2"	EE1C78-(8/10)	\$174	\$216
81"	74 1/2"	EE1C81-(8/10)	\$177	\$217
84"	77 1/2"	EE1C84-(8/10)	\$178	\$219
87"	80 1/2"	EE1C87-(8/10)	\$186	\$229
90"	83 1/2"	EE1C90-(8/10)	\$190	\$232
93"	86 1/2"	EE1C93-(8/10)	\$192	\$235
96"	89 1/2"	EE1C96-(8/10)	\$199	\$241
99"	92 1/2"	EE1C99-(8/10)	\$202	\$244
102"	95 1/2"	EE1C102-(8/10)	\$205	\$249
105"	98 1/2"	EE1C105-(8/10)	\$207	\$253
108"	101 1/2"	EE1C108-(8/10)	\$208	\$254
111"	104 1/2"	EE1C111-(8/10)	\$216	\$259
114"	107 1/2"	EE1C114-(8/10)	\$220	\$266
120"	113 1/2"	EE1C120-(8/10)	\$230	\$278
126"	119 1/2"	EE1C126-(8/10)	\$234	\$283
132"	125 1/2"	EE1C132-(8/10)	\$238	\$292
144"	137 1/2"	EE1C144-(8/10)	\$253	\$307

### Configurations

#### 8-wire

2 + 2  
3 + 1

#### 10-wire

3 + 3

### Application Notes

Jumpers transmit power circuits from one panel mounted terminal block to another. Can carry power through panels where no terminal blocks are installed. The length of the jumper corresponds to the distance between the terminal blocks.

### Calculate the Correct Length

1. Add widths of both panels containing terminal blocks.
2. Divide by two.
3. Add width of any non-electrified panels in-between.

The result is the correct jumper length.

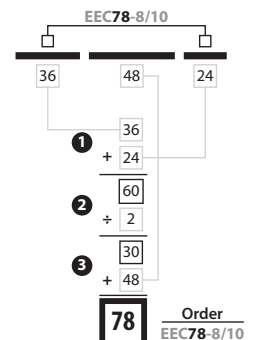



### Terminal Block

MODEL #	LIST
EE1TB-(N3/N4)	\$72



### Duplex Receptacles

EE1RIIN	\$58
EE1RIIN	\$58
EE1RIN	\$58
EE1RIVN	\$58



### Duplex Receptacles (10 pack)

EE1RIIN P10	\$437
EE1RIIN P10	\$437
EE1RIN P10	\$437
EE1RIVN P10	\$437

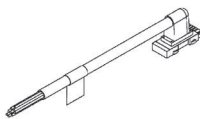

### Base Infeeds

NOMINAL LENGTH	MODEL #	LIST
54"	EE1BI-(N3/N4)	\$312
72"	EE1BI72-(N3/N4)	\$330

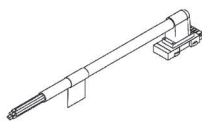

### Base Infeeds – San Francisco

54"	EE1BI-(N3/N4)SF	\$312
72"	EE1BI72-(N3/N4)SF	\$330

### Ceiling Infeed Harness

DESCRIPTION	MODEL #	LIST
E-Series 8-wire	EE1CH-N3	\$683
E-Series 10-wire	EE1CH-N4	\$817

#### Specification Information

##### 8-wire N3

8-wire N3 = 2+1 system (2 hots and 2 neutrals sharing one ground, 1 isolated hot and 1 isolated neutral on an isolated ground)

##### 10-wire N4

10-wire N4 = 2+2 system (2 hots and 2 neutrals sharing one ground, 2 hots and 2 neutrals sharing another ground)

#### Application Notes

##### Jumpers

Transmit power circuits from one panel mounted terminal block to another. Can carry power through panels where no terminal blocks are installed. The length of the jumper corresponds to the distance between the terminal blocks.

#### Calculate the Correct Length

1. Add widths of both panels containing terminal blocks.
2. Divide by two.
3. Add width of any non-electrified panels in-between.

The result is the correct jumper length.

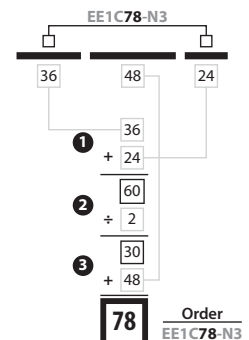



## Jumper

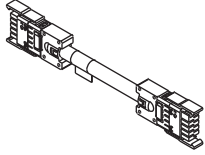

NOMINAL LENGTH	MODEL #	LIST
18"	EE1C18-(N3/N4)	\$133
21"	EE1C21-(N3/N4)	\$141
24"	EE1C24-(N3/N4)	\$145
27"	EE1C27-(N3/N4)	\$152
30"	EE1C30-(N3/N4)	\$157
33"	EE1C33-(N3/N4)	\$161
36"	EE1C36-(N3/N4)	\$162
39"	EE1C39-(N3/N4)	\$167
42"	EE1C42-(N3/N4)	\$174
45"	EE1C45-(N3/N4)	\$178
48"	EE1C48-(N3/N4)	\$179
51"	EE1C51-(N3/N4)	\$187
54"	EE1C54-(N3/N4)	\$187
57"	EE1C57-(N3/N4)	\$193
60"	EE1C60-(N3/N4)	\$202
63"	EE1C63-(N3/N4)	\$206
66"	EE1C66-(N3/N4)	\$208
69"	EE1C69-(N3/N4)	\$208
72"	EE1C72-(N3/N4)	\$219
75"	EE1C75-(N3/N4)	\$223
78"	EE1C78-(N3/N4)	\$227
81"	EE1C81-(N3/N4)	\$230
84"	EE1C84-(N3/N4)	\$232
87"	EE1C87-(N3/N4)	\$241
90"	EE1C90-(N3/N4)	\$244
93"	EE1C93-(N3/N4)	\$247
96"	EE1C96-(N3/N4)	\$253
99"	EE1C99-(N3/N4)	\$255
102"	EE1C102-(N3/N4)	\$259
105"	EE1C105-(N3/N4)	\$266
108"	EE1C108-(N3/N4)	\$267
111"	EE1C111-(N3/N4)	\$277
114"	EE1C114-(N3/N4)	\$280
120"	EE1C120-(N3/N4)	\$293
126"	EE1C126-(N3/N4)	\$298
132"	EE1C132-(N3/N4)	\$305
144"	EE1C144-(N3/N4)	\$322

### Specification Information

#### 8-wire N3

8-wire N3 = 2+1 system (2 hots and 2 neutrals sharing one ground, 1 isolated hot and 1 isolated neutral on an isolated ground)

#### 10-wire N4

10-wire N4 = 2+2 system (2 hots and 2 neutrals sharing one ground, 2 hots and 2 neutrals sharing another ground)

### Application Notes

#### Jumpers

Transmit power circuits from one panel mounted terminal block to another. Can carry power through panels where no terminal blocks are installed. The length of the jumper corresponds to the distance between the terminal blocks.

### Calculate the Correct Length

1. Add widths of both panels containing terminal blocks.
2. Divide by two.
3. Add width of any non-electrified panels in-between.

The result is the correct jumper length.

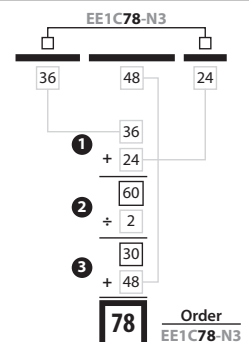

### Charge Spot

DESCRIPTION	MODEL #	LIST
Wireless device charger	AWDC1	\$427
Wireless device charger (4 Pack) w/multi unit power supply	AWDC4	\$1,447



### Charge Spot Dongles

Apple Lightning dongle	AWDCSA	\$77
mUSB dongle	AWDCSU	\$77

### Charge Spot Replacement Power

Single unit power supply	AWDCRPS1	\$57
Multi unit power supply	AWDCRPS4	\$257

---

**Specify**

1. Model #



### Ashley Duo

DESCRIPTION	W	D	H	MODEL #	LIST
120" Cord length	5 1/2"	3 1/8"	2"	EE4WSAD120	\$390
72" Cord length	5 1/2"	3 1/8"	2"	EE4WSAD72	\$380



### Ashley Duo Air

In-worksurface pop-up power	7"		5"	EPUPM72	\$497
-----------------------------	----	--	----	---------	-------

### Ashley Quad

#### Under Worksurface

4 AC outlets, 2 USB, 2 Data	10 7/8"	3 7/8"	1 3/4"	EE4UWSAQ2D72	\$657
4 AC outlets, 2 USB, 2 Data	10 7/8"	3 7/8"	1 3/4"	EE4UWSAQ2D120	\$677

#### Panel Supported

4 AC outlets, 2 USB, 2 Data	10 7/8"	3 7/8"	1 3/4"	EE4PSAQ2D72	\$727
4 AC outlets, 2 USB, 2 Data	10 7/8"	3 7/8"	1 3/4"	EE4PSAQ2D120	\$747

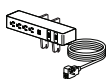
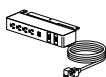

### Desktop Power

108" Cord length	3 3/4"		4 1/2"	EE4WSME108	\$177
72" Cord length	3 3/4"		4 1/2"	EE4WSME72	\$157



### Desktop Data

	3 3/4"	2 1/2"	5"	EE4WSMC	\$133
--	--------	--------	----	---------	-------



### Desktop Power & Data

108" Cord length				EE4WSMED108	\$379
72" Cord length				EE4WSMED72	\$347

#### Ashley Duo

The Ashley duo features two receptacles and dual USB ports in a convenient 2 piece clamp on surface mount.

The USB charging ports provide 2.1 amps per port, 4.2 amps total. They also feature a Smart Device Recognition Chip that monitors the power request from plugged in devices, self-regulating and supplying the appropriate

amps, up to 2.1 amps, as needed by device. The result is each device receives the appropriate amount of power and charges as fast as possible. Accommodates surfaces 1" to 1 3/4" thick.

**Installation**  
Clamps to back of worksurface with included bracketry.

#### Ashley Duo & Air Outer Finishes

**OBLK** . . . . . Black  
**OWHT** . . . . . White  
**OSIL** . . . . . Silver

#### Ashley Duo & Air Face Finishes

**FBLK** . . . . . Black  
**FWHT** . . . . . White  
**FSIL** . . . . . Silver

#### Desktop Modules

Duplex electrical and communications outlets that attach at any point along the rear of a worksurface.

Accommodates surfaces 1" to 1 3/4" thick.

**Installation**  
Clamps to back of worksurface with included bracketry. Available in black only.

#### Data Wiring

Data wiring and keystones provided by customer's cabling contractor.

#### Specify Ashley Duo

1. Model #
2. Outer finish
3. Face finish

# Worksurfaces

## General Info

### Step 1 – Model #

Worksurface Type	W	D	Options		
			Wiring		Extended Ends
EW1 Rectangle	48	24	G Grommets \$25	E One End \$21	
			G2 Scallop \$50	EE Both Ends \$42	
<b>EW1</b>	<b>48</b>	<b>24</b>	<b>G</b>	<b>E</b>	

### Step 2 – Surface Finish

Laminate	
PW-STK	Studio Teak
<b>PW-STK</b>	

### Step 3 – Edge Finish

Edge Band	
EB-STK	Studio Teak
<b>EB-STK</b>	

## FEATURES

### DEPTHS

20"  
24"  
30"  
36"

### WIDTHS

24"  
30"  
36"  
42"  
48"  
54"  
60"  
66"  
72"  
78"  
84"  
90"  
96"  
102"  
108"  
114"  
120"

### THICKNESS

1 1/8"

## WIRING & CABLING

### GROMMET

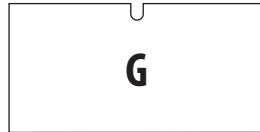

When a standard grommet is specified it is in a rear, centered location and is available in black only. Corner worksurfaces provide two edge grommets.

### SCALLOP



Scalloped grommets feature additional half grommets on either end to provide a full grommet when two tops meet. The half grommet also allows for cord management by itself when it is wrapped by panels and not adjacent to other worksurfaces.

### CABLE DROP

3/8" Cable management gap

## EDGE DETAIL

### STANDARD

3mm ABS

### WOODGRAIN

2mm PVC

## SURFACE MATERIALS

### STANDARD WORKSURFACE

High pressure laminate

### CASCADE WORKSURFACE

Thermafoil (available on Cascade edge only)

### EDGEBAND

Available matching or contrasting. Upcharge may be applicable.

### SUPPORTS

Under worksurface — black powdercoat  
Countercap supports — paint

# WORKSURFACES

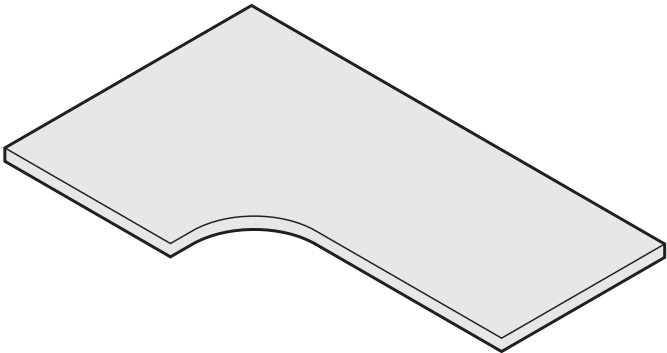

# Worksurface

## General Info

Top surface available in standard laminates. For a complete list of color offering consult the Finishes page (page 14) at the beginning of the price list.

Underside of all 24" deep and deeper rectangular worksurfaces are predrilled for mounting of support bracketry.

The front edge of 30" deep cantilevered surfaces should not be loaded in excess of 180 pounds.

Worksurfaces are designed to provide a 3/8" cable management gap between the back edge of the worksurface and wall panel.

### D & P TOPS

Equity "D" and "P" tops are actual depth plus 1 1/2" to cover two posts and may not be panel wrapped. This allows an adjustable bar support to support the flat end without being visually obtrusive. Adjacent worksurfaces should be specified so as not to cover a post where a "D" or "P" top may be used.

### WORKSURFACE DIMENSIONS

Equity is measured from the center of the posts on each end of the panel. A standard worksurface is dimensioned to fit in a fully panel wrapped configuration. It is therefore 1 1/2" narrower than the nominal panel dimension. If you would like the worksurface to extend to cover one post you will need to add an "E" to the worksurface item number. This will add 1 1/2" to the width of the surface. If you would like the worksurface to extend to cover both posts then you will need to add "EE", extending the surface by 3" from the standard. Adjustable height work surfaces, page 88, are 2" narrower than a standard surface to meet anti-pinch point requirements around their perimeter.

- E . . . Covers 1 post
- EE . . Covers 2 posts

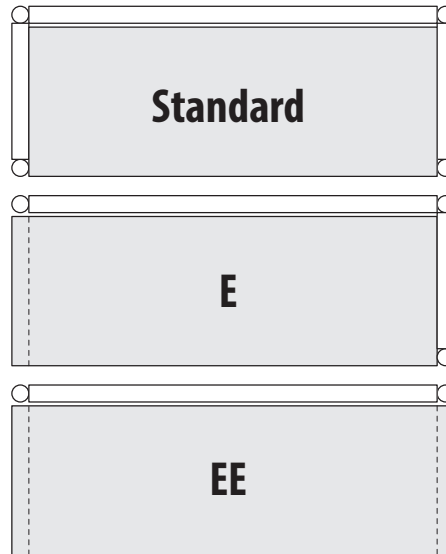

### 24" DEEP STRAIGHTS & 15" TOWERS

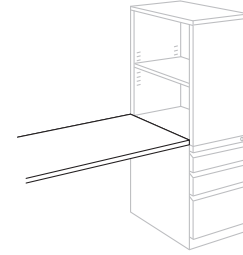

When adding a 15" tower to the end of a worksurface you will need to add a "T" to the end of the model number in order to make the worksurface and tower completely flush. This will only be necessary on 24" deep worksurfaces with a width from 48" – 84".

#### (T) – Available on

W	H	W (actual)	
48"	24"	43 1/4"	<b>EW14824T</b>
54"	24"	49 1/4"	<b>EW15424T</b>
60"	24"	55 1/4"	<b>EW16024T</b>
66"	24"	61 1/4"	<b>EW16624T</b>
72"	24"	67 1/4"	<b>EW17224T</b>
78"	24"	73 1/4"	<b>EW17824T</b>
84"	24"	79 1/4"	<b>EW18424T</b>

### MOUNTING CORNER WORKSURFACES

#### USING ALL CANTILEVERS

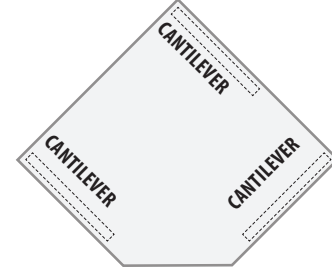

#### USING 2 CANTILEVERS AND 1 PANEL TO WORKSURFACE BRACKET

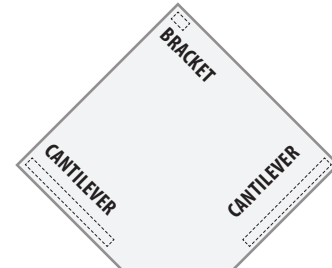

Worksurface Sizes		Cantilever-C		Adjustable Bar Support-S		Supporting Pedestal	Supporting Pedestal
W	D	EB1C20(L/R)		EB1SR(S/L)		24" Deep	30" Deep
24"	20"	200 lbs	2C	200 lbs	2S	N/A	N/A
24"	24"	200 lbs	2C	200 lbs	2S	+1 Support	N/A
30"	20"	200 lbs	2C	200 lbs	2S	N/A	N/A
30"	24"	200 lbs	2C	200 lbs	2S	+1 Support	N/A
30"	30"	200 lbs	2C	200 lbs	2S	—	+1 Support
36"	20"	200 lbs	2C	200 lbs	2S	N/A	N/A
36"	24"	200 lbs	2C	200 lbs	2S	+1 Support	N/A
36"	30"	200 lbs	2C	200 lbs	2S	—	+1 Support
42"	20"	200 lbs	2C	200 lbs	2S	N/A	N/A
42"	24"	200 lbs	2C	200 lbs	2S	+1 Support	N/A
42"	30"	200 lbs	2C	200 lbs	2S	—	+1 Support
48"	20"	216 lbs	2C	216 lbs	2S	N/A	N/A
48"	24"	216 lbs	2C	216 lbs	2S	+1 Support	N/A
48"	30"	216 lbs	2C	216 lbs	2S	—	+1 Support
54"	20"	243 lbs	3C	243 lbs	2S/1C	N/A	N/A
54"	24"	243 lbs	3C	243 lbs	2S/1C	+2 Support	N/A
54"	30"	243 lbs	3C	243 lbs	2S/1C	—	+2 Support
60"	20"	270 lbs	3C	270 lbs	2S/1C	N/A	N/A
60"	24"	270 lbs	3C	270 lbs	2S/1C	+2 Support	N/A
60"	30"	270 lbs	3C	270 lbs	2S/1C	—	+2 Support
66"	20"	297 lbs	3C	297 lbs	2S/1C	N/A	N/A
66"	24"	297 lbs	3C	297 lbs	2S/1C	+2 Support	N/A
66"	30"	297 lbs	3C	297 lbs	2S/1C	—	+2 Support
72"	20"	324 lbs	3C	324 lbs	2S/1C	N/A	N/A
72"	24"	324 lbs	3C	324 lbs	2S/1C	+2 Support	N/A
72"	30"	324 lbs	3C	324 lbs	2S/1C	—	+2 Support
78"	20"	351 lbs	3C	351 lbs	2S/1C	N/A	N/A
78"	24"	351 lbs	3C	351 lbs	2S/1C	+2 Support	N/A
84"	20"	378 lbs	3C	378 lbs	2S/1C	N/A	N/A
84"	24"	378 lbs	3C	378 lbs	2S/1C	+2 Support	N/A
84"	30"	—	—	378 lbs	2S/1C	—	+2 Support
90"	20"	405 lbs	3C	405 lbs	2S/1C	N/A	N/A
90"	24"	405 lbs	3C	405 lbs	2S/1C	+2 Support	N/A
96"	20"	432 lbs	3C	432 lbs	2S/1C	N/A	N/A
96"	24"	432 lbs	3C	432 lbs	2S/1C	+2 Support	N/A
96"	30"	—	—	432 lbs	2S/2C	—	+2 Support
108"	20"	486 lbs	4C	486 lbs	2S/2C	N/A	N/A
108"	24"	486 lbs	4C	486 lbs	2S/2C	+3 Support	N/A
108"	30"	—	—	486 lbs	2S/2C	—	+3 Support
120"	20"	540 lbs	4C	540 lbs	2S/2C	N/A	N/A
120"	24"	540 lbs	4C	540 lbs	2S/2C	+3 Support	N/A
120"	30"	—	—	540 lbs	2S/2C	—	+3 Support

- Support must be installed for every four feet of width. As indicated, 5' worksurfaces require three supports; two panels are required to install the center support.
- The applications shown in the table emphasize the fundamentals of worksurface loading and support. As long as these criteria are met, supports can be interchanged.
- Supporting drawer pedestals can replace only one support.
- Depth of stretchered worksurfaces must be equal to or less than side panel widths.
- Stretchered worksurfaces should be used where heavy loading is anticipated.
- Cantilevers cannot be used as primary support for 36" deep surfaces or 30" deep surfaces wider than 72".
- The front edge of 30" deep surfaces should not be loaded in excess of 180 pounds.

Weights listed are the Business Institutional Furniture Manufacturers Association (BIFMA) functional load requirements for panel hung worksurface loading. If loads larger than these listed are anticipated, approval from Neutral Posture is required.

INSTALLATIONS WHICH VIOLATE THESE REQUIREMENTS WILL NOT BE COVERED BY THE NEUTRAL POSTURE WARRANTY.

Rectangle



Blended Corner



Corner Round



Corner

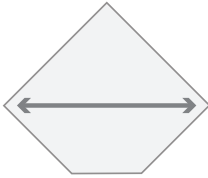
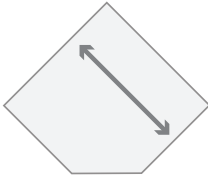
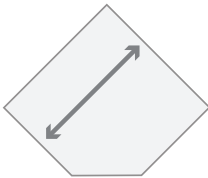

Blended Peninsula

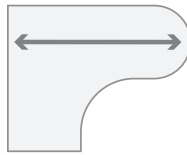

D Top



Blended Double Corner



P/9 Tops

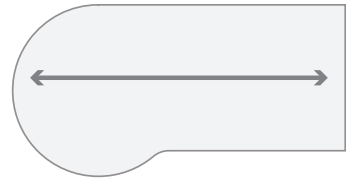

135° Curved Cluster

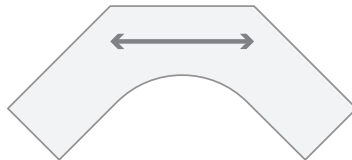

Half Round





**W3**

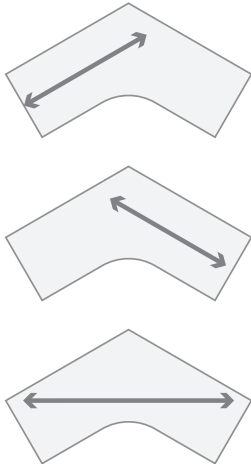

**W6**

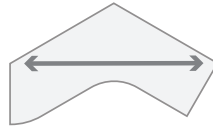

**W13**

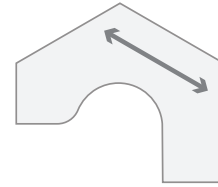

**W7**

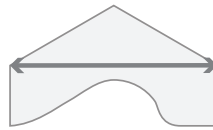

**T3**



**W4**

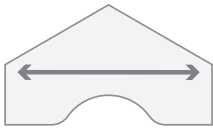

**W11**

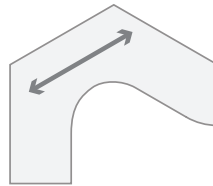

**T4**



**W5**

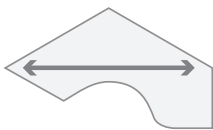

**W12**

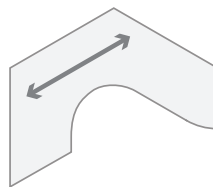

**T5**



# Worksurfaces

## Straights

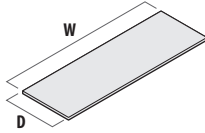

### 20" Deep

W	D	MODEL #	LAMINATE		
			L1	L2	L3
24"	20"	EW12420	\$310	\$341	\$372
30"	20"	EW13020	\$335	\$369	\$402
36"	20"	EW13620	\$365	\$402	\$438
42"	20"	EW14220	\$390	\$429	\$468
48"	20"	EW14820	\$420	\$462	\$504
54"	20"	EW15420	\$445	\$490	\$534
60"	20"	EW16020	\$475	\$523	\$570
66"	20"	EW16620	\$500	\$550	\$600
72"	20"	EW17220	\$510	\$561	\$612
78"	20"	EW17820	\$530	\$583	\$636
84"	20"	EW18420	\$560	\$616	\$672
90"	20"	EW19020	\$585	\$644	\$702
96"	20"	EW19620	\$615	\$677	\$738
102"	20"	EW110220	\$640	\$704	\$768
108"	20"	EW110820	\$670	\$737	\$804
114"	20"	EW111420	\$695	\$765	\$834
120"	20"	EW112020	\$725	\$798	\$870

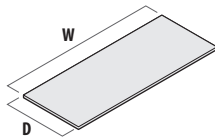

### 24" Deep

24"	24"	EW12424	\$340	\$374	\$408
30"	24"	EW13024	\$360	\$396	\$432
36"	24"	EW13624	\$380	\$418	\$456
42"	24"	EW14224	\$400	\$440	\$480
48"	24"	EW14824	\$420	\$462	\$504
54"	24"	EW15424	\$450	\$495	\$540
60"	24"	EW16024	\$505	\$556	\$606
66"	24"	EW16624	\$555	\$611	\$666
72"	24"	EW17224	\$565	\$622	\$678
78"	24"	EW17824	\$580	\$638	\$696
84"	24"	EW18424	\$590	\$649	\$708
90"	24"	EW19024	\$600	\$660	\$720
96"	24"	EW19624	\$635	\$699	\$762
102"	24"	EW110224	\$670	\$737	\$804
108"	24"	EW110824	\$695	\$765	\$834
114"	24"	EW111424	\$725	\$798	\$870
120"	24"	EW112024	\$750	\$825	\$900

### 24" DEEP STRAIGHTS & 15" TOWERS

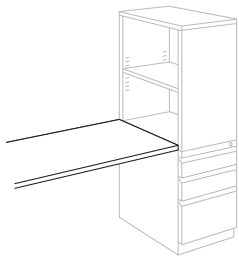

When adding a 15" tower to the end of a work surface you will need to add a "T" to the end of the model number in order to make the work surface and tower completely flush. This will only be necessary on 24" deep work surfaces with a width from 48" – 84".

EW1	Rectangle	W	D	Options					
				Wiring			Extended Ends		
		48	24	G	Grommet	\$25	E	One End	\$21
				G2	Scallop	\$50	EE	Both Ends	\$42
<b>EW1</b>		<b>48</b>	<b>24</b>	<b>G</b>			<b>E</b>		

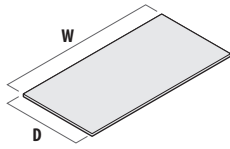

### 30" Deep

W	D	MODEL #	LAMINATE		
			L1	L2	L3
24"	30"	EW12430	\$390	\$429	\$468
30"	30"	EW13030	\$420	\$462	\$504
36"	30"	EW13630	\$445	\$490	\$534
42"	30"	EW14230	\$475	\$523	\$570
48"	30"	EW14830	\$490	\$539	\$588
54"	30"	EW15430	\$570	\$627	\$684
60"	30"	EW16030	\$615	\$677	\$738
66"	30"	EW16630	\$655	\$721	\$786
72"	30"	EW17230	\$690	\$759	\$828
78"	30"	EW17830	\$710	\$781	\$852
84"	30"	EW18430	\$750	\$825	\$900
90"	30"	EW19030	\$790	\$869	\$948
96"	30"	EW19630	\$815	\$897	\$978
102"	30"	EW110230	\$900	\$990	\$1,080
108"	30"	EW110830	\$945	\$1,040	\$1,134
114"	30"	EW111430	\$980	\$1,078	\$1,176
120"	30"	EW112030	\$1,020	\$1,122	\$1,224

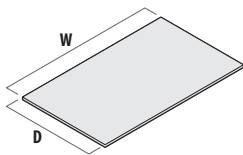

### 36" Deep

48"	36"	EW14836	\$680	\$748	\$816
54"	36"	EW15436	\$705	\$776	\$846
60"	36"	EW16036	\$735	\$809	\$882
66"	36"	EW16636	\$775	\$853	\$930
72"	36"	EW17236	\$830	\$913	\$996
78"	36"	EW17836	\$875	\$963	\$1,050
84"	36"	EW18436	\$900	\$990	\$1,080
90"	36"	EW19036	\$945	\$1,040	\$1,134
96"	36"	EW19636	\$1,000	\$1,100	\$1,200
102"	36"	EW110236	\$1,055	\$1,161	\$1,266
108"	36"	EW110836	\$1,115	\$1,227	\$1,338
114"	36"	EW111436	\$1,175	\$1,293	\$1,410
120"	36"	EW112036	\$1,225	\$1,348	\$1,470

#### Specify

1. Model #
2. Options
3. Laminate
4. Edge band

#### Grain Direction

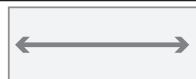

#### Wiring & Cabling



Grommet \$25



Scallop \$50

#### Support Information

All supports must be ordered separately. See page 84 – 85.

#### Worksurface Loading & Support

See page 73.

A center support must be used with a 54" wide or wider worksurface.

# Worksurfaces

## Corners

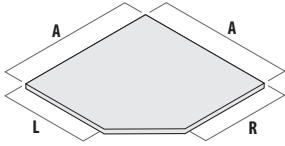

### Straight Front

				LAMINATE		
A	L	R	MODEL #	L1	L2	L3
36"	20"	20"	EW1C3620	\$565	\$622	\$678
36"	24"	24"	EW1C3624	\$565	\$622	\$678
36"	30"	30"	EW1C3630	\$635	\$699	\$762
42"	20"	20"	EW1C4220	\$715	\$787	\$858
42"	24"	24"	EW1C4224	\$715	\$787	\$858
42"	30"	30"	EW1C4230	\$775	\$853	\$930
48"	20"	20"	EW1C4820	\$855	\$941	\$1,026
48"	24"	24"	EW1C4824	\$855	\$941	\$1,026
48"	30"	30"	EW1C4830	\$870	\$957	\$1,044

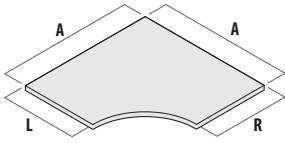

### Curved Front

A	L	R	MODEL #	L1	L2	L3
36"	24"	24"	EW1CC3624	\$620	\$682	\$744
42"	24"	24"	EW1CC4224	\$790	\$869	\$948
48"	24"	24"	EW1CC4824	\$940	\$1,034	\$1,128
60"	24"	24"	EW1CC6024	\$1,050	\$1,155	\$1,260

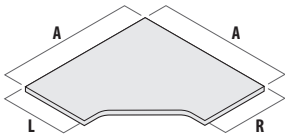

### Corner with Cutout

A	L	R	MODEL #	L1	L2	L3
48"	24"	24"	EW1C4824K	\$850	\$935	\$1,020

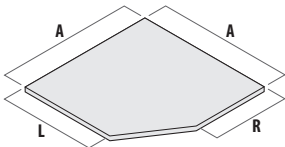

### Different Returns

A	L	R	MODEL #	L1	L2	L3
36"	24"	30"	EW1C362430	\$760	\$836	\$912
36"	30"	24"	EW1C363024	\$760	\$836	\$912
42"	24"	30"	EW1C422430	\$855	\$941	\$1,026
42"	30"	24"	EW1C423024	\$855	\$941	\$1,026
48"	24"	30"	EW1C482430	\$945	\$1,040	\$1,134
48"	30"	24"	EW1C483024	\$945	\$1,040	\$1,134

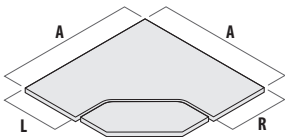

### Split Corner — all hardware included

				LAMINATE			PAINT (CANTILEVERS ONLY)	
A	L	R	MODEL #	L1	L2	L3	P2	P3
36"	24"	24"	EW1SC3624	\$1,885	\$2,074	\$2,262	+\$15	+\$30
42"	24"	24"	EW1SC4224	\$1,935	\$2,129	\$2,322	+\$15	+\$30
42"	30"	30"	EW1SC4230	\$1,965	\$2,162	\$2,358	+\$15	+\$30
48"	24"	24"	EW1SC4824	\$2,045	\$2,250	\$2,454	+\$15	+\$30
48"	30"	30"	EW1SC4830	\$2,180	\$2,398	\$2,616	+\$15	+\$30

Paint option is for cantilevers only. All other hardware is only available in black.

#### Specify

1. Model #
2. Options
3. Laminate
4. Edge band
5. Grain direction

#### Grain Direction

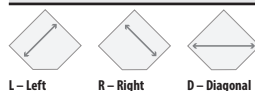

Insert the desired direction after the laminate finish code.

Add \$25 to list price for diagonal grain (D).

#### Wiring & Cabling

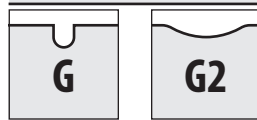

Grommet \$25

Scallop \$50

#### Application Notes

A return panel may not be used next to corner worksurfaces, as they cover both posts for a smooth transition with adjacent rectangular worksurfaces.

#### Support Information

All supports must be ordered separately. See page 84 – 85.

**Worksurface Loading & Support**  
See page 73.

A center support must be used with a 54" wide or wider worksurface.

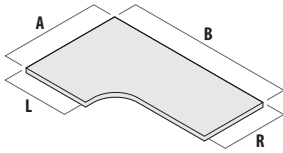

### Right Hand

L	A	B	R	MODEL #	LAMINATE		
					L1	L2	L3
24"	36"	60"	24"	EW1BS3660S(X/L/R/B)	\$845	\$930	\$1,014
24"	48"	60"	24"	EW1BS4860S(X/L/R/B)	\$865	\$952	\$1,038
24"	48"	66"	24"	EW1BS4866S(X/L/R/B)	\$890	\$979	\$1,068
24"	36"	72"	24"	EW1BS3672S(X/L/R/B)	\$890	\$979	\$1,068
24"	48"	72"	24"	EW1BS4872S(X/L/R/B)	\$930	\$1,023	\$1,116
24"	48"	60"	30"	EW1BS4860D(X/L/R/B)	\$890	\$979	\$1,068
24"	48"	66"	30"	EW1BS4866D(X/L/R/B)	\$910	\$1,001	\$1,092
24"	48"	72"	30"	EW1BS4872D(X/L/R/B)	\$965	\$1,062	\$1,158
30"	48"	60"	24"	EW1BD4860S(X/L/R/B)	\$890	\$979	\$1,068
30"	48"	66"	24"	EW1BD4866S(X/L/R/B)	\$895	\$985	\$1,074
30"	48"	72"	24"	EW1BD4872S(X/L/R/B)	\$940	\$1,034	\$1,128

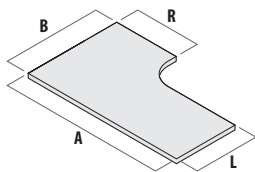

### Left Hand

24"	60"	36"	24"	EW1BS6036S(X/L/R/B)	\$845	\$930	\$1,014
24"	60"	48"	24"	EW1BS6048S(X/L/R/B)	\$870	\$957	\$1,044
24"	66"	48"	24"	EW1BS6648S(X/L/R/B)	\$890	\$979	\$1,068
24"	72"	36"	24"	EW1BS7236S(X/L/R/B)	\$895	\$985	\$1,074
24"	72"	48"	24"	EW1BS7248S(X/L/R/B)	\$930	\$1,023	\$1,116
24"	60"	48"	30"	EW1BS6048D(X/L/R/B)	\$870	\$957	\$1,044
24"	66"	48"	30"	EW1BS6648D(X/L/R/B)	\$890	\$979	\$1,068
24"	72"	48"	30"	EW1BS7248D(X/L/R/B)	\$940	\$1,034	\$1,128
30"	60"	48"	24"	EW1BD6048S(X/L/R/B)	\$870	\$957	\$1,044
30"	66"	48"	24"	EW1BD6648S(X/L/R/B)	\$910	\$1,001	\$1,092
30"	72"	48"	24"	EW1BD7248S(X/L/R/B)	\$965	\$1,062	\$1,158

							Options	
		L	A	B	R	Posts Covered	Wiring	
EW1B	Blended Worksurface	S 24" D 30"	36	72	S 24" D 30"	X No posts covered L Left side post covered R Right side post covered B Both side posts covered	G Grommet \$25 G2 Scallop \$50	
EW1B		S	36	72	S	X	G	

#### Specify

1. Model #
2. Options
3. Laminate
4. Edge band

#### Grain Direction



#### Wiring & Cabling

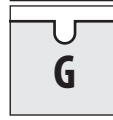

Grommet \$25



Scallop \$50

#### Application Notes

Blended worksurfaces are designed to take the place of two adjacent worksurfaces by blending them into one top. The front of the worksurface is curved to provide a smooth transition to the next attached worksurface.

#### Support Information

All supports must be ordered separately. See page 84.

#### Worksurface Loading & Support

A center support must be used with a 54" wide or wider worksurface.

# Worksurfaces

## Corner Peninsulas

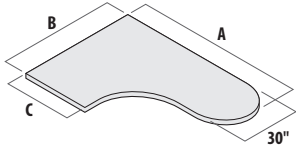

### Right Hand

A	B	C	MODEL #	LAMINATE		
				L1	L2	L3
60"	48"	24"	EW1BP6048SR	\$975	\$1,073	\$1,170
72"	48"	24"	EW1BP7248SR	\$995	\$1,095	\$1,194
72"	48"	30"	EW1BP7248DR	\$1,020	\$1,122	\$1,224
78"	48"	24"	EW1BP7848SR	\$1,040	\$1,144	\$1,248
78"	48"	30"	EW1BP7848DR	\$1,040	\$1,144	\$1,248
84"	48"	24"	EW1BP8448SR	\$1,225	\$1,348	\$1,470
84"	48"	30"	EW1BP8448DR	\$1,250	\$1,375	\$1,500

### Left Hand

60"	48"	24"	EW1BP6048SL	\$975	\$1,073	\$1,170
72"	48"	24"	EW1BP7248SL	\$995	\$1,095	\$1,194
72"	48"	30"	EW1BP7248DL	\$1,020	\$1,122	\$1,224
78"	48"	24"	EW1BP7848SL	\$1,040	\$1,144	\$1,248
78"	48"	30"	EW1BP7848DL	\$1,040	\$1,144	\$1,248
84"	48"	24"	EW1BP8448SL	\$1,225	\$1,348	\$1,470
84"	48"	30"	EW1BP8448DL	\$1,250	\$1,375	\$1,500

Worksurfaces

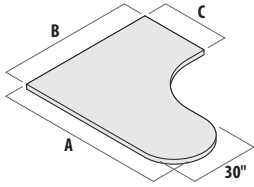

	A	B	C	Posts Covered
EW1BP Blended Peninsula	36	72	S 24" Deep D 30" Deep	L Left side post covered R Right side post covered
EW1BP	36	72	S	L

#### Specify

1. Model #
2. Options
3. Laminate
4. Edge band

#### Grain Direction

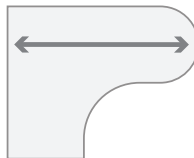

#### Grommet

Blended peninsulas do not come with a grommet. Due to this, if the work surface adjacent to the "C" side is ordered with scallops there will be a one-half scallop where the return meets the peninsula.

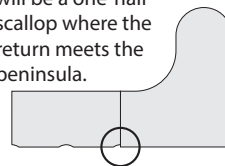

#### Support Information

All supports must be ordered separately. See page 84 – 85.

#### Worksurface Loading & Support

See page 73.  
Center support must be used for all surfaces which exceed 48" in length.

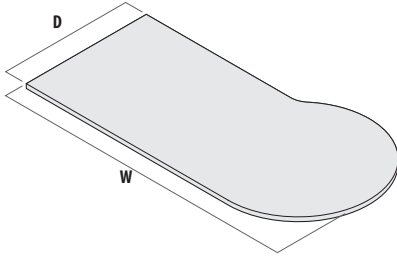
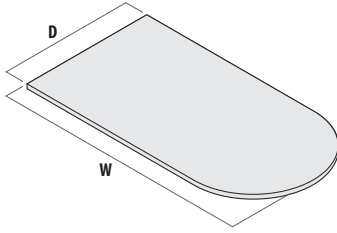

### D Peninsula

W	D	MODEL #	LAMINATE		
			L1	L2	L3
60"	30"	EW1D6030	\$550	\$605	\$660
72"	30"	EW1D7230	\$955	\$1,051	\$1,146
72"	36"	EW1D7236	\$1,115	\$1,227	\$1,338
84"	30"	EW1D8430	\$1,250	\$1,375	\$1,500
84"	36"	EW1D8436	\$1,390	\$1,529	\$1,668

### 9 & P Peninsula

72"	30"	EW1(9/P)7230	\$955	\$1,051	\$1,146
72"	36"	EW1(9/P)7236	\$1,115	\$1,227	\$1,338
84"	30"	EW1(9/P)8430	\$1,250	\$1,375	\$1,500
84"	36"	EW1(9/P)8436	\$1,390	\$1,529	\$1,668

	W	D
EW1D D Peninsula	72	30
EW19 9 Peninsula		
EW1P P Peninsula		
<b>EW1BP</b>	<b>72</b>	<b>30</b>

#### Specify

1. Model #
2. Options
3. Laminate
4. Edge band

#### Grain Direction

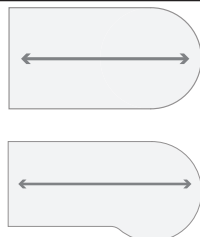

#### Application Notes

Designed for use as primary worksurfaces and for conferencing in small groups.

**NOTE: P and D worksurfaces cannot be panel wrapped.**

#### Support Information

Column bases and adjustable bar supports must be ordered separately. See page 84 – 85.

**Worksurface Loading & Support**  
See page 73.

84" wide D, P and 9 worksurfaces include a V support bar mounted on the underside for additional stability.

# Worksurfaces

## Half-Round & Linking

Worksurfaces

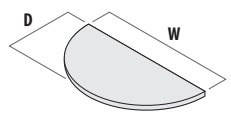

### Half Round without Notch

W	D	MODEL #	LAMINATE		
			L1	L2	L3
48"	30"	EW1HR4830	\$745	\$820	\$894
60"	36"	EW1HR6036	\$934	\$1,027	\$1,121

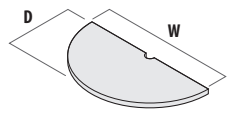

### Half Round with Notch

W	D	MODEL #	L1	L2	L3
48"	30"	EW1HR4830N	\$745	\$820	\$894
60"	36"	EW1HR6036N	\$934	\$1,027	\$1,121



### Corner Round

D	MODEL #	L1	L2	L3
24"	EW1CR24	\$335	\$369	\$402
30"	EW1CR30	\$365	\$402	\$438

				Options	
		W	D	Notch	
EW1HR	Half Round	36	72	N	Round Notch
EW1HR		36	72	N	

Specify	Grain Direction	Half Round Without Notches	Half Round With Notches	Support Information
<ol style="list-style-type: none"> <li>1. Model #</li> <li>2. Options</li> <li>3. Laminate</li> <li>4. Edge band</li> </ol>		<p>Half rounds without notches attach to panels by means of an adjustable bar support and are supported by column bases, available in standard trim colors. Column is fixed height.</p>	<p><b>Included</b></p> <ul style="list-style-type: none"> <li>• Splice plates</li> </ul> <p><b>Not Included nor Required</b></p> <ul style="list-style-type: none"> <li>• Bar support</li> </ul>	<p>All supports must be ordered separately. See page 84 – 85.</p> <p><b>Worksurface Loading &amp; Support</b> See page 73.</p>



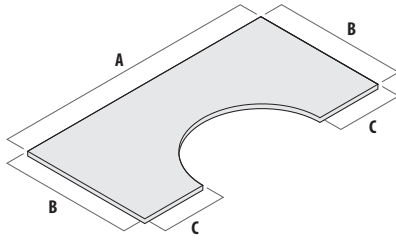

### Blended Double Corner

A	B	C	MODEL #	LAMINATE		
				L1	L2	L3
96"	48"	24"	EW1BC9648	\$1,250	\$1,375	\$1,500

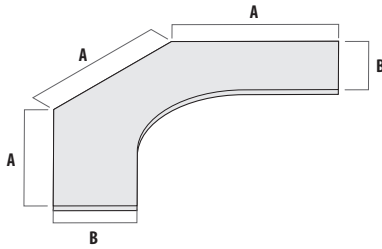

### 135° Curved Cluster

A	B	MODEL #	L1	L2	L3
36"	24"	EW11353624	\$917	\$1,009	\$1,100
42"	24"	EW11354224	\$1,145	\$1,260	\$1,374
48"	24"	EW11354824	\$1,317	\$1,449	\$1,580

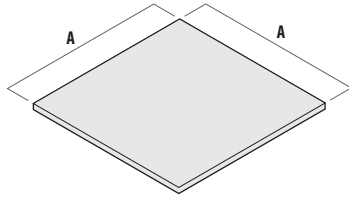

### 135° Cluster Core

A	MODEL #	L1	L2	L3
36"	EW1135C36	\$586	\$645	\$703
42"	EW1135C42	\$647	\$712	\$776
48"	EW1135C48	\$711	\$782	\$853

#### Specify

1. Model #
2. Options
3. Laminate
4. Edge band

#### Grain Direction

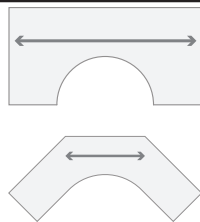

#### Double Corner

Double corner work surface is designed to take the place of two adjacent corners by combining them into one top.

48" deep sides are designed to cover a post and cannot be panel wrapped.

#### 135° Curved Cluster

Used in 135° planning configurations.

#### Support Information

All supports must be ordered separately. See page 84 – 85.

**Worksurface Loading & Support**  
See page 73.

#### Wiring & Cabling



Grommet \$25    Scallop \$50

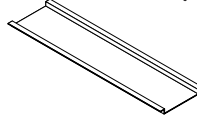
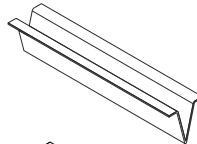
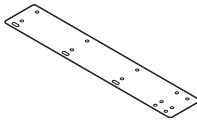
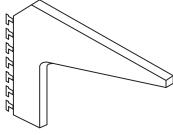

### Cantilever

DESCRIPTION	D	MODEL #	BLACK	PAINT		
				P1	P2	P3
Left hand	20"	<b>EB1C20L</b>	\$90	\$150	\$165	\$180
Left hand (10 pack)	20"	<b>EB1C20L10</b>	\$700	\$1,000	\$1,100	\$1,200
Right hand	20"	<b>EB1C20R</b>	\$90	\$150	\$165	\$180
Right hand (10 pack)	20"	<b>EB1C20R10</b>	\$700	\$1,000	\$1,100	\$1,200

### 120 Cantilever

Left hand 60°	18"	<b>EB3C18L60</b>	\$92	\$152	\$167	\$182
Left hand 90°	18"	<b>EB3C18L90</b>	\$92	\$152	\$167	\$182
Right hand 60°	18"	<b>EB3C18R60</b>	\$92	\$152	\$167	\$182
Right hand 90°	18"	<b>EB3C18R90</b>	\$92	\$152	\$167	\$182

### Splice Plate

20" Flat bracket (20" & 24" tops)		<b>EB1F24</b>	\$45	N/A	N/A	N/A
26" Flat bracket (30" & 36" tops)		<b>EB1F30</b>	\$52	N/A	N/A	N/A
Alignment plate		<b>EB1APW</b>	\$14	N/A	N/A	N/A

### Bracket

Panel to worksurface bracket		<b>EB1PWS(L/R)</b>	\$15	\$50	\$55	\$60
Panel to worksurface bracket (Pair – L/R)		<b>EB1PWSP</b>	\$29	\$90	\$99	\$108

### V Channel Support

54"		<b>VS54</b>	\$125	N/A	N/A	N/A
100"		<b>VS100</b>	\$240	N/A	N/A	N/A

### Worksurface Support Rail

46"	60"	<b>WSR46</b>	\$80	N/A	N/A	N/A
57"	72"	<b>WSR57</b>	\$95	N/A	N/A	N/A

#### Cantilevers

Worksurface cantilevers lock into panel slotted standards at 1" increments. Cantilevers are handed.

#### Panel to Worksurface Bracket

Can be specified in lieu of cantilever when worksurface is same depth as adjacent panel.

A single bracket can be specified behind a pedestal to secure adjacent panel to worksurface.

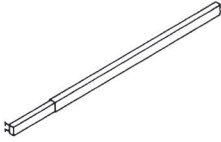

### Adjustable Bar Support

DESCRIPTION	MODEL #	BLACK	PAINT		
			P1	P2	P3
24", 30" and 36"	<b>EB1SRS</b>	\$200	\$250	\$275	\$300
24", 30" and 36" (10 pack)	<b>EB1SRS10</b>	\$1,900	\$2,400	\$2,640	\$2,880
42", 48" and 60"	<b>EB1SRL</b>	\$225	\$275	\$303	\$330
42", 48" and 60" (10 pack)	<b>EB1SRL10</b>	\$2,000	\$2,600	\$2,860	\$3,120

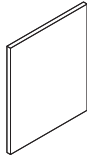

### Desk End Panels

H	W	MODEL #	LAMINATE		
			L1	L2	L3
29"	20"	<b>EB1DEP20</b>	\$613	\$674	\$736
29"	24"	<b>EB1DEP24</b>	\$625	\$688	\$750
29"	30"	<b>EB1DEP30</b>	\$661	\$727	\$793

#### Specify

1. Model #
2. Paint

#### Adjustable Bar Support

Adjustable bar supports position in the slotted standards at 1" increments. Two sizes of adjustable bar supports are available. Small adjustable bar support fits 24" through 36" wide panels; the larger adjustable bar support fits 42" through 60" wide panels. All have keyhole slots to mount worksurfaces and are non-handed.



### Column Bases

DESCRIPTION	H	MODEL #	PAINT		
			P1	P2	P3
Fixed height support column	27 ¾"	EB1FCOL	\$320	\$348	\$362



### Tapered Legs

Single leg	27 ¾"	TBTL	\$350	\$385	\$420
Single leg w/caster	27 ¾"	TBTLC	\$375	\$410	\$445
Set of 2	27 ¾"	TBTL2	\$600	\$660	\$720
Set of 2 w/casters	27 ¾"	TBTL2C	\$650	\$710	\$770
Set of 4	27 ¾"	TBTL4	\$1,150	\$1,265	\$1,380
Set of 4 w/casters	27 ¾"	TBTL4C	\$1,250	\$1,365	\$1,480
Bar height single leg	40 ½"	TBTLBH	\$790	\$890	\$990
Bar height set of 2	40 ½"	TBTLBH2	\$1,500	\$1,800	\$1,875
Bar height set of 4	40 ½"	TBTLBH4	\$2,700	\$3,000	\$3,400

#### Specify

1. Model #
2. Paint

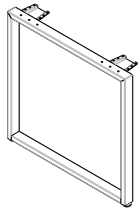

### O Legs

DESCRIPTION	H	MODEL #	PAINT		
			P1	P2	P3
24" Deep	27 3/4"	<b>TBOLL24</b>	\$597	\$657	\$716
30" Deep	27 3/4"	<b>TBOLL30</b>	\$607	\$668	\$728
24" Deep (set of 2)	27 3/4"	<b>TBOLL242</b>	\$1,177	\$1,295	\$1,412
30" Deep (set of 2)	27 3/4"	<b>TBOLL302</b>	\$1,197	\$1,317	\$1,436

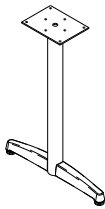

### T Legs

20" Deep	27 3/4"	<b>TBTLL20</b>	\$337	\$371	\$404
26" Deep	27 3/4"	<b>TBTLL26</b>	\$347	\$382	\$416
36" Deep	27 3/4"	<b>TBTLL36</b>	\$367	\$404	\$440
42" Deep	27 3/4"	<b>TBTLL42</b>	\$447	\$492	\$536
48" Deep	27 3/4"	<b>TBTLL48</b>	\$527	\$580	\$632
20" Deep (set of 2)	27 3/4"	<b>TBTLL202</b>	\$657	\$723	\$788
26" Deep (set of 2)	27 3/4"	<b>TBTLL262</b>	\$677	\$745	\$812
36" Deep (set of 2)	27 3/4"	<b>TBTLL362</b>	\$717	\$789	\$860
42" Deep (set of 2)	27 3/4"	<b>TBTLL422</b>	\$877	\$965	\$1,052
48" Deep (set of 2)	27 3/4"	<b>TBTLL482</b>	\$1,027	\$1,130	\$1,232

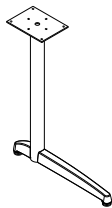

### C Legs

20" Deep	27 3/4"	<b>TBCLL20</b>	\$337	\$371	\$404
26" Deep	27 3/4"	<b>TBCLL26</b>	\$347	\$382	\$416
32" Deep	27 3/4"	<b>TBCLL32</b>	\$367	\$404	\$440
20" Deep (set of 2)	27 3/4"	<b>TBCLL202</b>	\$657	\$723	\$788
26" Deep (set of 2)	27 3/4"	<b>TBCLL262</b>	\$677	\$745	\$812
32" Deep (set of 2)	27 3/4"	<b>TBCLL322</b>	\$727	\$800	\$872

#### Specify

1. Model #
2. Paint

# Height Adjustable Worksurfaces

## Panel Supported

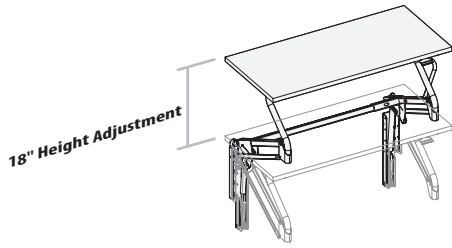

Worksurfaces

### Panel Supported Height Adjustable

W	D	MODEL #	LAMINATE		
			L1	L2	L3
42"	24"	EAW14224	\$2,047	\$2,137	\$2,177
48"	24"	EAW14824	\$2,137	\$2,179	\$2,221
54"	24"	EAW15424	\$2,237	\$2,252	\$2,287
60"	24"	EAW16024	\$2,252	\$2,303	\$2,353
72"	24"	EAW17224	\$2,352	\$2,409	\$2,465
42"	30"	EAW14230	\$2,147	\$2,220	\$2,267
48"	30"	EAW14830	\$2,207	\$2,256	\$2,305
54"	30"	EAW15430	\$2,317	\$2,374	\$2,431
60"	30"	EAW16030	\$2,362	\$2,424	\$2,485
72"	30"	EAW17230	\$2,477	\$2,546	\$2,615

### Panel Supported Height Adjustable – Mech Only

W	D	MODEL #	BLACK OR SILVER
42"	24"	EAW4224M	\$1,697
42"	30"	EAW4230M	\$1,697
48"	24"	EAW4824M	\$1,717
48"	30"	EAW4830M	\$1,717
54"	24"	EAW5424M	\$1,717
54"	30"	EAW5430M	\$1,717
60"	24"	EAW6024M	\$1,747
60"	30"	EAW6030M	\$1,747
72"	24"	EAW7224M	\$1,787
72"	30"	EAW7230M	\$1,787

Worksurface Type	W	D	Options		
			Wiring		
EAW1 Height Adjustable	42	24	G Grommet	\$25	
			G2 Scallop	\$50	
EAW1	42	24	G		

### Specify

1. Model #
2. Laminate
3. Edge band
4. Support color  
*Black or Silver*

### Grain Direction

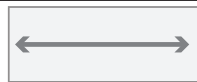

### Specification Guidelines

Order an adjustable height work surface to match the panel(s) width the worksurface will be attached to. The worksurface cannot be configured to cover a partial panel.

When used as a solitary work surface perpendicular panels of 18" minimum width must be specified on both sides for stability.

**NOTE: Adjustable work surface meets BIFMA loading requirements for safety. Mechanism is designed to have up to 100 lbs. of load and function smoothly.**

### Application Notes

Provides 18" of vertical movement.

### Wiring & Cabling

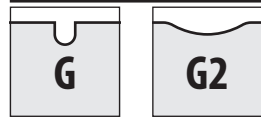

Grommet \$25    Scallop \$50

There will be a 1" space around the perimeter of the adjustable height worksurface in order to prevent pinch points.

When used in conjunction with a stationary worksurface there should be a perpendicular panel at the free end of the adjustable worksurface. The free end of the fixed worksurface should be supported with a cantilever or pedestal.

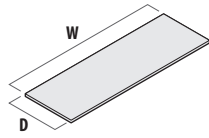

## Worksurface Only — For Height Adjustable Supports

W	D	MODEL #	LAMINATE		
			L1	L2	L3
42"	24"	EAW14224WS	\$400	\$440	\$480
42"	30"	EAW14230WS	\$475	\$523	\$570
48"	24"	EAW14824WS	\$420	\$462	\$504
48"	30"	EAW14830WS	\$490	\$539	\$588
54"	24"	EAW15424WS	\$460	\$506	\$552
54"	30"	EAW15430WS	\$550	\$605	\$659
60"	24"	EAW16024WS	\$505	\$556	\$606
60"	30"	EAW16030WS	\$615	\$677	\$738
72"	24"	EAW17224WS	\$565	\$622	\$678
72"	30"	EAW17230WS	\$690	\$759	\$828



## Electric Height Adjustable Base

DESCRIPTION	FOOT DEPTH	MODEL #	BLACK OR SILVER
2 legs	23 3/8"	TBAHL224	\$1,997
2 legs	29"	TBAHL230	\$1,997
3 legs	23 3/8"	TBAHL324	\$2,797

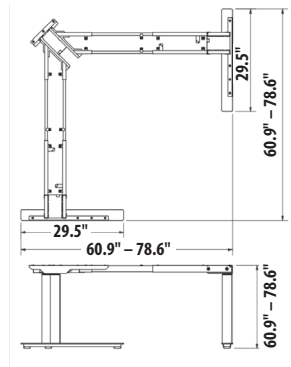
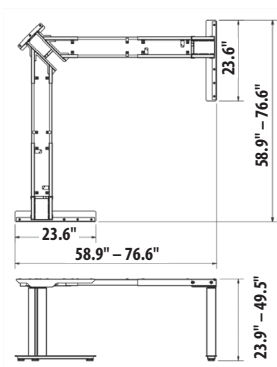
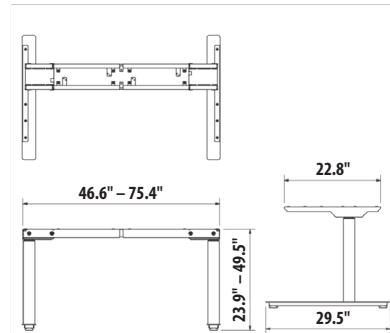
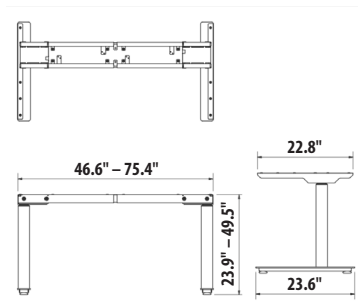
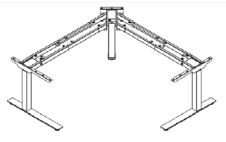

### Specify

1. Model #
2. Trim color

### Application Notes

#### Electric Height Adjustable Base

Adjustable height bases can be used with 24" & 30" deep worksurfaces. Worksurfaces must be between 48" – 84" wide.

Adjustable height bases have a capacity of 264 lbs evenly distributed.

Comes with four position memory controller.

Anti-collision stops and reverses the travel of the table when the table collides with a fixed object during operation.

3-stage legs offer a large height adjustment range of 24" – 50".

# Worksurfaces

## 120° Planning

These worksurfaces are designed specifically for Equity 120° applications. The (L/R) suffix at the end of a model number indicates a defined pedestal location. If the worksurface has no defined pedestal location, the (L/R) represents the curved side of the top. All tops and tables are available with 2mm edge band or a cascading edge.

### Worksurface: W3

This worksurface, combined with the T3 transition top, works best with the "apartment" layout. This application allows for stations on both sides of the spine, and is ideal for high density layouts. Available in extended versions for placement directly next to another worksurface.

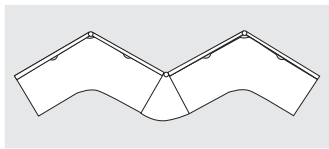

### Worksurface: W4

This top works well in the "open house," "full house," and "big house" layouts for call center, professional and managerial applications.

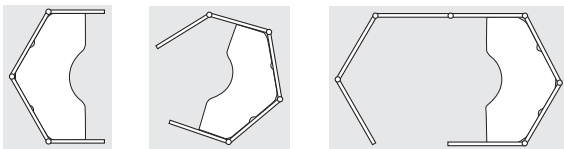

### Worksurface: W5 (L/R)

With transition top T5 and this worksurface, teaming is made easy using the "townhouse" or "open house" layout. The shared space allows for call center, professional or technical applications.

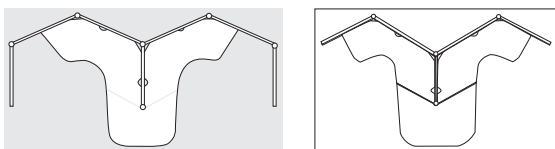

### Worksurface: W6 (L/R)

In the "big house," "full house" or "open house," this worksurface allows for a pedestal on one side (determined by the L/R).

Applications for this top include a call center with the "open house," technical applications with the "full house," and managerial layouts with the "big house."

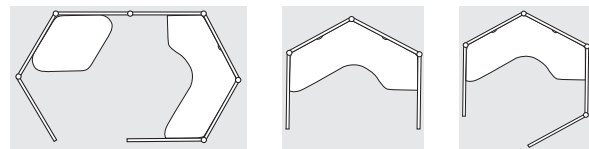

### Worksurface: W7 (L/R)

Used in conjunction with a T4 transition top, the W7 worksurface provides a great teaming space when the "townhouse" layout is used. The "open house" layout incorporates the T2 transition top for professional or technical stations with shared space for conferencing. Available in extended versions for placement directly next to another worksurface.

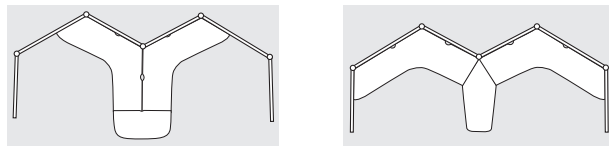

### Worksurface: W11 / W1118 (L/R)

This top is a spacious option for a technical station in the "open house" layout. Adding a T2 transition top provides additional teaming space. The W11 surface also fits nicely in a private managerial office or a "full house" professional application.

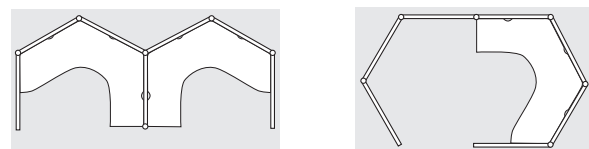



**Worksurface: W12 / W1218 (L/R)**

This top, with the T5/T518 transition top provides a technical office with shared conferencing space in the “open house” layout. The 18” return allows ample space in the supervisory application of the “full house.”

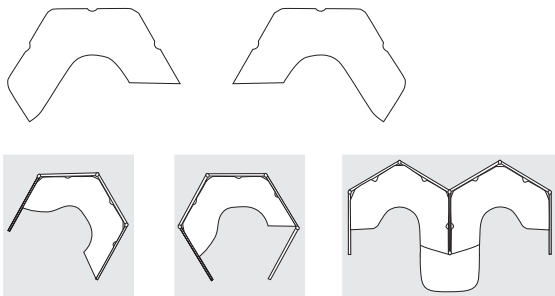

**Worksurface: W13 / W1318 (L/R)**

This surface provides a teaming space with the T2/T218 transition in the “open house” layout. The W13/W1318 creates generous worksurface space in the “full house” as well as the management layout of the “big house.”

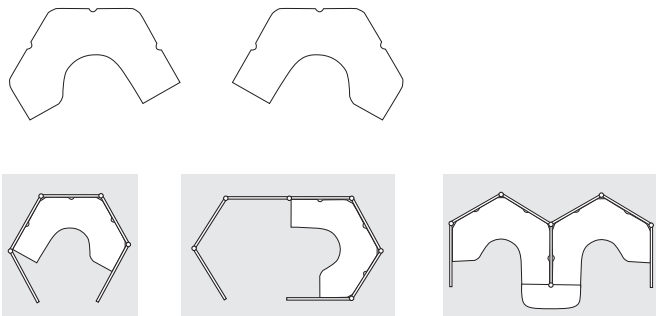

**Transition Tops**

Transition tops require columns (not included — (page 85)) for support. Flat brackets (not included — (page 84)) are required to attach transition tops to adjacent worksurfaces.



Transition top



Transition top



Transition top



Transition top

**Peninsula Tops**

Peninsula tops provide additional workspace in a “big house” layout.

Peninsula tops are freestanding and supported by table legs, columns or a combination of both (not included — (page 85)).

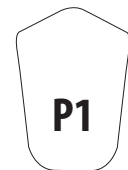

Peninsula top

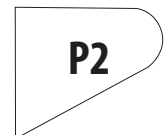

Peninsula top: P2 right hand

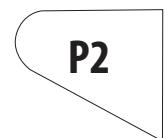

Peninsula top: P2 left hand

# Worksurfaces 120°

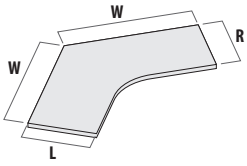

## W3

W	L	R	MODEL #	LAMINATE		
				L1	L2	L3
48"	24"	24"	EW1W34824	\$1,020	\$1,122	\$1,224

### Woodgrain Direction

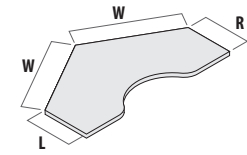
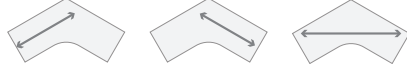

## W4

48"	24"	24"	EW1W44824	\$1,030	\$1,133	\$1,236
-----	-----	-----	-----------	---------	---------	---------

### Woodgrain Direction

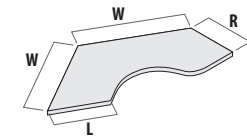

## W5

48"	24"	24"	EW1W54824L	\$975	\$1,073	\$1,170
48"	24"	24"	EW1W54824R	\$975	\$1,073	\$1,170

### Woodgrain Direction

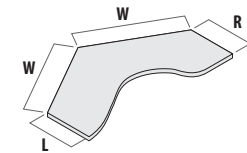
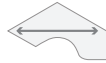

## W6

48"	24"	24"	EW1W64824L	\$1,090	\$1,199	\$1,308
48"	24"	24"	EW1W64824R	\$1,090	\$1,199	\$1,308

### Woodgrain Direction



### Specify

1. Model #
2. Laminate
3. Edge band

### Support Information

All supports must be ordered separately. See page 84 – 85.

### Worksurface Loading & Support

See page 73.

### Application Notes

Refer to the worksurface planning page (90) for worksurface drawings and applications.

### W3

W3 top may be extended on either the left or right hand side by adding an "EL" or "ER" to the end of the model number and adding \$21 (list).

W3 top may be extended on both ends by adding an "EB" to the end of the model number and adding \$42 (list).

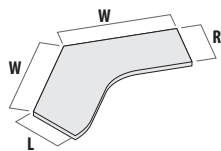

W7				LAMINATE		
W	L	R	MODEL #	L1	L2	L3
48"	24"	24"	EW1W74824L	\$1,085	\$1,194	\$1,302
48"	24"	24"	EW1W74824R	\$1,085	\$1,194	\$1,302

### Woodgrain Direction

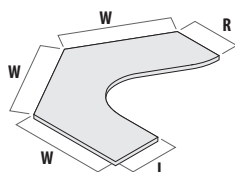

W11				LAMINATE		
W	L	R	MODEL #	L1	L2	L3
48"	24"	18"	EW1W11482418	\$1,280	\$1,408	\$1,536
48"	18"	24"	EW1W11481824	\$1,280	\$1,408	\$1,536

### Woodgrain Direction

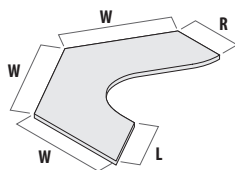

W12				LAMINATE		
W	L	R	MODEL #	L1	L2	L3
48"	24"	18"	EW1W12482418	\$1,360	\$1,496	\$1,632
48"	18"	24"	EW1W12481824	\$1,360	\$1,496	\$1,632
48"	24"	24"	EW1W124824L	\$1,360	\$1,496	\$1,632
48"	24"	24"	EW1W124824R	\$1,360	\$1,496	\$1,632

### Woodgrain Direction

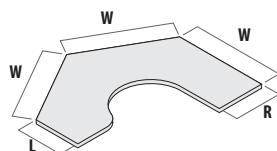

W13				LAMINATE		
W	L	R	MODEL #	L1	L2	L3
48"	24"	18"	EW1W13482418	\$1,310	\$1,441	\$1,572
48"	18"	24"	EW1W13481824	\$1,310	\$1,441	\$1,572
48"	24"	24"	EW1W134824L	\$1,310	\$1,441	\$1,572
48"	24"	24"	EW1W134824R	\$1,310	\$1,441	\$1,572

### Woodgrain Direction



Specify	Support Information	Application Notes	W7
<ol style="list-style-type: none"> <li>1. Model #</li> <li>2. Laminate</li> <li>3. Edge band</li> </ol>	<p>All supports must be ordered separately. See page 84 – 85.</p> <p><b>Worksurface Loading &amp; Support</b> See page 73.</p>	<p>Refer to the worksurface planning page (90) for worksurface drawings and applications.</p>	<p>Straight ends are available extended by adding an "E" to the end of the model number and adding \$21 (list).</p>

# Worksurfaces

## Transition Tops

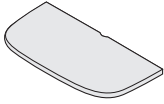

T2			LAMINATE		
W	RETURN	MODEL #	L1	L2	L3
50"	24"	EW1T224	\$655	\$721	\$786
37 1/2"	18"	EW1T218	\$615	\$677	\$738



T3			LAMINATE		
W	RETURN	MODEL #	L1	L2	L3
26"	24"	EW1T324	\$625	\$688	\$750

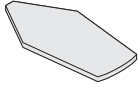

T4			LAMINATE		
W	RETURN	MODEL #	L1	L2	L3
26"	24"	EW1T424	\$645	\$710	\$774

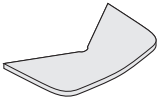

T5			LAMINATE		
W	RETURN	MODEL #	L1	L2	L3
37 1/2"	18"	EW1T518	\$675	\$743	\$810
50"	24"	EW1T524	\$660	\$726	\$792



Peninsula Tops			LAMINATE		
W	RETURN	MODEL #	L1	L2	L3
35"	52"	EW1P15235 (L/R)	\$725	\$798	\$870
36"	38"	EW1P23836(L/R)	\$700	\$770	\$840

Worksurfaces

Specify	Grain Direction	T2 Transition Top	Support Information
<ol style="list-style-type: none"> <li>1. Model #</li> <li>2. Laminate</li> <li>3. Edge band</li> </ol>		<p>T2 transition top comes cut to fit against a postless end. If placing against an end with a post, add an "N" to the end of the model number so it is notched for the post.</p>	<p>Transition and peninsula tops require a column base for support.</p> <p>All supports must be ordered separately. See page 84 – 85.</p> <p><b>Worksurface Loading &amp; Support</b> See page 73.</p>

---

## CASCADE EDGE

---



Cascade edge worksurfaces are wrapped with a thermafoil sheet that is heated and pressed around a substrate. This substrate can be FSC certified upon request. Thermafoil is more susceptible to denting, impact, tearing and marring than conventional high pressure laminate and should be handled with care. Do not drag worksurfaces across any flooring surface. Treat cascade edge worksurfaces like veneer worksurfaces for optimum performance under normal conditions. Cascade edge worksurfaces come with a 10 year warranty that covers defects in workmanship and materials. This warranty does not cover damage occurring during or after installation.

Cascade edge worksurfaces in solid colors utilize a non-PVC construction and are also free of any plasticizers, pthalates and lead content.

### AVAILABLE LAMINATES

#### Solid

---

114 Folkstone Grey  
117 Soft Grey  
118 Bright White  
119 Pumice

#### Woodgrain

---

124 Medium Cherry  
125 Natural Maple  
126 Natural Cherry  
127 Walnut

# Cascade Worksurfaces

## Straights

Worksurfaces

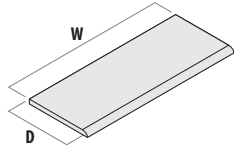

### 24" Deep

W	D	MODEL #	LAMINATE	
			SOLID	WOODGRAIN
24"	24"	ECE1R2424N	\$222	\$255
30"	24"	ECE1R3024N	\$255	\$293
36"	24"	ECE1R3624N	\$281	\$324
42"	24"	ECE1R4224N	\$324	\$373
48"	24"	ECE1R4824N	\$364	\$419
54"	24"	ECE1R5424N	\$391	\$449
60"	24"	ECE1R6024N	\$424	\$488
66"	24"	ECE1R6624N	\$459	\$526
72"	24"	ECE1R7224N	\$479	\$551
78"	24"	ECE1R7824N	\$515	\$591
84"	24"	ECE1R8424N	\$544	\$625
90"	24"	ECE1R9024N	\$614	\$704
96"	24"	ECE1R9624N	\$670	\$770

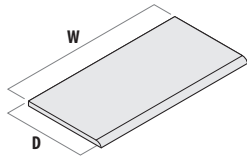

### 30" Deep

24"	30"	ECE1R2430N	\$282	\$326
30"	30"	ECE1R3030N	\$317	\$364
36"	30"	ECE1R3630N	\$353	\$406
42"	30"	ECE1R4230N	\$383	\$439
48"	30"	ECE1R4830N	\$424	\$488
54"	30"	ECE1R5430N	\$480	\$552
60"	30"	ECE1R6030N	\$528	\$606
66"	30"	ECE1R6630N	\$589	\$677
72"	30"	ECE1R7230N	\$614	\$704
78"	30"	ECE1R7830N	\$654	\$752
84"	30"	ECE1R8430N	\$696	\$800
90"	30"	ECE1R9030N	\$748	\$860
96"	30"	ECE1R9630N	\$800	\$919

### Sample

12"	12"	ECE1R1212G2	\$137	\$159
-----	-----	-------------	-------	-------

#### Specify

1. Model #
2. Options
3. Laminate

#### Extended Ends

E . . . Covers 1 post	\$21
EE . . Covers 2 posts	\$42

#### Grain Direction

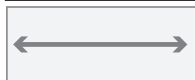

#### Edge Profile

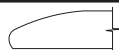

#### Wiring & Cabling



Scallop \$50

#### Available Laminates

**Solid**  
 114 Folkstone Grey  
 117 Soft Grey  
 118 Bright White  
 119 Pumice

**Woodgrain**  
 124 Medium Cherry  
 125 Natural Maple  
 126 Natural Cherry  
 127 Walnut

#### Support Information

All supports must be ordered separately. See page 84 – 85.

#### Worksurface Loading & Support

A center support must be used with a 54" wide or larger worksurface.

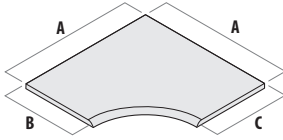

**Corner – Curved Front**

A	B	C	MODEL #	LAMINATE	
				SOLID	WOODGRAIN
36"	24"	24"	ECE1L3636SSN	\$554	\$639
42"	24"	24"	ECE1L4242SSN	\$670	\$770
42"	24"	30"	ECE1L4242SDN	\$796	\$913
42"	30"	24"	ECE1L4242DSN	\$796	\$913
48"	24"	24"	ECE1L4848SSN	\$752	\$865
48"	24"	30"	ECE1L4848SDN	\$901	\$1,036
48"	30"	24"	ECE1L4848DSN	\$901	\$1,036
48"	30"	30"	ECE1L4848DDN	\$808	\$930

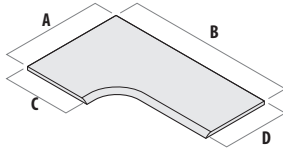

**Right Hand**

42"	60"	24"	24"	ECE1L4260SS( )N	\$919	\$1,058
42"	66"	24"	24"	ECE1L4266SS( )N	\$943	\$1,086
42"	72"	24"	24"	ECE1L4272SS( )N	\$979	\$1,127
42"	78"	24"	24"	ECE1L4278SS( )N	\$991	\$1,138
48"	60"	24"	24"	ECE1L4860SS( )N	\$932	\$1,070
48"	60"	24"	30"	ECE1L4860SD( )N	\$913	\$1,052
48"	60"	30"	24"	ECE1L4860DS( )N	\$913	\$1,052
48"	66"	24"	24"	ECE1L4866SS( )N	\$965	\$1,109
48"	66"	24"	30"	ECE1L4866SD( )N	\$961	\$1,106
48"	66"	30"	24"	ECE1L4866DS( )N	\$961	\$1,106
48"	72"	24"	24"	ECE1L4872SS( )N	\$1,000	\$1,150
48"	72"	24"	30"	ECE1L4872SD( )N	\$1,006	\$1,158
48"	72"	30"	24"	ECE1L4872DS( )N	\$1,006	\$1,158
48"	78"	24"	24"	ECE1L4878SS( )N	\$1,102	\$1,268
48"	84"	24"	24"	ECE1L4884SS( )N	\$1,239	\$1,426

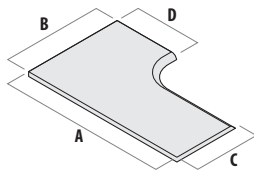

**Left Hand**

60"	42"	24"	24"	ECE1L6042SS( )N	\$919	\$1,058
60"	48"	24"	24"	ECE1L6048SS( )N	\$932	\$1,070
60"	48"	24"	30"	ECE1L6048SD( )N	\$913	\$1,052
60"	48"	30"	24"	ECE1L6048DS( )N	\$913	\$1,052
66"	42"	24"	24"	ECE1L6642SS( )N	\$943	\$1,086
66"	48"	24"	24"	ECE1L6648SS( )N	\$965	\$1,109
66"	48"	24"	30"	ECE1L6648SD( )N	\$961	\$1,106
66"	48"	30"	24"	ECE1L6648DS( )N	\$961	\$1,106
72"	42"	24"	24"	ECE1L7242SS( )N	\$979	\$1,127
72"	48"	24"	24"	ECE1L7248SS( )N	\$1,000	\$1,150
72"	48"	24"	30"	ECE1L7248SD( )N	\$1,006	\$1,158
72"	48"	30"	24"	ECE1L7248DS( )N	\$1,006	\$1,158
78"	42"	24"	24"	ECE1L7842SS( )N	\$991	\$1,138
78"	48"	24"	24"	ECE1L7848SS( )N	\$1,102	\$1,268
84"	48"	24"	24"	ECE1L8448SS( )N	\$1,239	\$1,426

**Application Notes**

**Center-Located Edge Grommet**

To specify, replace the "N" suffix from the model number with "G". Add \$42.

Equity "L" worksurfaces are handed and may or may not cover a post on either or both sides. Hand is determined from the seated position. Option suffixes for Equity blended corners are as follows:

- X . . . No posts covered
- L . . . Left post covered
- R . . . Right post covered
- B . . . Both posts covered

# Cascade Worksurfaces

## Corner Peninsulas

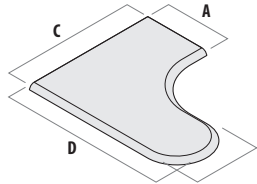
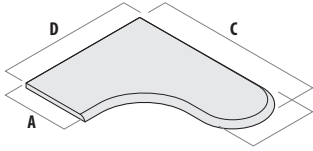

### Right Hand

A	C	D	MODEL #	LAMINATE	
				SOLID	WOODGRAIN
24"	66"	48"	ECE1BD6648SR	\$898	\$1,032
30"	66"	48"	ECE1BD6648DR	\$943	\$1,086
24"	72"	48"	ECE1BD7248SR	\$917	\$1,057
30"	72"	48"	ECE1BD7248DR	\$978	\$1,125
24"	78"	48"	ECE1BD7848SR	\$1,060	\$1,219
30"	78"	48"	ECE1BD7848DR	\$1,096	\$1,259
24"	84"	48"	ECE1BD8448SR	\$1,089	\$1,252
30"	84"	48"	ECE1BD8448DR	\$1,158	\$1,330

### Left Hand

A	C	D	MODEL #	LAMINATE	
				SOLID	WOODGRAIN
24"	48"	66"	ECE1BD6648SL	\$898	\$1,032
30"	48"	66"	ECE1BD6648DL	\$943	\$1,086
24"	48"	72"	ECE1BD7248SL	\$917	\$1,057
30"	48"	72"	ECE1BD7248DL	\$978	\$1,125
24"	48"	78"	ECE1BD7848SL	\$1,060	\$1,219
30"	48"	78"	ECE1BD7848DL	\$1,096	\$1,259
24"	48"	84"	ECE1BD8448SL	\$1,089	\$1,252
30"	48"	84"	ECE1BD8448DL	\$1,158	\$1,330

Worksurfaces

<b>Specify</b> 1. Model # 2. Options 3. Laminate	<b>Grain Direction</b> 	<b>Wiring &amp; Cabling</b> 	<b>Available Laminates</b> <b>Solid</b> 114 Folkstone Grey 117 Soft Grey 118 Bright White 119 Pumice <b>Woodgrain</b> 124 Medium Cherry 125 Natural Maple 126 Natural Cherry 127 Walnut	<b>Support Information</b> All supports must be ordered separately. See page 84 – 85. <b>Worksurface Loading &amp; Support</b> See page 73.
<b>Edge Profile</b> 				



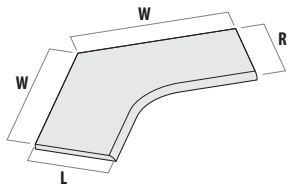
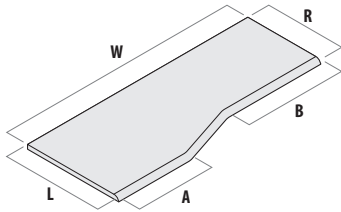
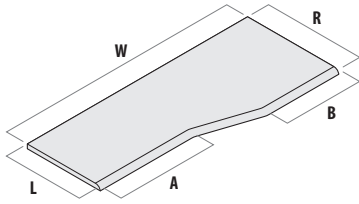

## Right Hand

W	L	R	A	B	MODEL #	LAMINATE	
						SOLID	WOODGRAIN
36"	24"	30"	3"	15"	ECE1W362430N	\$596	\$685
42"	24"	30"	9"	15"	ECE1W422430N	\$626	\$721
48"	24"	30"	15"	15"	ECE1W482430N	\$671	\$772
72"	24"	30"	30 1/2"	23 1/2"	ECE1W722430N	\$854	\$980

## Left Hand

W	L	R	A	B	MODEL #	SOLID	WOODGRAIN
36"	30"	24"	15"	1 1/2"	ECE1W363024N	\$596	\$685
42"	30"	24"	15"	7 1/2"	ECE1W423024N	\$626	\$721
48"	30"	24"	15"	15"	ECE1W483024N	\$671	\$772
72"	30"	24"	23 1/2"	30 1/2"	ECE1W723024N	\$854	\$980

## 120° Worksurface

W	L	R	A	B	MODEL #	SOLID	WOODGRAIN
48"	48"	24"	24"		ECE1W34824G	\$979	\$1,127

Worksurfaces

### Specify

1. Model #
2. Options
3. Laminate

### Grain Direction



### Edge Profile



### Wiring & Cabling



Scalloped \$50

### Available Laminates

- Solid**
- 114 Folkstone Grey
  - 117 Soft Grey
  - 118 Bright White
  - 119 Pumice

- Woodgrain**
- 124 Medium Cherry
  - 125 Natural Maple
  - 126 Natural Cherry
  - 127 Walnut

### Support Information

All supports must be ordered separately. See page 84 – 85.

**Worksurface Loading & Support**  
See page 73.

# Cascade Worksurfaces

## Rounds



### Half Round

W	D	MODEL #	LAMINATE	
			SOLID	WOODGRAIN
18"	48"	ECE1H4818P	\$479	\$551
48"	18"	ECE1H4818PC	\$479	\$551
48"	18"	ECE1H4818PE	\$479	\$551
60"	24"	ECE1H6024P	\$659	\$760
60"	24"	ECE1H6024PC	\$659	\$760
60"	24"	ECE1H6024PE	\$659	\$760



### Corner Round

24"	24"	ECE1CR24L/R	\$255	\$293
-----	-----	-------------	-------	-------



### Corner Round w/Notch

24"	24"	ECE1CR24N	\$255	\$293
-----	-----	-----------	-------	-------

#### Specify

1. Model #
2. Options
3. Laminate

#### Half Round

- P** Notched for post
- PE** Notched for postless end
- PC** Notched for post with cover

#### Grain Direction

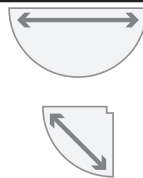

#### Edge Profile

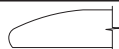

#### Available Laminates

- Solid**
- 114 Folkstone Grey
  - 117 Soft Grey
  - 118 Bright White
  - 119 Pumice

- Woodgrain**
- 124 Medium Cherry
  - 125 Natural Maple
  - 126 Natural Cherry
  - 127 Walnut

#### Support Information

All supports must be ordered separately. See page 84 – 85.

#### Worksurface Loading & Support

See page 73.



### Cable Sleeve w/Cover

H	D	MODEL #	BLACK ONLY
1 3/8"	3 1/4"	EW1CS	\$28



### Edge Grommet

H	W	D	MODEL #	BLACK ONLY
1 3/8"	2 1/4"	1 3/8"	EW1WSG	\$28

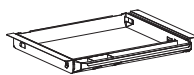

### Personal Drawer

DESCRIPTION	MODEL #	BLACK ONLY
Personal Drawer	SPD18	\$350

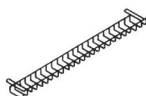

### Worksurface Cable Basket

H	W	D	MODEL #	BLACK	PAINT		
					P1	P2	P3
2"	20"	4"	EW1CB20	\$55	\$100	\$110	\$120
2"	32"	4"	EW1CB32	\$76	\$125	\$138	\$150
2"	42"	4"	EW1CB42	\$82	\$150	\$165	\$180

Worksurfaces

#### Cable Sleeve with Cover

Used to pass cables through a worksurface. Fits 3" diameter hole, field cut, in worksurface. Smooth plastic prevents abrasion of cords and cables.

Cover snaps into sleeve. Cover has slots that allow passage of one or two cables, yet gives appearance of surface continuity.

**Available in black only.**

#### Edge Grommet

Designed to accommodate various styles and quantities of cords/plugs between rear of worksurface and panel for improved cord/plug management. Designed to work with Equity EW1 tops shipped after 2005.

**Available in black only.**

#### Worksurface Cable Basket

Attaches to the underside of worksurface for excess cable management. Slides forward from its position adjacent to the panel face to allow passage of plugs. Constructed of steel wire.

# Counter Caps Straights

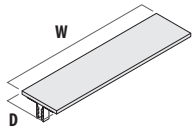

## Straight

W (NOMINAL)	W (ACTUAL)	D	MODEL #	LAMINATE			PAINT		
				L1	L2	L3	P2	P3	
12"	10 1/2"	15 1/4"	EW(3/N)1215	\$320	\$352	\$384	+ \$25	+ \$50	
24"	22 1/2"	15 1/4"	EW(3/N)2415	\$340	\$374	\$408	+ \$25	+ \$50	
30"	28 1/2"	15 1/4"	EW(3/N)3015	\$345	\$380	\$414	+ \$25	+ \$50	
36"	34 1/2"	15 1/4"	EW(3/N)3615	\$350	\$385	\$420	+ \$25	+ \$50	
42"	40 1/2"	15 1/4"	EW(3/N)4215	\$365	\$402	\$438	+ \$25	+ \$50	
48"	46 1/2"	15 1/4"	EW(3/N)4815	\$390	\$429	\$468	+ \$25	+ \$50	
60"	58 1/2"	15 1/4"	EW(3/N)6015	\$425	\$468	\$510	+ \$25	+ \$50	
72"	70 1/2"	15 1/4"	EW(3/N)7215	\$480	\$528	\$576	+ \$25	+ \$50	
84"	82 1/2"	15 1/4"	EW(3/N)8415	\$530	\$583	\$636	+ \$25	+ \$50	
96"	94 1/2"	15 1/4"	EW(3/N)9615	\$570	\$627	\$684	+ \$25	+ \$50	
108"	106 1/2"	15 1/4"	EW(3/N)10815	\$620	\$682	\$744	+ \$25	+ \$50	
120"	118 1/2"	15 1/4"	EW(3/N)12015	\$675	\$743	\$810	+ \$25	+ \$50	

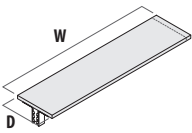

## Extended One End

12"	12"	15 1/4"	EW(3/N)1215E	\$330	\$363	\$396	+ \$25	+ \$50
24"	24"	15 1/4"	EW(3/N)2415E	\$350	\$385	\$420	+ \$25	+ \$50
30"	30"	15 1/4"	EW(3/N)3015E	\$355	\$391	\$426	+ \$25	+ \$50
36"	36"	15 1/4"	EW(3/N)3615E	\$360	\$396	\$432	+ \$25	+ \$50
42"	42"	15 1/4"	EW(3/N)4215E	\$375	\$413	\$450	+ \$25	+ \$50
48"	48"	15 1/4"	EW(3/N)4815E	\$400	\$440	\$480	+ \$25	+ \$50
60"	60"	15 1/4"	EW(3/N)6015E	\$435	\$479	\$522	+ \$25	+ \$50
72"	72"	15 1/4"	EW(3/N)7215E	\$490	\$539	\$588	+ \$25	+ \$50
84"	84"	15 1/4"	EW(3/N)8415E	\$540	\$594	\$648	+ \$25	+ \$50
96"	96"	15 1/4"	EW(3/N)9615E	\$580	\$638	\$696	+ \$25	+ \$50
108"	108"	15 1/4"	EW(3/N)10815E	\$630	\$693	\$756	+ \$25	+ \$50

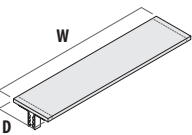

## Extended Both End

12"	13 1/2"	15 1/4"	EW(3/N)1215EE	\$340	\$374	\$408	+ \$25	+ \$50
24"	25 1/2"	15 1/4"	EW(3/N)2415EE	\$360	\$396	\$432	+ \$25	+ \$50
30"	31 1/2"	15 1/4"	EW(3/N)3015EE	\$365	\$402	\$438	+ \$25	+ \$50
36"	37 1/2"	15 1/4"	EW(3/N)3615EE	\$370	\$407	\$444	+ \$25	+ \$50
42"	43 1/2"	15 1/4"	EW(3/N)4215EE	\$385	\$424	\$462	+ \$25	+ \$50
48"	49 1/2"	15 1/4"	EW(3/N)4815EE	\$410	\$451	\$492	+ \$25	+ \$50
60"	61 1/2"	15 1/4"	EW(3/N)6015EE	\$445	\$490	\$534	+ \$25	+ \$50
72"	73 1/2"	15 1/4"	EW(3/N)7215EE	\$500	\$550	\$600	+ \$25	+ \$50
84"	85 1/2"	15 1/4"	EW(3/N)8415EE	\$550	\$605	\$660	+ \$25	+ \$50
96"	97 1/2"	15 1/4"	EW(3/N)9615EE	\$590	\$649	\$708	+ \$25	+ \$50
108"	109 1/2"	15 1/4"	EW(3/N)10815EE	\$640	\$704	\$768	+ \$25	+ \$50

### Specify

1. Model #
2. Options
3. Laminate
4. Edge band
5. Cantilever color

### Extended Ends

- E** . . . Covers 1 post  
**EE** . . . Covers 2 posts

### Application Notes

Counter caps are designed for mounting on top of panels.

Counter caps fit between posts, appropriate to fit between two taller panels and a dual/triple height connectors.

### Support Information

Steel cantilevers are supplied.

### Top Cap Compatibility

3 – Beveled

N – Flat

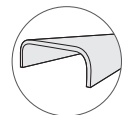
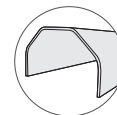

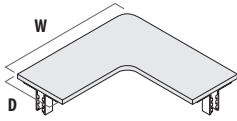

## Corner

W	D	MODEL #	LAMINATE			PAINT	
			L1	L2	L3	P2	P3
24"	15 1/4"	EW(3/N)CC2415	\$420	\$462	\$504	+ \$25	+ \$50
30"	15 1/4"	EW(3/N)CC3015	\$435	\$479	\$522	+ \$25	+ \$50
36"	15 1/4"	EW(3/N)CC3615	\$450	\$495	\$540	+ \$25	+ \$50

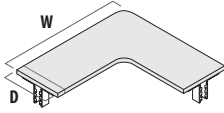

## Extended Left

24"	15 1/4"	EW(3/N)CC2415LHE	\$430	\$473	\$516	+ \$25	+ \$50
30"	15 1/4"	EW(3/N)CC3015LHE	\$445	\$490	\$534	+ \$25	+ \$50
36"	15 1/4"	EW(3/N)CC3615LHE	\$460	\$506	\$552	+ \$25	+ \$50

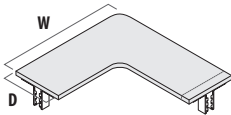

## Extended Right

24"	15 1/4"	EW(3/N)CC2415RHE	\$430	\$473	\$516	+ \$25	+ \$50
30"	15 1/4"	EW(3/N)CC3015RHE	\$445	\$490	\$534	+ \$25	+ \$50
36"	15 1/4"	EW(3/N)CC3615RHE	\$460	\$506	\$552	+ \$25	+ \$50

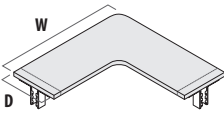

## Extended Both

24"	15 1/4"	EW(3/N)CC2415EE	\$440	\$484	\$528	+ \$25	+ \$50
30"	15 1/4"	EW(3/N)CC3015EE	\$455	\$501	\$546	+ \$25	+ \$50
36"	15 1/4"	EW(3/N)CC3615EE	\$470	\$517	\$564	+ \$25	+ \$50

### Specify

1. Model #
2. Options
3. Laminate
4. Edge band
5. Cantilever color

### Extended Ends

- E** . . . Covers 1 post  
**EE** . . . Covers 2 posts

### Application Notes

Counter caps are designed for mounting on top of panels.

Counter caps fit between posts, appropriate to fit between two taller panels and a dual/triple height connectors.

### Support Information

Steel cantilevers are supplied.

### Top Cap Compatibility

3 – Beveled

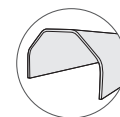

N – Flat



# Open Shelves

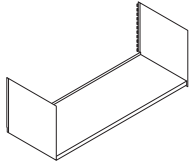

## Full Height

W	D	H	MODEL #	PAINT		
				P1	P2	P3
24"	12 3/8"	10 1/4"	ES2OS24	\$232	\$247	\$257
30"	12 3/8"	10 1/4"	ES2OS30	\$254	\$269	\$279
36"	12 3/8"	10 1/4"	ES2OS36	\$254	\$269	\$279
42"	12 3/8"	10 1/4"	ES2OS42	\$266	\$281	\$291
48"	12 3/8"	10 1/4"	ES2OS48	\$278	\$293	\$303
60"	12 3/8"	10 1/4"	ES2OS60	\$298	\$313	\$323
72"	12 3/8"	10 1/4"	ES2OS72	\$322	\$337	\$347

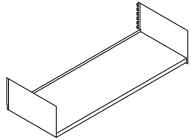

## Half Height

24"	12 3/8"	7 1/4"	ES3OS24	\$280	\$295	\$305
30"	12 3/8"	7 1/4"	ES3OS30	\$310	\$325	\$335
36"	12 3/8"	7 1/4"	ES3OS36	\$310	\$325	\$335
42"	12 3/8"	7 1/4"	ES3OS42	\$322	\$337	\$347
48"	12 3/8"	7 1/4"	ES3OS48	\$339	\$354	\$364
60"	12 3/8"	7 1/4"	ES3OS60	\$364	\$379	\$389
72"	12 3/8"	7 1/4"	ES3OS72	\$392	\$407	\$417

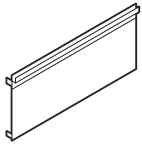

## Shelf Back

24"			EC2SB24	\$191	\$201	\$207
30"			EC2SB30	\$210	\$220	\$230
36"			EC2SB36	\$210	\$220	\$230
42"			EC2SB42	\$220	\$230	\$237
48"			EC2SB48	\$230	\$237	\$244
60"			EC2SB60	\$259	\$269	\$277
72"			EC2SB72	\$295	\$304	\$313



## Shelf – Divider

				BLACK ONLY		
2"	9"	6"	EC2SD	\$133	N/A	N/A

Panel Supported

### Specify

1. Model #
2. Paint

### Application Notes

Open shelf consists of two steel end panels and one steel shelf.

**NOTE: Cannot be converted to an enclosed cabinet.**

### Shelf Divider

Available in black only.

### Shelf Type

ES2OS Open Shelf  
ES3OS Open Shelf – Half Height

### W

36

ES2OS

36

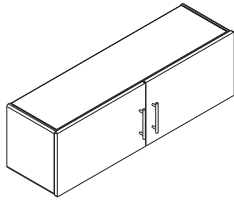

## Laminate Front — Side Hinge Door

W	D	H	# DOORS	MODEL #	LAMINATE			PAINT	
					L1	L2	L3	P2	P3
24"	12 1/2"	14 1/4"	2	EC2OL24	\$677	\$745	\$812	+ \$25	+ \$50
30"	12 1/2"	14 1/4"	2	EC2OL30	\$727	\$800	\$872	+ \$25	+ \$50
36"	12 1/2"	14 1/4"	2	EC2OL36	\$777	\$855	\$932	+ \$25	+ \$50
42"	12 1/2"	14 1/4"	2	EC2OL42	\$827	\$910	\$992	+ \$25	+ \$50
48"	12 1/2"	14 1/4"	2	EC2OL48	\$877	\$965	\$1,052	+ \$25	+ \$50
60"	12 1/2"	14 1/4"	4	EC2OL60	\$1,227	\$1,350	\$1,472	+ \$25	+ \$50
72"	12 1/2"	14 1/4"	4	EC2OL72	\$1,327	\$1,460	\$1,592	+ \$25	+ \$50

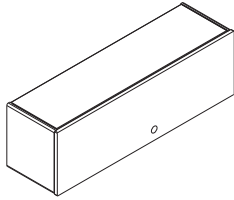

## Painted Steel — Flipper Door

W	D	H	# DOORS	MODEL #	PAINT		
					P1	P2	P3
24"	12 1/2"	14 1/4"	1	EC2OP24	\$602	\$627	\$652
30"	12 1/2"	14 1/4"	1	EC2OP30	\$681	\$706	\$731
36"	12 1/2"	14 1/4"	1	EC2OP36	\$681	\$706	\$731
42"	12 1/2"	14 1/4"	1	EC2OP42	\$759	\$784	\$809
48"	12 1/2"	14 1/4"	1	EC2OP48	\$801	\$826	\$851
60"	12 1/2"	14 1/4"	1	EC2OP60	\$913	\$938	\$963
72"	12 1/2"	14 1/4"	1	EC2OP72	\$1,004	\$1,029	\$1,054
72"	12 1/2"	14 1/4"	2	EC2OP272	\$1,219	\$1,244	\$1,269

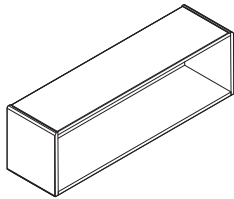

## Open

W	D	H	MODEL #			
24"	12 1/2"	14 1/4"	EC2OO24	\$457	\$503	\$548
30"	12 1/2"	14 1/4"	EC2OO30	\$557	\$613	\$668
36"	12 1/2"	14 1/4"	EC2OO36	\$577	\$635	\$692
42"	12 1/2"	14 1/4"	EC2OO42	\$607	\$668	\$728
48"	12 1/2"	14 1/4"	EC2OO48	\$707	\$778	\$848
60"	12 1/2"	14 1/4"	EC2OO60	\$807	\$888	\$968
72"	12 1/2"	14 1/4"	EC2OO72	\$907	\$998	\$1,088

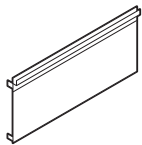

## Overhead Back

W	D	H	MODEL #			
24"	5/8"	14"	EC2CB24	\$191	\$201	\$207
30"	5/8"	14"	EC2CB30	\$210	\$220	\$230
36"	5/8"	14"	EC2CB36	\$210	\$220	\$230
42"	5/8"	14"	EC2CB42	\$220	\$230	\$237
48"	5/8"	14"	EC2CB48	\$230	\$237	\$244
60"	5/8"	14"	EC2CB60	\$259	\$269	\$277
72"	5/8"	14"	EC2CB72	\$295	\$304	\$313

### Specify

1. Model #
2. Paint
3. Optional Laminate

### Overhead – Side Hinge

Includes matching ABS edge band.

### Overhead – Flipper Door

Door uses heavy-duty ball bearing hinges to allow door to flip forward and up and over top of cabinet. Can be opened at an angle. Door rolls on glides for smooth, friction-free operation.

Overhead Type		W
EC2OL	Side Hinge	36
EC2OP	Flipper Door	
EC2OO	Open	
ES2OL		36

# Shared Storage

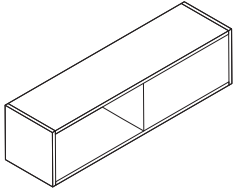

## 12" H

W	D	H	MODEL #	LAMINATE		
				L1	L2	L3
24"	14"	12"	EC2OY2412	\$977	\$1,075	\$1,172
30"	14"	12"	EC2OY3012	\$997	\$1,097	\$1,196
36"	14"	12"	EC2OY3612	\$1,017	\$1,119	\$1,220
42"	14"	12"	EC2OY4212	\$1,047	\$1,152	\$1,256
48"	14"	12"	EC2OY4812	\$1,077	\$1,185	\$1,292
60"	14"	12"	EC2OY6012	\$1,497	\$1,647	\$1,796
72"	14"	12"	EC2OY7212	\$1,937	\$2,131	\$2,324
84"	14"	12"	EC2OY8412	\$2,357	\$2,593	\$2,828

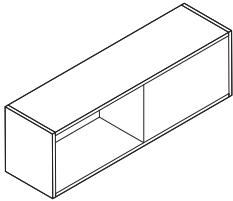

## 14" H

24"	14"	14 ¼"	EC2OY2414	\$987	\$1,086	\$1,184
30"	14"	14 ¼"	EC2OY3014	\$1,007	\$1,108	\$1,208
36"	14"	14 ¼"	EC2OY3614	\$1,027	\$1,130	\$1,232
42"	14"	14 ¼"	EC2OY4214	\$1,057	\$1,163	\$1,268
48"	14"	14 ¼"	EC2OY4814	\$1,087	\$1,196	\$1,304
60"	14"	14 ¼"	EC2OY6014	\$1,537	\$1,691	\$1,844
72"	14"	14 ¼"	EC2OY7214	\$1,977	\$2,175	\$2,372
84"	14"	14 ¼"	EC2OY8414	\$2,407	\$2,648	\$2,888

## SHARED STORAGE DIMENSIONS

Equity is measured from the center of the posts on each end of the panel. A standard shared storage is dimensioned to fit in a fully panel wrapped configuration. It is therefore 1-½" narrower than the nominal panel dimension. If you would like the shared storage to extend to cover the center of one post you will need to add an "E" to the shared storage item number. This will add ¾" to the width of the shared storage. If you would like the shared storage to extend to cover the center of both posts then you will need to add "EE", extending the shared storage by 1 ½" from the standard.

- E** . . . Covers center of 1 post
- EE** . . Covers center of 2 posts

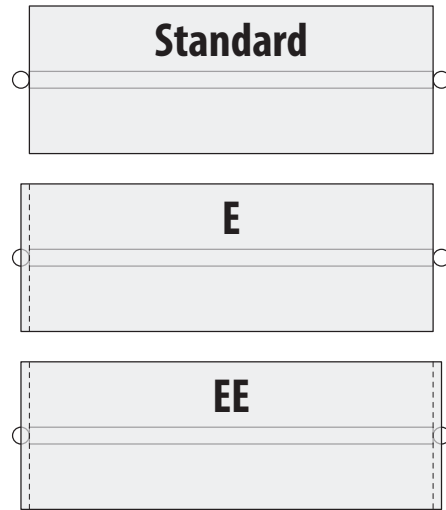

Panel Supported

						Options				
				W	D	Door		Extended Ends		
ES20	Equity Overhead	Y	Shared Storage	36	14		No Door	E	One End	\$21
						D	Door	EE	Both Ends	\$42
						MD	Markerboard Door			
ES20		Y		36	14	D		E		



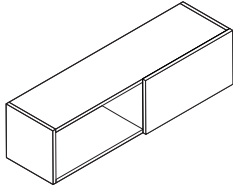

## 12" H w/Doors — includes 2 locks

W	D	H	MODEL #	LAMINATE		
				L1	L2	L3
24"	14"	12"	EC2OY2412(D/MD)	\$1,117	\$1,229	\$1,340
30"	14"	12"	EC2OY3012(D/MD)	\$1,147	\$1,262	\$1,376
36"	14"	12"	EC2OY3612(D/MD)	\$1,177	\$1,295	\$1,412
42"	14"	12"	EC2OY4212(D/MD)	\$1,207	\$1,328	\$1,448
48"	14"	12"	EC2OY4812(D/MD)	\$1,237	\$1,361	\$1,484
60"	14"	12"	EC2OY6012(D/MD)	\$1,687	\$1,856	\$2,024
72"	14"	12"	EC2OY7212(D/MD)	\$2,127	\$2,340	\$2,552
84"	14"	12"	EC2OY8412(D/MD)	\$2,507	\$2,758	\$3,008

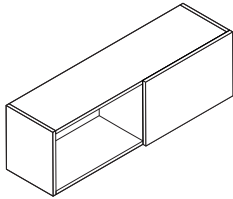

## 14" H w/Doors — includes 2 locks

W	D	H	MODEL #	LAMINATE		
				L1	L2	L3
24"	14"	14 ¼"	EC2OY2414(D/MD)	\$1,157	\$1,273	\$1,388
30"	14"	14 ¼"	EC2OY3014(D/MD)	\$1,177	\$1,295	\$1,412
36"	14"	14 ¼"	EC2OY3614(D/MD)	\$1,197	\$1,317	\$1,436
42"	14"	14 ¼"	EC2OY4214(D/MD)	\$1,227	\$1,350	\$1,472
48"	14"	14 ¼"	EC2OY4814(D/MD)	\$1,257	\$1,383	\$1,508
60"	14"	14 ¼"	EC2OY6014(D/MD)	\$1,707	\$1,878	\$2,048
72"	14"	14 ¼"	EC2OY7214(D/MD)	\$2,157	\$2,373	\$2,588
84"	14"	14 ¼"	EC2OY8414(D/MD)	\$2,627	\$2,890	\$3,152

### Specify

1. Model #
2. Options
3. Laminate

### Shared Storage

Includes matching ABS edge band.

# Tackboards

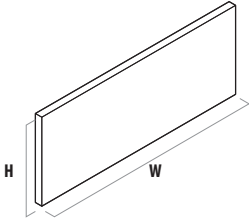

## 12" H

W	MODEL #	FABRIC							
		A	B	C	D	E	F	G	H
24"	EP1TB2412	\$200	\$225	\$250	\$300	\$400	\$500	\$600	\$700
30"	EP1TB3012	\$250	\$275	\$300	\$350	\$450	\$550	\$650	\$750
36"	EP1TB3612	\$300	\$325	\$350	\$400	\$500	\$600	\$700	\$800
42"	EP1TB4212	\$325	\$350	\$375	\$425	\$525	\$625	\$725	\$825
48"	EP1TB4812	\$350	\$375	\$400	\$450	\$550	\$650	\$750	\$850
60"	EP1TB6012	\$400	\$425	\$450	\$500	\$600	\$700	\$800	\$900

## 20" H

24"	EP1TB2420	\$300	\$325	\$350	\$400	\$500	\$600	\$700	\$800
30"	EP1TB3020	\$325	\$350	\$375	\$425	\$525	\$625	\$725	\$825
36"	EP1TB3620	\$350	\$375	\$400	\$450	\$550	\$650	\$750	\$850
42"	EP1TB4220	\$375	\$400	\$425	\$475	\$575	\$675	\$775	\$875
48"	EP1TB4820	\$400	\$425	\$450	\$500	\$600	\$700	\$800	\$900
60"	EP1TB6020	\$450	\$475	\$500	\$550	\$650	\$750	\$850	\$950

## 25" H

24"	EP1TB2425	\$350	\$375	\$400	\$450	\$550	\$650	\$750	\$850
30"	EP1TB3025	\$375	\$400	\$425	\$475	\$575	\$675	\$775	\$875
36"	EP1TB3625	\$400	\$425	\$450	\$500	\$600	\$700	\$800	\$900
42"	EP1TB4225	\$425	\$450	\$475	\$525	\$625	\$725	\$825	\$925
48"	EP1TB4825	\$450	\$475	\$500	\$550	\$650	\$750	\$850	\$950
60"	EP1TB6025	\$500	\$525	\$550	\$600	\$700	\$800	\$900	\$1,000

## 36" H

24"	EP1TB2436	\$400	\$425	\$450	\$500	\$600	\$700	\$800	\$900
30"	EP1TB3036	\$450	\$475	\$500	\$550	\$650	\$750	\$850	\$950
36"	EP1TB3636	\$475	\$500	\$525	\$575	\$675	\$775	\$875	\$975
42"	EP1TB4236	\$500	\$525	\$550	\$600	\$700	\$800	\$900	\$1,000
48"	EP1TB4836	\$525	\$550	\$575	\$625	\$725	\$825	\$925	\$1,025
60"	EP1TB6036	\$575	\$600	\$625	\$675	\$775	\$875	\$975	\$1,075

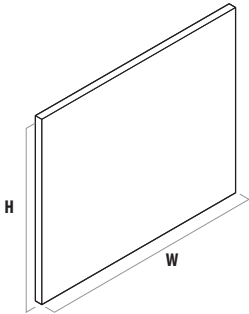

Panel Supported

### Specify

1. Model #
2. Fabric

### Application Notes

Specify in areas where heavy tacking application is required.

Solid core construction will easily accept T-pins, push pins and thumbtacks.

Clips attach unit to slotted standards.

		W	H	Options	
EW1	Tackboard	48	20	Extended Ends	
				E One End	\$21
				EE Both Ends	\$42
EP1TB		36	20	E	



## Wall Mounted Channel

W	D	H	H (Actual)	MODEL #	PAINT		
					P1	P2	P3
2 7/8"	3/4"	29"	23"	EP3WMC29	\$112	\$116	\$122
2 7/8"	3/4"	41"	35"	EP3WMC41	\$112	\$116	\$122
2 7/8"	3/4"	49"	43"	EP3WMC49	\$114	\$120	\$128
2 7/8"	3/4"	54"	49"	EP3WMC54	\$116	\$122	\$129
2 7/8"	3/4"	61"	55"	EP3WMC61	\$130	\$135	\$145
2 7/8"	3/4"	66"	60"	EP3WMC66	\$133	\$144	\$148
2 7/8"	3/4"	81"	75"	EP3WMC81	\$162	\$168	\$178
2 7/8"	3/4"	120"	120"	EP3WMC120	\$249	\$262	\$276

### Specify

1. Model #
2. Paint

### Application Notes

Allows hanging of all components and accessories on reinforced building walls.

Painted extruded aluminum with a plastic insert which snaps in place, covering mounting screws.

**NOTE: Neutral Posture, Inc. assumes no responsibility for wall construction or performance of fasteners used.**

### Assembly

- Included**
- Extruded aluminum channel
  - Insert which snaps into place

---

## LIGHTING

---

Just as the design of a work environment is important, a company's investment in workplace lighting is equally such. Light empowers a person's work, influences their mood and helps them focus. Workers need well-lit spaces to be productive

and feel their best. Developing a work environment that supports worker well being and performance through the use of lighting will reduce employee stress, absenteeism and accidents while increasing work performance.

# LIGHTING

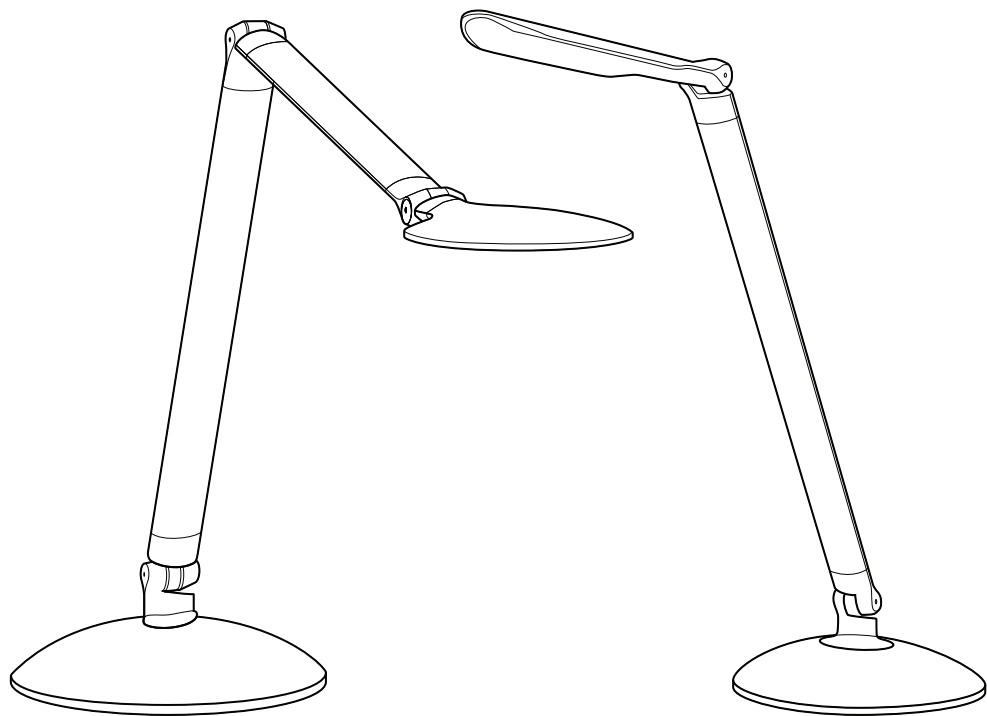

# Task Lights

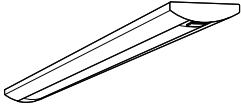

## REED Premier — Stand alone w/18-watt power supply

DESCRIPTION	H	W	D	WATTAGE	MODEL #	LIST
Suggested Shelf size 24" – 36"	½"	16 ½"	2"	8.0	LRPSO-17-SA	\$397
Suggested Shelf size 30" – 42"	½"	23 ¼"	2"	12.4	LRPSO-24-SA	\$517

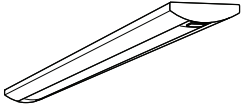

## REED Premier — Stand alone or Starter w/60-watt power supply

Suggested Shelf size 24" – 36"	½"	16 ½"	2"	8.0	LRPSO-17-ST	\$477
Suggested Shelf size 30" – 42"	½"	23 ¼"	2"	12.4	LRPSO-24-ST	\$597
Suggested Shelf size 42" – 48"	½"	30"	2"	16.4	LRPSO-31-ST	\$627
Suggested Shelf size 54" – 60"	½"	43 ¾"	2"	24.2	LRPSO-44-ST	\$777
Suggested Shelf size >72"	½"	57 ½"	2"	31.2	LRPSO-58-ST	\$957

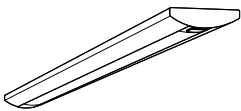

## REED Premier — Extension

Suggested Shelf size 24" – 36"	½"	16 ½"	2"	8.0	LRPSO-17-EX	\$357
Suggested Shelf size 30" – 42"	½"	23 ¼"	2"	12.4	LRPSO-24-EX	\$497
Suggested Shelf size 42" – 48"	½"	30"	2"	16.4	LRPSO-31-EX	\$527
Suggested Shelf size 54" – 60"	½"	43 ¾"	2"	24.2	LRPSO-44-EX	\$697
Suggested Shelf size >72"	½"	57 ½"	2"	31.2	LRPSO-58-EX	\$877

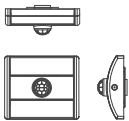

## REED Premier — Accessories

Occupancy sensor kit	¾"	2"	2"		LRP-OS	\$307
----------------------	----	----	----	--	--------	-------

### Specify

1. Model #

### REED Premier

Properly diffused light provides a softly blended light pattern that reduces eye strain.

A single-touch on/off and touch and hold continuous dimming pad with last state memory.

The automatic turn off feature comes standard and will turn the fixture off after 10 hours of continuous use (±15 mins).

### Specify Notes

60-watt power supply is required when interlinking.

Total interlinked system wattage cannot exceed 54 watts. See the interlinking combination chart for reference.

Extension fixtures come standard with 8" and 30" interlinking cords.

Not recommended to interlink standard and high output versions.

One occupancy sensor needed per string of interlinked fixtures.

### Interlinking Combination Chart

17"	24"	31"	44"	58"	17"	24"	31"	44"	58"
6	0	0	0	0	1	3	0	0	0
5	1	0	0	0	1	2	1	0	0
5	0	0	0	0	1	1	2	0	0
4	1	0	0	0	1	0	2	0	0
4	0	1	0	0	1	0	1	1	0
4	0	0	0	0	1	0	0	1	0
3	2	0	0	0	1	0	0	0	1
3	1	1	0	0	0	4	0	0	0
3	0	1	0	0	0	3	1	0	0
3	0	0	1	0	0	2	1	0	0
3	0	0	0	0	0	1	1	1	0
2	3	0	0	0	0	1	0	0	1
2	2	0	0	0	0	0	3	0	0
2	0	2	0	0	0	0	2	0	0
2	0	1	0	0	0	0	0	1	1
2	0	0	1	0	0	0	0	1	0
2	0	0	0	1	0	0	0	0	2
2	0	0	0	0	0	0	0	0	0



## T5 – Task Light

DESCRIPTION	H	W	D	MODEL #	LIST
Use with 24" and wider overhead	1 ½"	19"	4"	<b>EL4T5E19S</b>	\$259
Use with 30" and wider overhead	1 ½"	25"	4"	<b>EL4T5E25S</b>	\$268
Use with 42" and wider overhead	1 ½"	37"	4"	<b>EL4T5E37S</b>	\$275
Use with 60" and wider overhead	1 ½"	49"	4"	<b>EL4T5E49S</b>	\$291

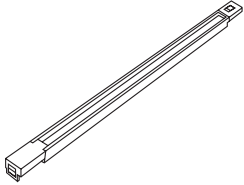

## LED – Task Light

Use with 24" and wider overhead	1"	16"	1"	<b>EL4LED16</b>	\$495
Use with 30" and wider overhead	1"	25"	1"	<b>EL4LED25</b>	\$595
Use with 42" and wider overhead	1"	31"	1"	<b>EL4LED31</b>	\$655
Use with 60" and wider overhead	1"	37"	1"	<b>EL4LED37</b>	\$727

### Specify

1. Model #

### Application Notes

All task lights mount into the recess in the underside of overhead cabinets and shelves at least 6" wider than task light width.

All task lights are TCLP compliant and meet requirements of California Title 20 and Title 24.

### T5 Task Light

120v and includes T5 cool white (4100K) fluorescent lamp, electronic ballast, 9' grounded cord-set, prismatic lens, rocker switch, one cord exit management clip and mounting hardware. Housings are black.

T5 task lights come with mounting supports.

**City of Chicago Installations**  
Specify suffix – CH  
and add \$45 list.

Example: EL4T525S-CH

### LED

- Consumes only 9.4 Watts
- Color temperature: 3300 K
- Non-handed toggle switch location
- Cord location can be either end

LED task lights are magnetic and require no mounting supports.

# Freestanding Lights

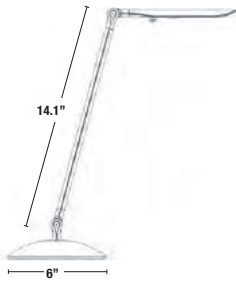

## Voyage — Single arm

DESCRIPTION	MODEL #	LIST
Freestanding	LVOY-S-FS-(B,W,S)	\$797
Freestanding w/occupancy sensor	LVOY-S-FS-(B,W,S)-OS	\$977
Freestanding USB	LVOY-S-FSUSB-(B,W,S)	\$857
Freestanding USB w/occupancy sensor	LVOY-S-FSUSB-(B,W,S)-OS	\$1,057
Surface Mount	LVOY-S-SM-(B,W,S)	\$797
Surface Mount w/occupancy sensor	LVOY-S-SM-(B,W,S)-OS	\$977
Clamp Mount	LVOY-S-CM-(B,W,S)	\$797
Clamp Mount w/occupancy sensor	LVOY-S-CM-(B,W,S)-OS	\$977

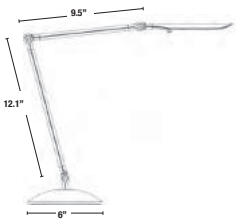

## Voyage — Double arm

DESCRIPTION	MODEL #	LIST
Freestanding	LVOY-D-FS-(B,W,S)	\$877
Freestanding w/occupancy sensor	LVOY-D-FS-(B,W,S)-OS	\$1,057
Freestanding USB	LVOY-D-FSUSB-(B,W,S)	\$977
Freestanding USB w/occupancy sensor	LVOY-D-FSUSB-(B,W,S)-OS	\$1,127
Surface Mount	LVOY-D-SM-(B,W,S)	\$877
Surface Mount w/occupancy sensor	LVOY-D-SM-(B,W,S)-OS	\$1,057
Clamp Mount	LVOY-D-CM-(B,W,S)	\$977
Clamp Mount w/occupancy sensor	LVOY-D-CM-(B,W,S)-OS	\$1,057

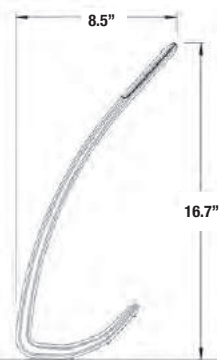

## Amble

DESCRIPTION	MODEL #	LIST
standard (white only)	LAMB-W	\$657
w/USB and occupancy sensor	LAMB-USB-OS-(B,W,S,G)	\$827
w/USB, occupancy sensor and rechargeable battery	LAMB-USB-OS-BAT-(B,W,S,G)	\$997

### Specify

1. Model #

### Voyage

Properly diffused light provides a softly blended light pattern that reduces eye strain.

A single-touch on/off and touch and hold continuous dimming pad with last state memory.

The automatic turn off feature comes standard and will turn the fixture off after 10 hours of continuous use.

The optional occupancy sensor will turn the fixture off after 30 minutes of inactivity and back on as the user re-enters the workspace. If occupant is present, the light will remain on.

#### Color Options

**B** – Black  
**W** – White  
**S** – Silver

### Amble

Adjustable illumination achieved by rocking back or forth into three positions.

Optional dedicated USB charging port built into base for easy charging of mobile devices on your desktop.

Optional occupancy sensor shuts the fixture off after 30 minutes of inactivity.

Optional rechargeable lithium ion battery for wireless use up to 6 hours.

#### Color Options

**B** – Black  
**W** – White  
**S** – Silver  
**G** – Ash Gray



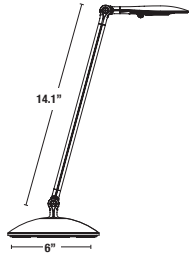

## Revo — Single arm

DESCRIPTION	MODEL #	LIST
Freestanding	LREV-S-FS-(B,W,S)	\$797
Freestanding w/occupancy sensor	LREV-S-FS-(B,W,S)-OS	\$977
Freestanding USB	LREV-S-FSUSB-(B,W,S)	\$877
Freestanding USB w/occupancy sensor	LREV-S-FSUSB-(B,W,S)-OS	\$1,007
Surface Mount	LREV-S-SM-(B,W,S)	\$797
Surface Mount w/occupancy sensor	LREV-S-SM-(B,W,S)-OS	\$977
Clamp Mount	LREV-S-CM-(B,W,S)	\$797
Clamp Mount w/occupancy sensor	LREV-S-CM-(B,W,S)-OS	\$977

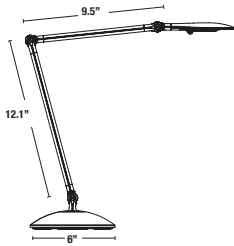

## Revo — Double Arm

DESCRIPTION	MODEL #	LIST
Freestanding	LREV-D-FS-(B,W,S)	\$877
Freestanding w/occupancy sensor	LREV-D-FS-(B,W,S)-OS	\$1,057
Freestanding USB	LREV-D-FSUSB-(B,W,S)	\$977
Freestanding USB w/occupancy sensor	LREV-D-FSUSB-(B,W,S)-OS	\$1,127
Surface Mount	LREV-D-SM-(B,W,S)	\$877
Surface Mount w/occupancy sensor	LREV-D-SM-(B,W,S)-OS	\$977
Clamp Mount	LREV-D-CM-(B,W,S)	\$877
Clamp Mount w/occupancy sensor	LREV-D-CM-(B,W,S)-OS	\$977

### Specify

1. Model #

### Application Notes

Properly diffused light source under the round head provides a softly blended light pattern that reduces eye strain.

Single-touch on/off and touch and hold continuous dimming pad with last state memory.

The automatic turn off feature comes standard and will turn the fixture off after 10 hours of continuous use.

The optional occupancy sensor will turn the fixture off after 30 minutes of inactivity and back on as the user re-enters the workspace. If occupant is present, the light will remain on.

### Color Options

**B** – Black  
**W** – White  
**S** – Silver

# Tables

## General Info

### Step 1 – Model #

		Shape	D	W
TB	Table	R Round S Square RCT Rectangle OT Oval	34	69
TB		RCT	34	69

### Step 1 – Surface Finish

Laminate	
PW-STK	Studio Teak
PW-STK	

### Step 2 – Edge Finish

Edge Band	
EB-STK	Studio Teak
EB-STK	

### Step 3 – Trim Finish

Paints	
301	Champagne
301	

## FEATURES

### BASE TYPES

- X Base
- Y Base w/ or w/o adjustable bar support
- Tapered Leg

### BASE OPTIONS

- Bar height
- Flip top
- Casters
- Polished and satin chrome finishes available in addition to paint

**NOTE: Not all options are available on all bases.**

### WORKSURFACE TYPES

- Round
- Square
- Rectangular
- Oval

### LEVELERS

Adjustable height levelers are included at no additional cost on all models. The levels are  $\frac{3}{8}$  – 16 x  $\frac{3}{4}$ " long shank. Leveler extensions can be ordered separately. Please contact Customer Service for information on ordering leveler extensions. Casters can be ordered in place of levelers for an upcharge on most standard height tables.

### SAFETY

For safety and stability purposes, the caster and flip top options cannot be added to bar height tables or the following table models: TBR60, TBS48, TBS60, TBOT54120, TBOT60144.

### CUSTOM TABLES

Custom size tables and custom height bases are available upon request, pending Engineering approval. Customization charges may apply. Contact Customer Service for additional information and pricing.

## CONSTRUCTION

### X BASES

X bases are made from cast aluminum with 2  $\frac{1}{4}$ " tubing OD x 13 gauge.

### Y BASE

Y base is made from cast aluminum with 2  $\frac{1}{4}$ " steel tube.

### X BASE MOUNTING PLATES

X base mounting plates are made of steel 4 gauge x 12" x 12" or 8" x 8".

### Y BASE MOUNTING PLATES

Y base mounting plates are made from 0.187" x 6" x 8" fabricated steel.

### WORKSURFACES

All worksurfaces are made with a core, high pressure laminate and edge band. All non-woodgrain edge bands are made of ABS material. All woodgrain edge bands are made of PVC material. The overall thickness is 1  $\frac{1}{8}$ ".

### WORKSURFACE HEIGHTS

Standard	27 $\frac{3}{4}$ "
Bar Height	40 $\frac{3}{4}$ "

## SURFACE MATERIALS

### WORKSURFACE

- Laminate
- Edge band

### X BASES

Paint

### Y BASE

Paint

### TAPERED LEGS

Paint

### HEIGHT ADJUSTABLE BASE

Black or silver

# TABLES

Free Standing



# Tables

## Occasional – Round



### Round — w/X base

DESCRIPTION	H	W	D	MODEL #	LAMINATE			PAINT	
					L1	L2	L3	P2	P3
X base	29"	29 ¾"	29 ¾"	<b>TBR30X</b>	\$1,125	\$1,238	\$1,350	+ \$100	+ \$200
X base	29"	35 ¾"	35 ¾"	<b>TBR36X</b>	\$1,150	\$1,265	\$1,380	+ \$100	+ \$200
X base	29"	41 ¾"	41 ¾"	<b>TBR42X</b>	\$1,225	\$1,348	\$1,470	+ \$100	+ \$200
X base	29"	47 ¾"	47 ¾"	<b>TBR48X</b>	\$1,510	\$1,661	\$1,812	+ \$100	+ \$200

### Options for Round Tables — w/X base

DESCRIPTION	OPTION CODE	UPCHARGE
Bar height	<b>BH</b>	+ \$100
Casters (set of 4)	<b>C</b>	+ \$100
Flip top	<b>FT</b>	+ \$200



### Round — w/Tapered legs

DESCRIPTION	H	W	D	MODEL #	LAMINATE			PAINT	
					L1	L2	L3	P2	P3
4 Tapered legs	29"	29 ¾"	29 ¾"	<b>TBR30T</b>	\$1,600	\$1,760	\$1,920	+ \$100	+ \$200
4 Tapered legs	29"	35 ¾"	35 ¾"	<b>TBR36T</b>	\$1,625	\$1,788	\$1,950	+ \$100	+ \$200
4 Tapered legs	29"	41 ¾"	41 ¾"	<b>TBR42T</b>	\$1,650	\$1,815	\$1,980	+ \$100	+ \$200
4 Tapered legs	29"	47 ¾"	47 ¾"	<b>TBR48T</b>	\$1,675	\$1,843	\$2,010	+ \$100	+ \$200

### Options for Round Tables — w/Tapered legs

DESCRIPTION	OPTION CODE	UPCHARGE
Casters (set of 4)	<b>C</b>	+ \$100



### Round — w/disc base

DESCRIPTION	H	W	D	MODEL #	LAMINATE			PAINT	
					L1	L2	L3	P2	P3
Disc base	29"	29 ¾"	29 ¾"	<b>TBR30D</b>	\$2,127	\$2,340	\$2,552	+ \$100	+ \$200
Disc base	29"	35 ¾"	35 ¾"	<b>TBR36D</b>	\$2,227	\$2,450	\$2,672	+ \$100	+ \$200

### Options for Round Tables — w/Disc base

DESCRIPTION	OPTION CODE	UPCHARGE
Bar height	<b>BH</b>	+ \$100
Flip top	<b>FT</b>	+ \$200

Free Standing

#### Specify

1. Model #
2. Options
3. Laminate
4. Edge band
5. Base paint

#### Grain Direction

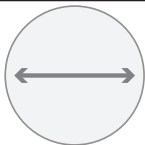

Shape		D	Base	
<b>TB</b>	<b>Table</b>	<b>30</b>	<b>X</b>	<b>X base</b>
	R Round		T	Tapered legs
	S Square		D	Disc base
	RCT Rectangle			
	OT Oval			
<b>TB</b>	<b>R</b>	<b>30</b>	<b>X</b>	

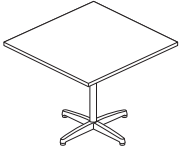

## Square — w/X base

DESCRIPTION	H	W	D	MODEL #	LAMINATE			PAINT	
					L1	L2	L3	P2	P3
X base	29"	29 3/4"	29 3/4"	<b>TBS30X</b>	\$1,125	\$1,238	\$1,350	+ \$100	+ \$200
X base	29"	35 3/4"	35 3/4"	<b>TBS36X</b>	\$1,200	\$1,320	\$1,440	+ \$100	+ \$200
X base	29"	41 3/4"	41 3/4"	<b>TBS42X</b>	\$1,250	\$1,375	\$1,500	+ \$100	+ \$200

## Options for Square Tables — w/X base

DESCRIPTION	OPTION CODE	UPCHARGE
Bar height	<b>BH</b>	+ \$100
Casters (set of 4)	<b>C</b>	+ \$100
Flip top	<b>FT</b>	+ \$200

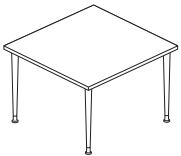

## Square — w/Tapered legs

DESCRIPTION	H	W	D	MODEL #	LAMINATE			PAINT	
					L1	L2	L3	P2	P3
4 Tapered Legs	29"	29 3/4"	29 3/4"	<b>TBS30T</b>	\$1,600	\$1,760	\$1,920	+ \$100	+ \$200
4 Tapered Legs	29"	35 3/4"	35 3/4"	<b>TBS36T</b>	\$1,625	\$1,788	\$1,950	+ \$100	+ \$200
4 Tapered Legs	29"	41 3/4"	41 3/4"	<b>TBS42T</b>	\$1,635	\$1,799	\$1,962	+ \$100	+ \$200
4 Tapered Legs	29"	47 3/4"	47 3/4"	<b>TBS48T</b>	\$1,650	\$1,815	\$1,980	+ \$100	+ \$200

## Options for Square Tables — w/Tapered legs

DESCRIPTION	OPTION CODE	UPCHARGE
Casters (set of 4)	<b>C</b>	+ \$100

Free Standing

### Specify

1. Model #
2. Options
3. Laminate
4. Edge band
5. Base paint

### Grain Direction



TB	Table	Shape	D	Base
		R Round	<b>30</b>	<b>X X base</b>
		<b>S Square</b>		T Tapered legs
		RCT Rectangle		
		OT Oval		
<b>TB</b>		<b>S</b>	<b>30</b>	<b>X</b>

# Tables

## Conference – Oval



### Oval — w/Y base

DESCRIPTION	H	W	D	MODEL #	LAMINATE			PAINT	
					L1	L2	L3	P2	P3
w/stretcher	29"	71 3/4"	35 3/4"	<b>TBOT3672Y</b>	\$3,190	\$3,509	\$3,828	+\$200	+\$300
w/stretcher	29"	95 3/4"	47"	<b>TBOT4896Y</b>	\$5,225	\$5,748	\$6,270	+\$200	+\$300
w/stretcher	29"	119 3/4"	47"	<b>TBOT48120Y</b>	\$6,395	\$7,035	\$7,674	+\$200	+\$300

### Options for Oval Tables — w/Y base

DESCRIPTION	OPTION CODE	UPCHARGE
Bar height	<b>BH</b>	+\$300
Casters (set of 4)	<b>C</b>	+\$100
Flip top	<b>FT</b>	+\$300

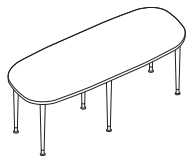

### Oval — w/Tapered legs

DESCRIPTION	H	W	D	MODEL #	LAMINATE			PAINT	
					L1	L2	L3	P2	P3
6 Tapered legs	29"	71 3/4"	35 3/4"	<b>TBOT3672T</b>	\$3,200	\$3,520	\$3,840	+\$250	+\$350
6 Tapered legs	29"	95 3/4"	47"	<b>TBOT4896T</b>	\$3,500	\$3,850	\$4,200	+\$250	+\$350
6 Tapered legs*	29"	119 3/4"	47"	<b>TBOT48120T</b>	\$3,850	\$4,235	\$4,620	+\$250	+\$350
6 Tapered legs*	29"	119 3/4"	53 3/4"	<b>TBOT54120T</b>	\$6,900	\$7,590	\$8,280	+\$250	+\$350
6 Tapered legs*	29"	143 3/4"	59 3/4"	<b>TBOT60144T</b>	\$7,500	\$8,250	\$9,000	+\$250	+\$350

\* Includes a support rail

### Options for Oval Tables — w/Tapered legs

DESCRIPTION	OPTION CODE	UPCHARGE
Casters (set of 6)	<b>C</b>	+\$150

#### Specify

1. Model #
2. Options
3. Laminate
4. Edge band
5. Base paint

#### Grain Direction

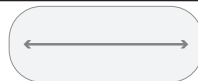

		Shape	D	W	Base	
<b>TB</b>	<b>Table</b>	R Round S Square RCT Rectangle <b>OT Oval</b>	<b>34</b>	<b>69</b>	<b>Y</b>	<b>Y base</b> T Tapered legs
<b>TB</b>		<b>OT</b>	<b>34</b>	<b>69</b>	<b>Y</b>	



## Rectangle — w/Y base

DESCRIPTION	H	W	D	MODEL #	LAMINATE			PAINT	
					L1	L2	L3	P2	P3
w/o stretcher	29"	47 ¾"	29 ¾"	TBRCT3048Y	\$1,415	\$1,557	\$1,698	+ \$200	+ \$300
w/stretcher	29"	58 ½"	35 ½"	TBRCT3660Y	\$2,035	\$2,239	\$2,442	+ \$200	+ \$300
w/stretcher	29"	59 ¾"	29 ¾"	TBRCT3060Y	\$1,725	\$1,898	\$2,070	+ \$200	+ \$300
w/stretcher	29"	69 ¼"	34"	TBRCT3469Y	\$3,065	\$3,372	\$3,678	+ \$200	+ \$300
w/stretcher	29"	71 ¾"	29 ¾"	TBRCT3072Y	\$2,035	\$2,239	\$2,442	+ \$200	+ \$300
w/stretcher	29"	71 ¾"	35 ¾"	TBRCT3672Y	\$2,415	\$2,657	\$2,898	+ \$200	+ \$300
w/stretcher*	29"	79 ¼"	34"	TBRCT3479Y	\$3,065	\$3,372	\$3,678	+ \$200	+ \$300
w/stretcher*	29"	83 ¾"	41 ¾"	TBRCT4284Y	\$3,275	\$3,603	\$3,930	+ \$200	+ \$300
w/stretcher*	29"	95 ¾"	47 ¾"	TBRCT4896Y	\$4,165	\$4,582	\$4,998	+ \$200	+ \$300

\* Includes a support rail

## Options for Rectangle Tables — w/Y base

DESCRIPTION	OPTION CODE	UPCHARGE
Bar height	BH	+ \$300
Casters (set of 4)	C	+ \$100
Flip top	FT	+ \$300

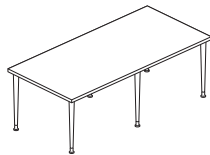

## Rectangle — w/Tapered legs

DESCRIPTION	H	W	D	MODEL #	LAMINATE			PAINT	
					L1	L2	L3	P2	P3
4 Tapered legs	29"	47 ¾"	29 ¾"	TBRCT3048T	\$1,900	\$2,090	\$2,280	+ \$250	+ \$350
4 Tapered legs	29"	58 ½"	35 ½"	TBRCT3660T	\$2,200	\$2,420	\$2,640	+ \$250	+ \$350
4 Tapered legs	29"	59 ¾"	29 ¾"	TBRCT3060T	\$2,100	\$2,310	\$2,520	+ \$250	+ \$350
6 Tapered legs	29"	69 ¼"	34"	TBRCT3469T	\$2,300	\$2,530	\$2,760	+ \$250	+ \$350
6 Tapered legs	29"	71 ¾"	29 ¾"	TBRCT3072T	\$2,100	\$2,310	\$2,520	+ \$250	+ \$350
6 Tapered legs	29"	71 ¾"	35 ¾"	TBRCT3672T	\$2,300	\$2,530	\$2,760	+ \$250	+ \$350
6 Tapered legs*	29"	79 ¼"	34"	TBRCT3479T	\$2,500	\$2,750	\$3,000	+ \$250	+ \$350
6 Tapered legs*	29"	83 ¾"	41 ¾"	TBRCT4284T	\$2,750	\$3,025	\$3,300	+ \$250	+ \$350
6 Tapered legs*	29"	95 ¾"	47 ¾"	TBRCT4896T	\$2,850	\$3,135	\$3,420	+ \$250	+ \$350

\* Includes a support rail

## Options for Rectangle Tables — w/Tapered legs

DESCRIPTION	OPTION CODE	UPCHARGE
Casters (set of 6)	C	+ \$150

### Specify

1. Model #
2. Options
3. Laminate
4. Edge band
5. Base paint

### Grain Direction

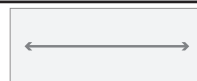

	Shape	D	W	Base
TB Table	R Round S Square RCT Rectangle OT Oval	34	69	Y Y base T Tapered legs
TB	RCT	34	69	Y

# Tables

## Electric Height Adjustable

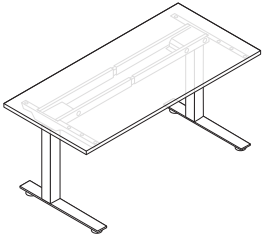

### 24" D

H	W	D	MODEL #	LAMINATE		
				L1	L2	L3
24" – 50"	48"	24"	TBRCT2448H	\$2,177	\$2,395	\$2,612
24" – 50"	54"	24"	TBRCT2454H	\$2,227	\$2,450	\$2,672
24" – 50"	60"	24"	TBRCT2460H	\$2,277	\$2,505	\$2,732
24" – 50"	66"	24"	TBRCT2466H	\$2,327	\$2,560	\$2,792
24" – 50"	72"	24"	TBRCT2472H	\$2,377	\$2,615	\$2,852
24" – 50"	78"	24"	TBRCT2478H	\$2,427	\$2,670	\$2,912
24" – 50"	84"	24"	TBRCT2484H	\$2,477	\$2,725	\$2,972

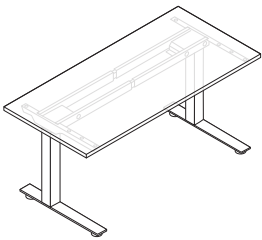

### 30" D

H	W	D	MODEL #	LAMINATE		
				L1	L2	L3
24" – 50"	48"	30"	TBRCT3048H	\$2,227	\$2,450	\$2,672
24" – 50"	54"	30"	TBRCT3054H	\$2,277	\$2,505	\$2,732
24" – 50"	60"	30"	TBRCT3060H	\$2,327	\$2,560	\$2,792
24" – 50"	66"	30"	TBRCT3066H	\$2,377	\$2,615	\$2,852
24" – 50"	72"	30"	TBRCT3072H	\$2,427	\$2,670	\$2,912
24" – 50"	78"	30"	TBRCT3078H	\$2,477	\$2,725	\$2,972
24" – 50"	84"	30"	TBRCT3084H	\$2,527	\$2,780	\$3,032

Free Standing

#### Specify

1. Model #
2. Laminate
3. Edge band
4. Support color  
*Black or Silver*

#### Application Notes

**Electric Height Adjustable Base**  
Adjustable height bases can be used with 24" & 30" deep worksurfaces. Worksurfaces must be between 48" – 84" wide.

Adjustable height bases have a capacity of 264 lbs evenly distributed.  
Comes with four position memory controller.

Anti-collision stops and reverses the travel of the table when the table collides with a fixed object during operation.  
3-stage legs offer a large height adjustment range of 24" – 50".





## 24" D

H	W	D	MODEL #	LAMINATE		
				L1	L2	L3
24" – 50"	42"	24"	TBRCT2442PH	\$3,007	\$3,308	\$3,608
24" – 50"	48"	24"	TBRCT2448PH	\$3,057	\$3,363	\$3,668
24" – 50"	54"	24"	TBRCT2454PH	\$3,107	\$3,418	\$3,728
24" – 50"	60"	24"	TBRCT2460PH	\$3,157	\$3,473	\$3,788
24" – 50"	66"	24"	TBRCT2466PH	\$3,307	\$3,638	\$3,968
24" – 50"	72"	24"	TBRCT2472PH	\$3,357	\$3,693	\$4,028
24" – 50"	78"	24"	TBRCT2478PH	\$3,407	\$3,748	\$4,088
24" – 50"	84"	24"	TBRCT2484PH	\$3,507	\$3,858	\$4,208



## 30" D

H	W	D	MODEL #	LAMINATE		
				L1	L2	L3
24" – 50"	42"	30"	TBRCT3042PH	\$3,057	\$3,363	\$3,668
24" – 50"	48"	30"	TBRCT3048PH	\$3,107	\$3,418	\$3,728
24" – 50"	54"	30"	TBRCT3054PH	\$3,307	\$3,638	\$3,968
24" – 50"	60"	30"	TBRCT3060PH	\$3,357	\$3,693	\$4,028
24" – 50"	66"	30"	TBRCT3066PH	\$3,407	\$3,748	\$4,088
24" – 50"	72"	30"	TBRCT3072PH	\$3,457	\$3,803	\$4,148
24" – 50"	78"	30"	TBRCT3078PH	3,507.00	\$3,858	\$4,208
24" – 50"	84"	30"	TBRCT3084PH	3,557.00	\$3,913	\$4,268

Free Standing

### Specify

1. Model #
2. Laminate
3. Edge band
4. Support color  
*Black or Silver*

### Application Notes

Provides 18" of vertical movement.

### Specification Guidelines

**Pneumatic Height Adjustable Base**  
Pneumatic height adjustable height bases can be used with 24" & 30" deep worksurfaces. Worksurfaces must be between 48" – 84" wide.

**NOTE: Adjustable worksurface meets BIFMA loading requirements for safety. Mechanism is designed to have up to 100 lbs. of load and function smoothly.**

# Privacy/Modesty Panels

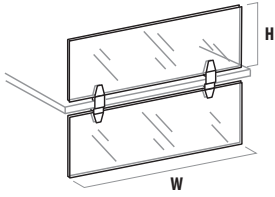

## Privacy & Modesty Panels

W	H	BRACKETS	MODEL #	SCREEN TYPE		
				CR	PG	TC
12"	12"	2	PRVMOD(CR/PG/TC)12	\$334	\$294	\$714
18"	12"	2	PRVMOD(CR/PG/TC)18	\$414	\$334	\$974
24"	12"	2	PRVMOD(CR/PG/TC)24	\$494	\$394	\$1,234
30"	12"	2	PRVMOD(CR/PG/TC)30	\$574	\$454	\$1,494
36"	12"	2	PRVMOD(CR/PG/TC)36	\$654	\$514	\$1,774
42"	12"	2	PRVMOD(CR/PG/TC)42	\$734	\$574	\$2,034
48"	12"	2	PRVMOD(CR/PG/TC)48	\$814	\$634	\$2,294
60"	12"	3	PRVMOD(CR/PG/TC)60	\$1,014	\$754	\$2,834

## Privacy Panels

12"	12"	2	PRV(CR/PG/TC)12	\$167	\$147	\$357
18"	12"	2	PRV(CR/PG/TC)18	\$207	\$167	\$487
24"	12"	2	PRV(CR/PG/TC)24	\$247	\$197	\$617
30"	12"	2	PRV(CR/PG/TC)30	\$287	\$227	\$747
36"	12"	2	PRV(CR/PG/TC)36	\$327	\$257	\$887
42"	12"	2	PRV(CR/PG/TC)42	\$367	\$287	\$1,017
48"	12"	2	PRV(CR/PG/TC)48	\$407	\$317	\$1,147
60"	12"	3	PRV(CR/PG/TC)60	\$507	\$377	\$1,417

## Modesty Panels

12"	12"	2	MOD(CR/PG/TC)12	\$167	\$147	\$357
18"	12"	2	MOD(CR/PG/TC)18	\$207	\$167	\$487
24"	12"	2	MOD(CR/PG/TC)24	\$247	\$197	\$617
30"	12"	2	MOD(CR/PG/TC)30	\$287	\$227	\$747
36"	12"	2	MOD(CR/PG/TC)36	\$327	\$257	\$887
42"	12"	2	MOD(CR/PG/TC)42	\$367	\$287	\$1,017
48"	12"	2	MOD(CR/PG/TC)48	\$407	\$317	\$1,147
60"	12"	3	MOD(CR/PG/TC)60	\$507	\$377	\$1,417

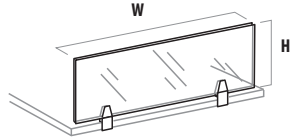

Free Standing

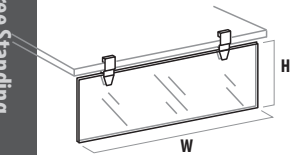

### Specify

1. Model #
  2. Insert type
  3. Insert color
- Trim - Brushed nickel only

### Screen Type

- CR . . Corian  
 PG . . Plexiglass  
 TC . . Textured Corian

### Corian Finishes

- Glacier White . . . . . **CR001**  
 Pearl Grey . . . . . **CR002**  
 Corian Clay . . . . . **CR003**  
 Silver Grey . . . . . **CR004**  
 Corian Grey . . . . . **CR005**

### Textured Corian Finishes

- Glacier White . . . . . **CR001T**  
 Pearl Grey . . . . . **CR002T**  
 Corian Clay . . . . . **CR003T**  
 Silver Grey . . . . . **CR004T**  
 Corian Grey . . . . . **CR005T**

### Plexiglass Finishes

- IC . . . Ice  
 SM . . Smoked  
 TR . . Translucent  
 LF . . Frost

### Application Notes

Screens are 1/4" thick.  
 Widths are 1" less than nominal to allow for 1/2" set-back on each side.

# Privacy/Modesty Panels

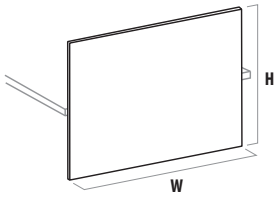

## Privacy & Modesty Panels — Laminate

W	H	BRACKETS	MODEL #	LAMINATE		
				L1	L2	L3
24"	27"	2	PRVMODLM24	\$497	\$547	\$596
30"	27"	2	PRVMODLM30	\$567	\$624	\$680
36"	27"	2	PRVMODLM36	\$607	\$668	\$728
42"	27"	2	PRVMODLM42	\$637	\$701	\$764
48"	27"	2	PRVMODLM48	\$677	\$745	\$812
60"	27"	3	PRVMODLM60	\$707	\$778	\$848

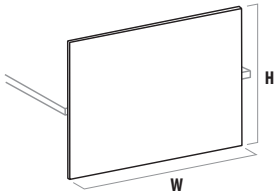

## Privacy & Modesty Panels — fabric

W	H	BRACKETS	MODEL #	FABRIC							
				A	B	C	D	E	F	G	H
24"	27"	2	PRVMODFA24	\$357	\$407	\$437	\$457	\$567	\$687	\$797	\$897
30"	27"	2	PRVMODFA30	\$377	\$447	\$477	\$497	\$607	\$727	\$827	\$937
36"	27"	2	PRVMODFA36	\$397	\$487	\$517	\$537	\$647	\$767	\$867	\$977
42"	27"	2	PRVMODFA42	\$417	\$517	\$557	\$577	\$687	\$797	\$907	\$1,017
48"	27"	2	PRVMODFA48	\$487	\$607	\$647	\$657	\$777	\$897	\$987	\$1,107
60"	27"	3	PRVMODFA60	\$617	\$747	\$797	\$807	\$907	\$1,037	\$1,137	\$1,247

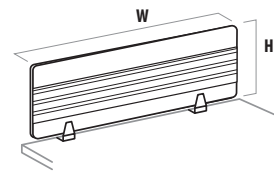

## Tackable Privacy & Slat Rail Combo

W	H	BRACKETS	MODEL #	FABRIC								PAINT		
				A	B	C	D	E	F	G	H	P1	P2	P3
12"	12"	2	PRVTKSR1212	\$207	\$257	\$307	\$357	\$407	\$467	\$557	\$707	+ \$25	+ \$50	+ \$75
18"	12"	2	PRVTKSR1218	\$237	\$297	\$347	\$397	\$447	\$507	\$597	\$747	+ \$25	+ \$50	+ \$75
24"	12"	2	PRVTKSR1224	\$267	\$337	\$387	\$437	\$487	\$547	\$637	\$787	+ \$25	+ \$50	+ \$75
30"	12"	2	PRVTKSR1230	\$297	\$377	\$427	\$477	\$557	\$587	\$677	\$827	+ \$25	+ \$50	+ \$75
36"	12"	2	PRVTKSR1236	\$347	\$417	\$467	\$517	\$597	\$757	\$857	\$1,027	+ \$25	+ \$50	+ \$75
42"	12"	2	PRVTKSR1242	\$377	\$457	\$507	\$557	\$637	\$777	\$897	\$1,067	+ \$25	+ \$50	+ \$75
48"	12"	2	PRVTKSR1248	\$407	\$497	\$547	\$597	\$677	\$797	\$957	\$1,107	+ \$25	+ \$50	+ \$75
60"	12"	3	PRVTKSR1260	\$447	\$537	\$587	\$637	\$717	\$817	\$997	\$1,147	+ \$25	+ \$50	+ \$75

### Specify

- Model #
  - Insert type
  - Insert color
- Trim - Brushed nickel only

### Screen Type

- CR .. Corian  
 PG .. Plexiglass  
 TC .. Textured Corian

### Corian Finishes

- Glacier White ..... **CR001**  
 Pearl Grey ..... **CR002**  
 Corian Clay ..... **CR003**  
 Silver Grey ..... **CR004**  
 Corian Grey ..... **CR005**

### Textured Corian Finishes

- Glacier White ..... **CR001T**  
 Pearl Grey ..... **CR002T**  
 Corian Clay ..... **CR003T**  
 Silver Grey ..... **CR004T**  
 Corian Grey ..... **CR005T**

### Plexiglass Finishes

- IC ... Ice  
 SM ... Smoked  
 TR ... Translucent  
 LF ... Frost

### Application Notes

Screens are ¼" thick.  
 Widths are 1" less than nominal to allow for ½" set-back on each side.

# Mobile Privacy Screens

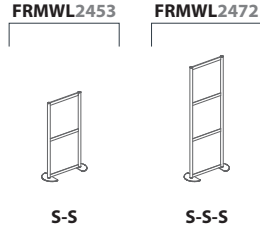

## 24" W

H	MODEL #	INFILL FINISHES		FRAME
		STANDARD	PREMIUM	BLACK/WHITE
53"	FRMWL2453-S-S	\$3,807	\$4,607	+ \$600
72"	FRMWL2472-S-S-S	\$3,907	\$4,707	+ \$600

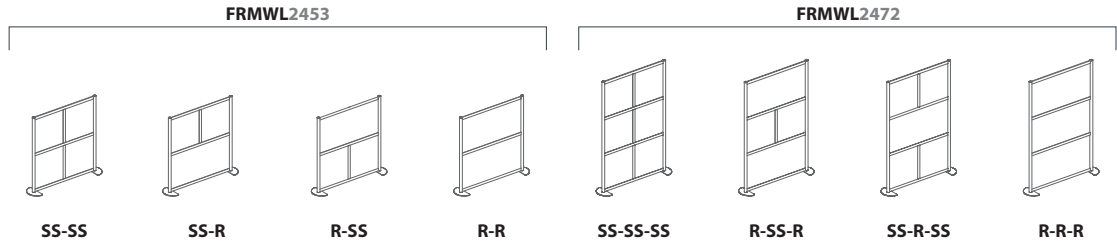

## 52" W

H	MODEL #	INFILL FINISHES		FRAME
		STANDARD	PREMIUM	BLACK/WHITE
53"	FRMWL5253-SS-SS	\$4,007	\$4,807	+ \$600
53"	FRMWL5253-SS-R	\$3,657	\$4,407	+ \$600
53"	FRMWL5253-R-SS	\$3,657	\$4,407	+ \$600
53"	FRMWL5253-R-R	\$3,307	\$4,057	+ \$600
72"	FRMWL5272-SS-SS-SS	\$4,107	\$5,107	+ \$600
72"	FRMWL5272-R-SS-R	\$4,327	\$5,607	+ \$600
72"	FRMWL5272-SS-R-SS	\$4,707	\$5,907	+ \$600
72"	FRMWL5272-R-R-R	\$4,107	\$5,207	+ \$600

### Specify

1. Model #
2. Frame color
3. Insert color

Standard Frame -  
Anodized Aluminum

### Frame Colors

Anodized Aluminum  
White  
Black

### Application Notes

**Frame**  
Includes hardware.

**Infills**  
Infills are available in grades A and B. See page 127 for available finishes.

**Bases**  
Bases are not included in the pricing. For base pricing see page 127.

# Mobile Privacy Screens

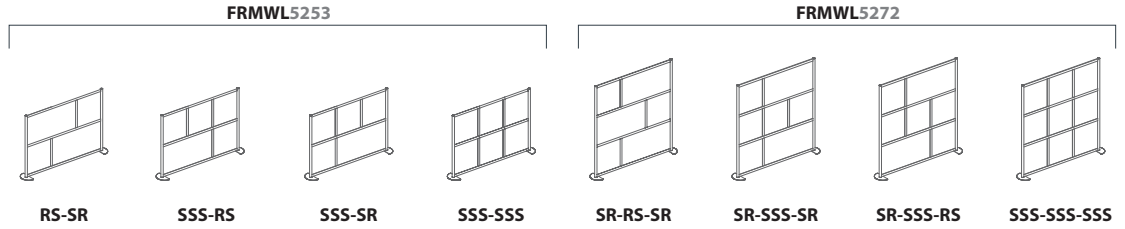

## 72" W

H	MODEL #	INFILL FINISHES		FRAME
		STANDARD	PREMIUM	BLACK/WHITE
53"	FRMWL7253-RS-SR	\$4,607	\$5,707	+ \$600
53"	FRMWL7253-SSS-RS	\$4,807	\$6,057	+ \$600
53"	FRMWL7253-SSS-SR	\$4,807	\$6,507	+ \$600
53"	FRMWL7253-SSS-SSS	\$5,157	\$6,407	+ \$600
72"	FRMWL7272-SR-RS-SR	\$5,907	\$7,607	+ \$600
72"	FRMWL7272-SR-SSS-SR	\$6,507	\$8,807	+ \$600
72"	FRMWL7272-SR-SSS-RS	\$6,207	\$7,957	+ \$600
72"	FRMWL7272-SSS-SSS-SSS	\$7,207	\$9,007	+ \$600

## Bases

DESCRIP	MODEL #	ANODIZED ALUMINUM	BLACK/WHITE
Half moon base	B01	\$90	\$117
12" Floor mount plate	B02	\$100	\$130
Caster base set	B03	\$200	\$260
12" Diameter link base	B04	\$100	\$130
Flush base	B05	\$220	\$286
6" Floor mount plate	B06	\$100	\$130
6" Non-floor mounted base	B07	\$100	\$130

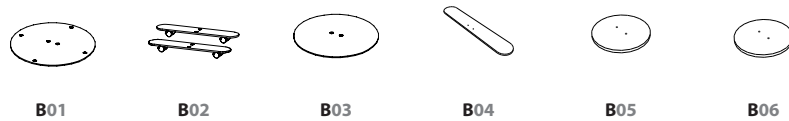

## INFILL FINISHES

### Standard

Solid Colors	Gr A	Translucent	Gr A	Acoustic	Gr A
White		Twinwall Clear Texture		Charcoal	
Black		Twinwall White		Cobalt	
Yellow		Twinwall Smoke		Cranberry	
Red		Frosted Acrylic		Marble	
Dark Gray		Clear Acrylic		Midnight	
Light Gray				Sand	
Blue				Sherbet	
				Shiitake	
				Snow	
				Steel	
				Pewter	

### Premium

Fabrics	Gr B	Laminate	Gr B
White		Madagascar	
Gray		Ebony	
Black		Zebrano	
Red		Asian Gray	
Blue		Maple	
Green		Cherry	
Orange		Dry Erase	
Camel		Magnetic Dry Erase	
Brown			

Free Standing

---

## STORAGE

---

Neutral Posture is not only dedicated to good posture, we are also dedicated to making offices more efficient and more enjoyable to work in. Neutral Posture knows that to increase efficiency in the office things must be organized well and be easily accessible. Neutral Posture offers the most space efficient and easily accessible products on the market.

Neutral Posture offers many diverse storage units making sure you can always find the exact unit of storage for your office's needs. From small pedestals that can double as seating to large towers with wardrobe capability, Neutral Posture can fit your needs in any situation. Along with our wide range of storage options, Neutral Posture also lets you truly personalize your office equipment, making your office a welcoming place for not only your customers, but, your employees as well.

Neutral Posture provides storage units that work together—meaning that they will work better for you and your workspace. Neutral Posture allows customization by offering several different color options, fabric patterns and even several different pulls and lock options to make sure your office space looks exactly how you want. Storage units that are cohesive have numerous benefits, such as taking up less space, being easier to access and making your office look more unified.

### TRUE DIMENSIONS

**Disclaimer:** While Equity panels and worksurfaces are based on centerline to centerline dimensions, all storage dimensions are true dimensions.



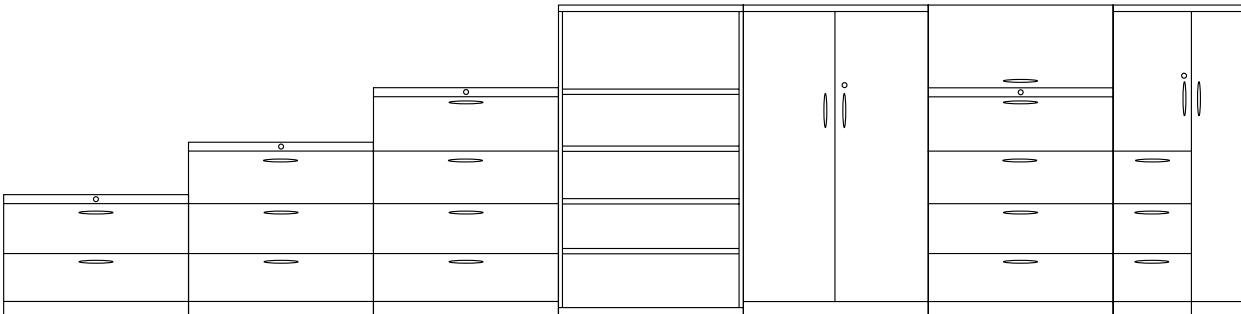





# STORAGE

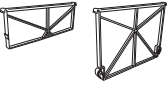





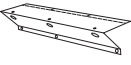

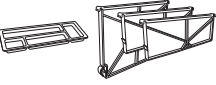
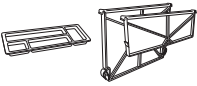

Storage

# Storage

## Accessories Availability

	PEDESTALS	LATERALS	TOWERS	CREDENZAS	CABINETS	LOCKERS	BOOKCASES
 Pencil tray	•	•	•				
 Drawer dividers	•		•				
 Magnetic label	•	•	•	•			
 Ped drawer front filler	•		•				
 Magnetic drawer dividers		•		•			
 Magnetic shelf divider			•	•	•		•
 Lateral file conversion bar		•					
 Worksurface supporting bracket			•				
 Ped accessory package – FF	•		•				
 Ped accessory package – BBF	•		•				
 Ped accessory package – BF	•						



	<b>MODEL #</b>	<b>LIST</b>
 Pencil tray	<b>SPTRY</b>	\$17
 6" Drawer divider	<b>SBDD</b>	\$17
 12" Drawer divider	<b>SFDD</b>	\$37
 Magnetic label	<b>SMLB</b>	\$67
 Ped drawer front filler	<b>SPFF</b>	\$66
 Magnetic drawer dividers	<b>SMDDB</b>	\$97
 Magnetic shelf divider	<b>SMSD</b>	\$77
 Lateral file conversion bar	<b>SLFCB</b>	\$77

**PED ACCESSORY PACKAGE – FF**

2 – 12" Drawer dividers	<b>SFFA</b>	\$67
-------------------------	-------------	------

**PED ACCESSORY PACKAGE – BBF**

2 – 6" Drawer dividers	<b>SBBFA</b>	\$77
1 – 12" Drawer dividers		
1 – Pencil tray		

**PED ACCESSORY PACKAGE – BF**

1 – 6" Drawer divider	<b>SBFA</b>	\$67
1 – 12" Drawer divider		
1 – Pencil tray		

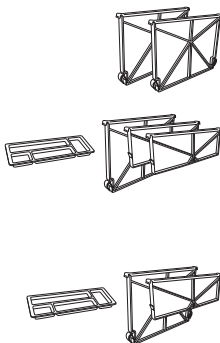

# Pedestals

## General Info

### Step 1 – Model #

Pedestal	Drawers	D	Pull
<b>SPED</b> Freestanding Pedestal	FF File File	<b>19</b>	J J Pull
SMPED Mobile Pedestal	<b>BBF</b> Box Box File		<b>B</b> Bar Pull
SCMPED Mobile Pedestal w/Cushion	BF Box File		R Radiused Pull
SSPED Suspended Pedestal			
SWSPED Worksurface Supporting Pedestal			
SWSLKR Worksurface Supporting Locker			
SFC File Center			
<b>SPED</b>	<b>BBF</b>	<b>19</b>	<b>B</b>

### Step 2 – Case Finish

Paints
<b>301</b> Champagne
<b>301</b>

### Step 3 – Front Finish

Not Available w/J Pull	
Laminate	
PW-STK	Studio Teak
<b>PW-STK</b>	

## FEATURES

### COUNTER WEIGHTS

- Freestanding, mobile and cushion pedestals include factory installed counterweights.
- Counterweights are not necessary for worksurface supporting or suspended pedestals.

### LOCK

- Lock core is removable.
- Keyed alike available upon request.
- Master and change key available upon request. See (page 9).
- Individual locking drawers available upon request. Upcharge may apply.

### DRAWERS

- Include full suspension steel ball-bearing slides.
- Drawer fronts include rubber bumpers for quiet operation.

### LEVELING GLIDES

4 Leveling glides allow for 1 5/8" adjustment.

### CASTERS – MOBILE PEDS

- 4 Black casters, 2 of which are locking.

## CONSTRUCTION

### OUTER SHELL & DRAWER CONSTRUCTION

Welded steel frame construction & formed channels ensure strength in key areas.

Top channels	18 – 21 Gauge
Side channels	18 – 21 Gauge
Outer panels	22 Gauge
Drawer fronts	20 Gauge
Drawer bins	22 Gauge

### DRAWER LOAD CAPACITY

6" Box drawers	50 lbs
12" File drawers	70 lbs

### DRAWER INNER DIMENSIONS

Height	
Box drawer	4 1/2"
File drawer	9 1/2"

### Width

All drawers	12 1/8"
-------------	---------

### Depth

18" Deep pedestal	15 1/5"
22" Deep pedestal	18 1/4"
30" Deep pedestal	24 1/4"

## PULL STYLES

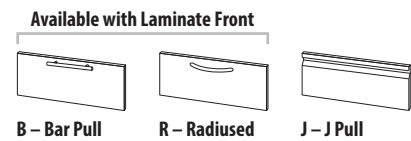

## SURFACE MATERIALS

### PEDESTAL

Paint

### FRONTS

w/Bar pull ( <b>B</b> )	Paint or Laminate
w/Radiused pull ( <b>R</b> )	Paint or Laminate
w/J pull ( <b>J</b> )	Paint

### DRAWER PULL

Bar ( <b>B</b> )	Satin nickel
Radiused ( <b>R</b> )	Satin nickel
J ( <b>J</b> )	Paint

### MOBILE PED HANDLE

Satin nickel

### LOCK

Satin nickel

### CUSHION TOP

Upholstery

# PEDESTALS

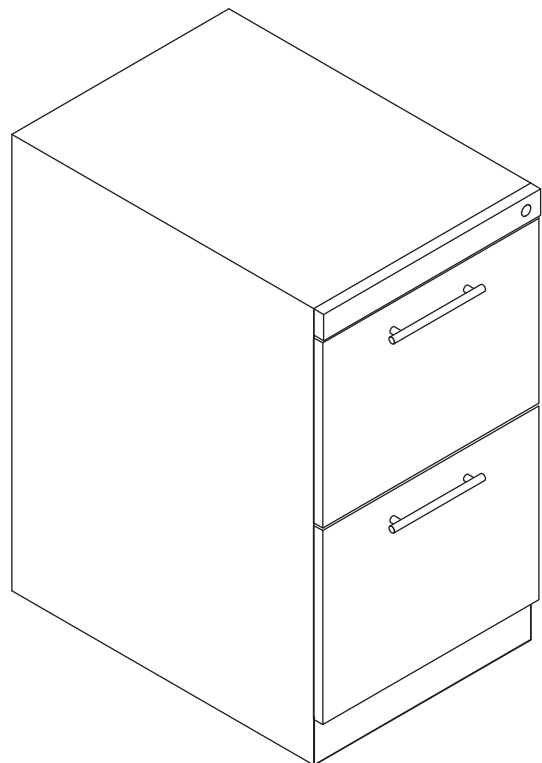

Storage

# Pedestals



## Freestanding

H	W	D	MODEL #	PAINT			LAMINATE FRONT (UPCHARGE)		
				P1	P2	P3	L1	L2	L3
27 3/4"	15 1/4"	21 7/8"	SPEDFF22(J/B/R)	\$597	\$657	\$716	+ \$260	+ \$286	+ \$312
27 3/4"	15 1/4"	21 7/8"	SPEDBBF22(J/B/R)	\$637	\$701	\$764	+ \$280	+ \$308	+ \$336
27 3/4"	15 1/4"	27 7/8"	SPEDFF30(J/B/R)	\$677	\$745	\$812	+ \$271	+ \$366	+ \$460
27 3/4"	15 1/4"	27 7/8"	SPEDBBF30(J/B/R)	\$697	\$767	\$836	+ \$279	+ \$376	+ \$474



## Mobile

H	W	D	MODEL #	PAINT			LAMINATE FRONT (UPCHARGE)		
				P1	P2	P3	L1	L2	L3
26 7/8"	15 1/4"	18 7/8"	SMPEDFF19(J/B/R)	\$597	\$657	\$716	+ \$260	+ \$286	+ \$312
26 7/8"	15 1/4"	18 7/8"	SMPEDBBF19(J/B/R)	\$647	\$712	\$776	+ \$285	+ \$314	+ \$342
21 7/8"	15 1/4"	18 7/8"	SMPEDBF19(J/B/R)	\$577	\$635	\$692	+ \$250	+ \$275	+ \$300
26 7/8"	15 1/4"	21 7/8"	SMPEDFF22(J/B/R)	\$637	\$701	\$764	+ \$280	+ \$308	+ \$336
26 7/8"	15 1/4"	21 7/8"	SMPEDBBF22(J/B/R)	\$677	\$745	\$812	+ \$300	+ \$330	+ \$360
21 7/8"	15 1/4"	21 7/8"	SMPEDBF22(J/B/R)	\$587	\$646	\$704	+ \$250	+ \$275	+ \$300
26 7/8"	15 1/4"	27 7/8"	SMPEDFF30(J/B/R)	\$657	\$723	\$788	+ \$263	+ \$355	+ \$447
26 7/8"	15 1/4"	27 7/8"	SMPEDBBF30(J/B/R)	\$687	\$756	\$824	+ \$275	+ \$371	+ \$467
21 7/8"	15 1/4"	27 7/8"	SMPEDBF30(J/B/R)	\$607	\$668	\$728	+ \$243	+ \$328	+ \$413



## Mobile Cushion

H	W	D	MODEL #	FABRIC							
				1	2	3	4	5	6	7	8
1"	15 1/4"	18 7/8"	PC19	\$180	\$210	\$240	\$270	\$340	\$400	\$460	\$550
1"	15 1/4"	21 7/8"	PC22	\$180	\$210	\$240	\$270	\$340	\$400	\$460	\$550
1"	15 1/4"	27 7/8"	PC30	\$180	\$210	\$240	\$270	\$340	\$400	\$460	\$550

### Specify

1. Model #
2. Case finish
3. Front finish  
*Laminate not available on J pull*

### Pulls

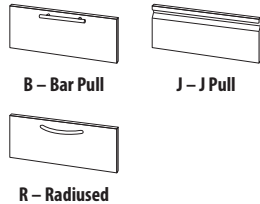

### Ordered Separately

- Pencil tray

### Freestanding Peds

- Included**
- Counterweight for stability
  - Leveling glides allow for 1/8" adjustment

### Mobile Peds

- Included**
- Counterweight for stability
  - Black 37mm plastic casters (2 locking & 2 non-locking)

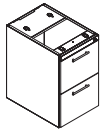

## Suspended

H	W	D	MODEL #	PAINT			LAMINATE FRONT (UPCHARGE)		
				P1	P2	P3	L1	L2	L3
25"	15 1/4"	21 7/8"	SSPEDFF22(J/B/R)	\$597	\$657	\$716	+ \$260	+ \$286	+ \$312
25"	15 1/4"	21 7/8"	SSPEDBBF22(J/B/R)	\$637	\$701	\$764	+ \$280	+ \$308	+ \$336
19 3/8"	15 1/4"	21 7/8"	SSPEDBF22(J/B/R)	\$497	\$547	\$596	+ \$215	+ \$237	+ \$258



## Worksurface Supporting

H	W	D	MODEL #	P1	P2	P3	L1	L2	L3
27 3/4"	15 1/4"	17 7/8"	SWSPEDFF18(J/B/R)	\$577	\$635	\$692	+ \$255	+ \$281	+ \$306
27 3/4"	15 1/4"	17 7/8"	SWSPEDBBF18(J/B/R)	\$617	\$679	\$740	+ \$270	+ \$297	+ \$324
27 3/4"	15 1/4"	21 7/8"	SWSPEDFF22(J/B/R)	\$577	\$635	\$692	+ \$255	+ \$281	+ \$306
27 3/4"	15 1/4"	21 7/8"	SWSPEDBBF22(J/B/R)	\$617	\$679	\$740	+ \$270	+ \$297	+ \$324
27 3/4"	15 1/4"	27 7/8"	SWSPEDFF30(J/B/R)	\$597	\$657	\$716	+ \$239	+ \$322	+ \$406
27 3/4"	15 1/4"	27 7/8"	SWSPEDBBF30(J/B/R)	\$657	\$723	\$788	+ \$263	+ \$355	+ \$447

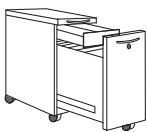

## Mobile Slim

DRAWER ACCESS	H	W	D	MODEL #	PAINT			LAMINATE FRONT (UPCHARGE)		
					P1	P2	P3	L1	L2	L3
L	20"	12"	18 7/8"	SMPEDSLM19L(J/B/R)	\$1,097	\$1,207	\$1,316	+ \$280	+ \$308	+ \$336
R	20"	12"	18 7/8"	SMPEDSLM19R(J/B/R)	\$1,097	\$1,207	\$1,316	+ \$280	+ \$308	+ \$336
Both	20"	12"	18 7/8"	SMPEDSLM19B(J/B/R)	\$1,147	\$1,262	\$1,376	+ \$280	+ \$308	+ \$336



## Mobile Slim Cushion

H	W	D	MODEL #	FABRIC							
				1	2	3	4	5	6	7	8
1"	12"	18 7/8"	PCS19	\$180	\$210	\$240	\$270	\$340	\$400	\$460	\$550

### Specify

1. Model #
2. Case finish
3. Front finish  
*Laminate not available on J Pull*

Lateral		W	Pull	Options	
SPED Freestanding Pedestal	FF File File	19	J J Pull	DL Digital Lock	\$357
SMPED Mobile Pedestal	BBF Box Box File		B Bar Pull		
SCMPED Mobile Pedestal w/Cushion	BF Box File		R Radiused Pull		
SSPED Suspended Pedestal					
SWSPED Worksurface Supporting Pedestal					
SWSLKR Worksurface Supporting Locker					
SFC File Center					
<b>SPED</b>	<b>BBF</b>	<b>19</b>	<b>B</b>	<b>DL</b>	

# File Centers

## General Info

### Step 1 – Model #

File Center	Drawers	D	Pull
<b>SFC</b> <b>File Center</b>	FF File File	<b>19</b>	J J Pull
SCFC Freestanding File Center w/cushion	<b>BBF</b> <b>Box Box File</b>		<b>B</b> <b>Bar Pull</b>
SCMFC Mobile File Center w/cushion	BF Box File		R Radiused Pull
<b>SFC</b>	<b>BBF</b>	<b>19</b>	<b>B</b>

### Step 2 – Case Finish

Paints
<b>301</b> <b>Champagne</b>
<b>301</b>

### Step 3 – Front Finish

Not Available w/J Pull	
Laminate	
PW-STK	Studio Teak
<b>PW-STK</b>	

## FEATURES

### COUNTER WEIGHTS

- Freestanding file centers include factory installed counterweights.
- Counterweights are not necessary for worksurface supporting file centers.

### LOCK

- Lock core is removable.
- Keyed alike available upon request.
- Master and change key available upon request. See (page 9).
- Individual locking drawers available upon request. Upcharge may apply.

### DRAWERS

- Include full suspension steel ball-bearing slides.
- Drawer fronts include rubber bumpers for quiet operation.

### LEVELING GLIDES

4 Leveling glides allow for 1 5/8" adjustment.

### CASTERS – MOBILE PEDS

- 4 Black casters, 2 of which are locking

## CONSTRUCTION

### OUTER SHELL & DRAWER CONSTRUCTION

Welded steel frame construction & formed channels ensure strength in key areas.

Top channels	18 – 21 Gauge
Side channels	18 – 21 Gauge
Outer panels	22 Gauge
Drawer fronts	20 Gauge
Drawer bins	22 Gauge

### DRAWER LOAD CAPACITY

6" Box drawers	50 lbs
12" File drawers	70 lbs

### DRAWER INNER DIMENSIONS

Height	
Box drawer	4 1/2"
File drawer	9 1/2"

### Width

All drawers	12 1/8"
-------------	---------

### Depth

18" Deep pedestal	15 1/5"
30" Deep pedestal	26 1/4"

## PULL STYLES

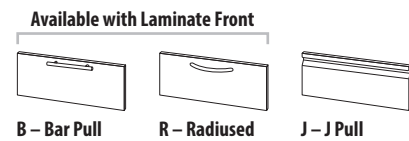

## SURFACE MATERIALS

### PEDESTAL

Paint

### FRONTS

w/Bar pull ( <b>B</b> )	Paint or Laminate
w/Radiused pull ( <b>R</b> )	Paint or Laminate
w/J pull ( <b>J</b> )	Paint

### DRAWER PULL

Bar ( <b>B</b> )	Satin nickel
Radiused ( <b>R</b> )	Satin nickel
J ( <b>J</b> )	Paint

### LOCK

Satin nickel

### CUSHION TOP

Upholstery

# FILE CENTERS

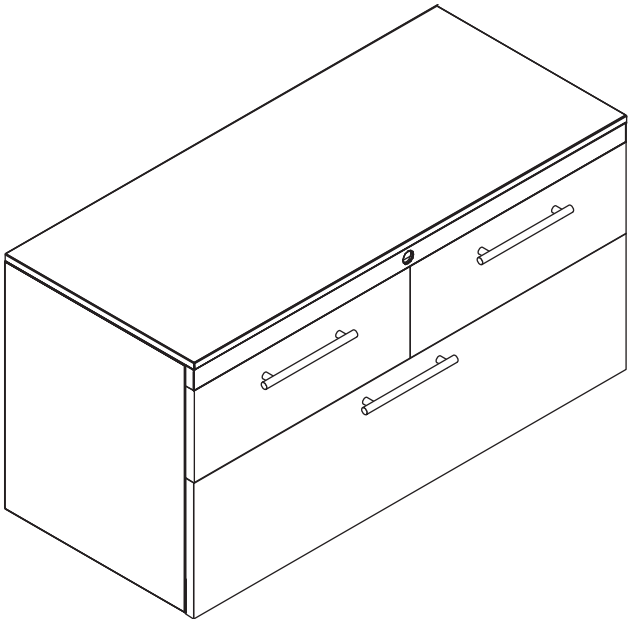

Storage

# File Centers



## Worksurface Supporting File Center

H	W	D	MODEL #	PAINT			LAMINATE FRONT (UPCHARGE)		
				P1	P2	P3	L1	L2	L3
27 3/4"	30 1/2"	18 1/4"	SFCFFLAT(J/B)	\$1,177	\$1,295	\$1,412	+ \$520	+ \$572	+ \$624
27 3/4"	30 1/2"	18 1/4"	SFCBBFLAT(J/B)	\$1,187	\$1,306	\$1,424	+ \$540	+ \$594	+ \$648
27 3/4"	30 1/2"	18 1/4"	SFCFBBLAT(J/B)	\$1,187	\$1,306	\$1,424	+ \$540	+ \$594	+ \$648



## Mobile File Center w/cushion

H	W	D	MODEL #	P1	P2	P3	L1	L2	L3
24 1/8"	30 1/2"	18 3/8"	SCMFCBBLAT(J/B)	\$2,007	\$2,208	\$2,408	+ \$700	+ \$971	+ \$1,241

## Mobile Cushion Fabric Upcharges

SEATING GRADES	UPCHARGE
1	+ \$225
2	+ \$300
3	+ \$400
4	+ \$500
5	+ \$600
6	+ \$700
7	+ \$800
8	+ \$900

### Specify

1. Model #
2. Case finish
3. Front finish  
*Laminate not available on J pull*

### Pulls



B – Bar Pull

J – J Pull



R – Radiused

### Ordered Separately

- Pencil tray

### Freestanding File Center

- Included**
- Counterweight for stability
  - Leveling glides allow for 1 3/8" adjustment

### Mobile File Center

- Included**
- Counterweight for stability
  - Black 37mm plastic casters (2 locking & 2 non-locking)
  - 1" cushion in black  
*Other fabrics available for an upcharge.*





## Mobile File Center w/Cupboard Door

HINGE	H	W	D	MODEL #	PAINT			LAMINATE FRONT (UPCHARGE)		
					P1	P2	P3	L1	L2	L3
L	22 3/8"	30 1/2"	18 1/4"	SMFCFBCUBL(J/B)	\$1,247	\$1,347	\$1,447	+\$540	+\$594	+\$648
R	22 3/8"	30 1/2"	18 1/4"	SMFCFBCUBR(J/B)	\$1,247	\$1,347	\$1,447	+\$540	+\$594	+\$648



## Mobile File Center w/Open Shelf

HINGE	H	W	D	MODEL #	P1	P2	P3	L1	L2	L3
R	22 3/8"	30 1/2"	18 1/4"	SMFCFBSHFR(J/B)	\$1,147	\$1,347	\$1,447	+\$530	+\$583	+\$636



## Mobile File Center Cushion

H	W	D	MODEL #	FABRIC							
				A/1	B/2	C/3	D/4	E/5	F/6	G/7	H/8
1"	30 1/2"	18 1/4"	MFCC30	\$327	\$427	\$477	\$527	\$577	\$627	\$677	\$747

### Specify

1. Model #
2. Case finish
3. Front finish  
*Laminate not available on J Pull*

Lateral				W	Pull	Options	
<b>SFC</b>	<b>File Center</b>	FF File File	<b>19</b>	J J Pull	<b>DL</b>	<b>Digital Lock</b>	<b>\$357</b>
SCFC	Freestanding File Center w/cushion	<b>BBF</b> <b>Box Box File</b>		<b>B</b> <b>Bar Pull</b>			
SCMFC	Mobile File Center w/cushion	BF Box File		R Radiused Pull			
<b>SFC</b>		<b>BBF</b>	<b>19</b>	<b>B</b>	<b>DL</b>		

# Laterals

## General Info

### Step 1 – Model #

Lateral	# of Drawers	W	Pull
SLAT Lateral SWSLAT Worksurface Supporting	3	36	J J Pull B Bar Pull
SLAT	3	36	B

### Step 2 – Case Finish

Paint
301 Champagne
301

### Step 3 – Front Finish

Not Available w/J Pull	
Laminate	
PW-STK	Studio Teak
PW-STK	

## FEATURES

### COUNTER WEIGHTS

- Counterweights are not included with laterals.
- Counterweights are not necessary for worksurface supporting laterals.

### LOCK

- Lock core is removable.
- Keyed alike available upon request.
- Master and change key available upon request. See (page 9).
- Individual locking drawers available upon request. Upcharge may apply.

### DRAWERS

- All drawers include full extension steel ball-bearing slides with anti-rebound features to ensure smooth operation.
- Drawer fronts include rubber bumpers for quiet operation.
- The top opening of 5-high laterals features an over-the-top flipper door with 13 ¼" inside clear height for binder storage.
- Drawer includes full-height side panels.
- 2 file bars are included in each drawer, for side-to-side filing.
- Conversion bars for front to back filing are sold separately.
- All lateral drawer bins will accommodate A4, letter and legal size filing.

### LEVELING GLIDES

4 leveling glides allow for 1 ¼" adjustment.

### COUNTERWEIGHTS

Counterweights are required for all lateral files that are not ganged together or otherwise anchored.

## CONSTRUCTION

### OUTER SHELL & DRAWER CONSTRUCTION

Welded steel frame construction & formed channels ensure strength in key areas. Standard depth is 18 ¼".

Inner frame	20 Gauge
Outer panels	22 Gauge
Drawer fronts	20 Gauge
Drawer bins	20 Gauge

### DRAWER LOAD CAPACITY

30" Wide lateral	140 lbs
36" Wide lateral	168 lbs
42" Wide lateral	192 lbs

### DRAWER INNER DIMENSIONS

#### Height

Top flipper door	13 ¼"
Drawer immediately below lock strip	9 ½"
All other drawers	10 ¾"

#### Width

30" Wide lateral	26 ⅞"
36" Wide lateral	32 ⅞"
42" Wide lateral	38 ⅞"

#### Depth

18 ¼" Deep lateral	16"
--------------------	-----

## PULL STYLES

Available with Laminate Front



B – Bar Pull



J – J Pull

## SURFACE MATERIALS

### LATERAL

Paint

### FRONTS

w/Bar pull (B)	Paint or Laminate
w/J pull (J)	Paint

### DRAWER PULL

Bar (B)	Satin nickel
J (J)	Paint

### LOCK

Satin nickel

### TOP

Paint or Laminate

# LATERALS

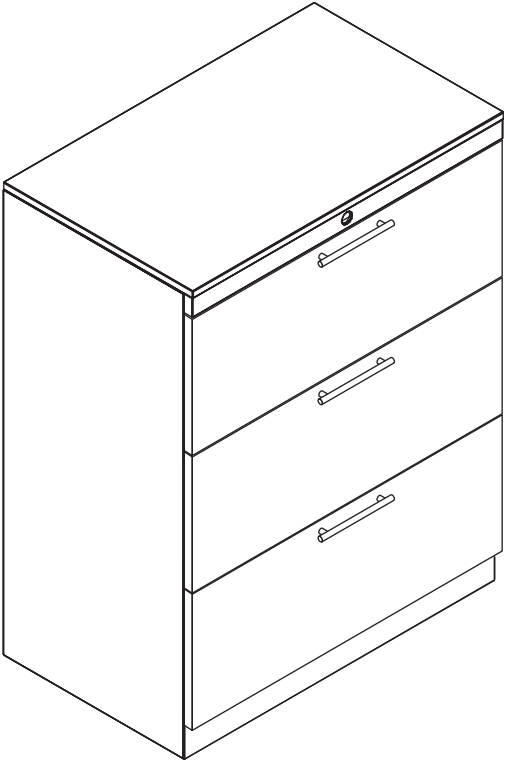

Storage

# Laterals



## 2 Drawer

H	W	D	MODEL #	PAINT			LAMINATE FRONT (UPCHARGE)		
				P1	P2	P3	L1	L2	L3
28 3/8"	30"	18 1/4"	SLAT230(J/B)	\$897	\$987	\$1,076	+ \$400	+ \$440	+ \$528
28 3/8"	36"	18 1/4"	SLAT236(J/B)	\$1,097	\$1,207	\$1,316	+ \$440	+ \$484	+ \$581
28 3/8"	42"	18 1/4"	SLAT242(J/B)	\$1,147	\$1,262	\$1,376	+ \$480	+ \$528	+ \$634

Counterweights are required for all lateral files that are not ganged together or otherwise anchored.



## 3 Drawer

H	W	D	MODEL #	P1	P2	P3	L1	L2	L3
39 7/8"	30"	18 1/4"	SLAT330(J/B)	\$1,247	\$1,372	\$1,496	+ \$550	+ \$605	+ \$726
39 7/8"	36"	18 1/4"	SLAT336(J/B)	\$1,397	\$1,537	\$1,676	+ \$590	+ \$649	+ \$779
39 7/8"	42"	18 1/4"	SLAT342(J/B)	\$1,497	\$1,647	\$1,796	+ \$630	+ \$693	+ \$832

Counterweights are required for all lateral files that are not ganged together or otherwise anchored.



## 4 Drawer

H	W	D	MODEL #	P1	P2	P3	L1	L2	L3
51 3/8"	30"	18 1/4"	SLAT430(J/B)	\$1,547	\$1,702	\$1,856	+ \$670	+ \$737	+ \$884
51 3/8"	36"	18 1/4"	SLAT436(J/B)	\$1,697	\$1,867	\$2,036	+ \$700	+ \$770	+ \$924
51 3/8"	42"	18 1/4"	SLAT442(J/B)	\$1,797	\$1,977	\$2,156	+ \$730	+ \$803	+ \$964

Counterweights are required for all lateral files that are not ganged together or otherwise anchored.

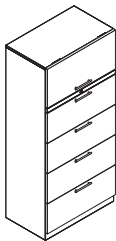

## 5 Drawer — fixed top shelf

H	W	D	MODEL #	P1	P2	P3	L1	L2	L3
65 7/8"	30"	18 1/4"	SLAT530(J/B)	\$1,847	\$2,032	\$2,216	+ \$740	+ \$814	+ \$977
65 7/8"	36"	18 1/4"	SLAT536(J/B)	\$1,997	\$2,197	\$2,396	+ \$760	+ \$836	+ \$1,003
65 7/8"	42"	18 1/4"	SLAT542(J/B)	\$2,197	\$2,417	\$2,636	+ \$780	+ \$858	+ \$1,030

Counterweights are required for all lateral files that are not ganged together or otherwise anchored.

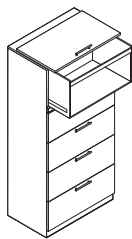

## 5 Drawer — w/roll-out shelf

H	W	D	MODEL #	P1	P2	P3	L1	L2	L3
65 7/8"	30"	18 1/4"	SLAT5R30(J/B)	\$2,777	\$3,055	\$3,332	+ \$2,000	+ \$2,200	+ \$2,400
65 7/8"	36"	18 1/4"	SLAT5R36(J/B)	\$3,177	\$3,495	\$3,812	+ \$2,000	+ \$2,200	+ \$2,400
65 7/8"	42"	18 1/4"	SLAT5R42(J/B)	\$3,377	\$3,715	\$4,052	+ \$2,000	+ \$2,200	+ \$2,400

Counterweights are required for all lateral files that are not ganged together or otherwise anchored.

### Specify

1. Model #
2. Case finish
3. Front finish  
*Laminate not available on J pull*

### Application Notes

- Included**
- Leveling glides for 1 3/8" adjustment

### Pulls

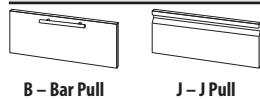

B – Bar Pull

J – J Pull

Lateral	# Drawers	W	Pull	Options		
SLAT Lateral	2	36	J J Pull	CW	Counterweights	\$167
SWSLAT Worksurface Supporting	3		B Bar Pull	DL	Digital Lock	\$357
	4					
	5					
SLAT	3	36	J	CW		

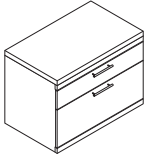

BF				PAINT			LAMINATE FRONT (UPCHARGE)		
H	W	D	MODEL #	P1	P2	P3	L1	L2	L3
22 3/8"	30"	18 1/4"	SLAT130(J/B)	\$1,007	\$1,108	\$1,208	+ \$350	+ \$486	+ \$621
22 3/8"	36"	18 1/4"	SLAT136(J/B)	\$1,107	\$1,218	\$1,328	+ \$350	+ \$496	+ \$641
22 3/8"	42"	18 1/4"	SLAT142(J/B)	\$1,207	\$1,328	\$1,448	+ \$350	+ \$506	+ \$661

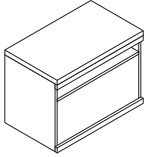

BF Shelf				PAINT			LAMINATE FRONT (UPCHARGE)		
H	W	D	MODEL #	P1	P2	P3	L1	L2	L3
22 3/8"	30"	18 1/4"	SLATS130	\$807	\$888	\$968	N/A	N/A	N/A
22 3/8"	36"	18 1/4"	SLATS136	\$907	\$998	\$1,088	N/A	N/A	N/A
22 3/8"	42"	18 1/4"	SLATS142	\$1,007	\$1,108	\$1,208	N/A	N/A	N/A

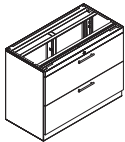

Worksurface Supporting				PAINT			LAMINATE FRONT (UPCHARGE)		
H	W	D	MODEL #	P1	P2	P3	L1	L2	L3
27 3/4"	30"	18 1/4"	SWSLAT230(J/B)	\$897	\$987	\$1,076	+ \$400	+ \$440	+ \$528
27 3/4"	36"	18 1/4"	SWSLAT236(J/B)	\$997	\$1,097	\$1,196	+ \$440	+ \$484	+ \$581
27 3/4"	42"	18 1/4"	SWSLAT242(J/B)	\$1,097	\$1,207	\$1,316	+ \$480	+ \$528	+ \$634

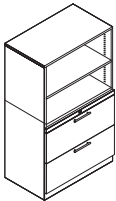

2 Drawer/2 Open Shelves				PAINT			LAMINATE FRONT (UPCHARGE)		
H	W	D	MODEL #	P1	P2	P3	L1	L2	L3
51 3/8"	30"	18 1/4"	SLAT2S2F30(J/B)	\$2,207	\$2,428	\$2,648	+ \$2,000	+ \$2,200	+ \$2,400
52 3/8"	36"	18 1/4"	SLAT2S2F36(J/B)	\$2,507	\$2,758	\$3,008	+ \$2,000	+ \$2,200	+ \$2,400
53 3/8"	42"	18 1/4"	SLAT2S2F42(J/B)	\$2,957	\$3,253	\$3,548	+ \$2,000	+ \$2,200	+ \$2,400

Counterweights are required for all lateral files that are not ganged together or otherwise anchored.

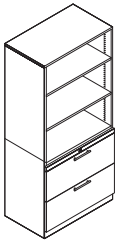

2 Drawer/3 Open Shelves				PAINT			LAMINATE FRONT (UPCHARGE)		
H	W	D	MODEL #	P1	P2	P3	L1	L2	L3
65 7/8"	30"	18 1/4"	SLAT3S2F30(J/B)	\$2,307	\$2,538	\$2,768	+ \$2,000	+ \$2,200	+ \$2,400
65 7/8"	36"	18 1/4"	SLAT3S2F36(J/B)	\$2,607	\$2,868	\$3,128	+ \$2,000	+ \$2,200	+ \$2,400
65 7/8"	42"	18 1/4"	SLAT3S2F42(J/B)	\$3,057	\$3,363	\$3,668	+ \$2,000	+ \$2,200	+ \$2,400

Counterweights are required for all lateral files that are not ganged together or otherwise anchored.

## Lateral – Accessories

DESCRIPTION	MODEL #	BLACK ONLY
Lateral ganging kit	SLATGK	\$147

### Specify

1. Model #
2. Case finish
3. Front finish  
*Laminate not available on J pull*

Lateral			W	Pull	Options	
SLAT1	BF Lateral w/Metal Top	36	J J Pull B Bar Pull	CW Counterweights DL Digital Lock	\$167 \$357	
SLAT1		36	J	CW		

# Laterals



## 6B Drawer

H	W	D	MODEL #	PAINT		
				P1	P2	P3
39 7/8"	30"	18 1/4"	S6BLAT30(J/B)	\$1,877	\$2,065	\$2,252
39 7/8"	36"	18 1/4"	S6BLAT36(J/B)	\$1,977	\$2,175	\$2,372
39 7/8"	42"	18 1/4"	S6BLAT42(J/B)	\$2,157	\$2,373	\$2,588

Counterweights are required for all lateral files that are not ganged together or otherwise anchored.

## 6B Drawer, No Top

39 7/8"	30"	18 1/4"	S6BLAT30NT(J/B)	\$1,807	\$1,988	\$2,168
39 7/8"	36"	18 1/4"	S6BLAT36NT(J/B)	\$1,907	\$2,098	\$2,288
39 7/8"	42"	18 1/4"	S6BLAT42NT(J/B)	\$2,107	\$2,318	\$2,528

Counterweights are required for all lateral files that are not ganged together or otherwise anchored.

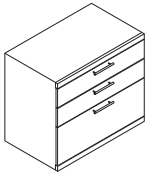

## BBF Drawer

28 3/8"	30"	18 1/4"	S2BFLAT30(J/B)	\$1,207	\$1,328	\$1,448
28 3/8"	36"	18 1/4"	S2BFLAT36(J/B)	\$1,307	\$1,438	\$1,568
28 3/8"	42"	18 1/4"	S2BFLAT42(J/B)	\$1,407	\$1,548	\$1,688

Counterweights are required for all lateral files that are not ganged together or otherwise anchored.

## BBF Drawer, No Top

28 3/8"	30"	18 1/4"	S2BFLAT30NT(J/B)	\$1,207	\$1,328	\$1,448
28 3/8"	36"	18 1/4"	S2BFLAT36NT(J/B)	\$1,307	\$1,438	\$1,568
28 3/8"	42"	18 1/4"	S2BFLAT42NT(J/B)	\$1,407	\$1,548	\$1,688

Counterweights are required for all lateral files that are not ganged together or otherwise anchored.

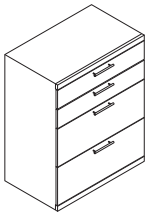

## BBFF Drawer

39 7/8"	30"	18 1/4"	S2B2FLAT30(J/B)	\$1,607	\$1,768	\$1,928
39 7/8"	36"	18 1/4"	S2B2FLAT36(J/B)	\$1,707	\$1,878	\$2,048
39 7/8"	42"	18 1/4"	S2B2FLAT42(J/B)	\$1,807	\$1,988	\$2,168

Counterweights are required for all lateral files that are not ganged together or otherwise anchored.

## BBFF Drawer, No Top

39 7/8"	30"	18 1/4"	S2B2FLAT30NT(J/B)	\$1,607	\$1,768	\$1,928
39 7/8"	36"	18 1/4"	S2B2FLAT36NT(J/B)	\$1,707	\$1,878	\$2,048
39 7/8"	42"	18 1/4"	S2B2FLAT42NT(J/B)	\$1,807	\$1,988	\$2,168

Counterweights are required for all lateral files that are not ganged together or otherwise anchored.

### Specify

1. Model #
2. Case finish

Lateral		W	Pull	Options	
S6BLAT	6B Drawer Lat	36	J J Pull	CW	Counterweights \$167
S2BFLAT	BBF Drawer Lat		B Bar Pull	DL	Digital Lock \$357
S2B2FLAT	BBFF Drawer Lat				
S6BLAT		36	J	CW	

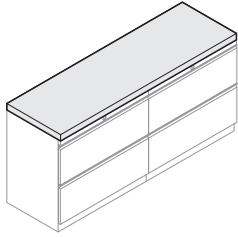

**Common Top – 18" Deep**

H	W	D	MODEL #	LAMINATE		
				L1	L2	L3
5/8"	30"	18 1/4"	LT30	\$350	\$385	\$420
5/8"	36"	18 1/4"	LT36	\$380	\$418	\$456
5/8"	42"	18 1/4"	LT42	\$390	\$429	\$468
5/8"	60"	18 1/4"	LT60	\$410	\$451	\$492
5/8"	66"	18 1/4"	LT66	\$465	\$512	\$558
5/8"	72"	18 1/4"	LT72	\$485	\$534	\$582
5/8"	84"	18 1/4"	LT84	\$490	\$539	\$588
5/8"	90"	18 1/4"	LT90	\$495	\$545	\$594
5/8"	108"	18 1/4"	LT108	\$530	\$583	\$636
5/8"	126"	18 1/4"	LT126	\$705	\$776	\$846

**Common Top – 36" Deep**

5/8"	30"	36 1/2"	LT3037	\$500	\$550	\$600
5/8"	36"	36 1/2"	LT3637	\$550	\$605	\$660
5/8"	42"	36 1/2"	LT4237	\$625	\$688	\$750
5/8"	60"	36 1/2"	LT6037	\$725	\$798	\$870
5/8"	66"	36 1/2"	LT6637	\$800	\$880	\$960
5/8"	72"	36 1/2"	LT7237	\$850	\$935	\$1,020
5/8"	84"	36 1/2"	LT8437	\$900	\$990	\$1,080
5/8"	90"	36 1/2"	LT9037	\$950	\$1,045	\$1,140
5/8"	108"	36 1/2"	LT10837	\$1,150	\$1,265	\$1,380
5/8"	126"	36 1/2"	LT12637	\$1,250	\$1,375	\$1,500

**Specify**

1. Model #
2. Laminate
3. Edge band

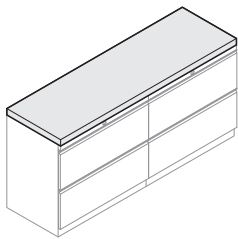

**Cushion – 18" Deep**

H	W	D	MODEL #	FABRIC							
				A/1	B/2	C/3	D/4	E/5	F/6	G/7	H/8
1"	30"	18 1/4"	LC30	\$327	\$427	\$477	\$527	\$577	\$627	\$677	\$747
1"	36"	18 1/4"	LC36	\$352	\$452	\$507	\$557	\$617	\$682	\$747	\$837
1"	42"	18 1/4"	LC42	\$377	\$477	\$537	\$587	\$657	\$737	\$817	\$927
1"	60"	18 1/4"	LC60	\$437	\$537	\$607	\$667	\$757	\$857	\$957	\$1,107
1"	66"	18 1/4"	LC66	\$462	\$562	\$637	\$697	\$802	\$912	\$1,027	\$1,187
1"	72"	18 1/4"	LC72	\$487	\$587	\$667	\$727	\$847	\$967	\$1,097	\$1,267
1"	84"	18 1/4"	LC84	\$527	\$627	\$717	\$787	\$927	\$1,067	\$1,237	\$1,387
1"	90"	18 1/4"	LC90	\$557	\$657	\$747	\$817	\$977	\$1,127	\$1,317	\$1,467
1"	108"	18 1/4"	LC108	\$617	\$717	\$817	\$897	\$1,077	\$1,252	\$1,447	\$1,627
1"	126"	18 1/4"	LC126	\$677	\$777	\$887	\$977	\$1,177	\$1,377	\$1,577	\$1,787

**Cushion – 36" Deep**

1"	30"	36 1/2"	LC3037	\$477	\$537	\$597	\$697	\$797	\$897	\$997	\$1,097
1"	36"	36 1/2"	LC3637	\$507	\$577	\$642	\$757	\$872	\$992	\$1,112	\$1,257
1"	42"	36 1/2"	LC4237	\$537	\$617	\$687	\$817	\$947	\$1,087	\$1,227	\$1,417
1"	60"	36 1/2"	LC6037	\$607	\$707	\$797	\$937	\$1,107	\$1,297	\$1,497	\$1,807
1"	66"	36 1/2"	LC6637	\$637	\$737	\$837	\$987	\$1,177	\$1,382	\$1,607	\$1,947
1"	72"	36 1/2"	LC7237	\$667	\$767	\$877	\$1,037	\$1,247	\$1,467	\$1,717	\$2,087
1"	84"	36 1/2"	LC8437	\$727	\$827	\$957	\$1,127	\$1,367	\$1,617	\$1,897	\$2,297
1"	90"	36 1/2"	LC9037	\$757	\$857	\$997	\$1,177	\$1,437	\$1,717	\$2,017	\$2,437
1"	108"	36 1/2"	LC10837	\$837	\$942	\$1,097	\$1,287	\$1,567	\$1,907	\$2,257	\$2,717
1"	126"	36 1/2"	LC12637	\$917	\$1,027	\$1,197	\$1,397	\$1,697	\$2,097	\$2,497	\$2,997

**Specify**

1. Model #
2. Fabric

# Towers

## General Info

### Step 1 – Model #

	H	W	Drawers	Coat Door	Pull
STWR Tower	56	22	FF BBF	L Left R Right	J J Pull B Bar Pull R Radiused Pull
<b>STWR</b>	<b>56</b>	<b>22</b>	<b>FF</b>	<b>L</b>	<b>B</b>

### Step 2 – Case Finish

Paint
301 Champagne
<b>301</b>

### Step 3 – Front Finish

Not Available w/J Pull	
Laminate	
PW-STK	Studio Teak
<b>PW-STK</b>	

## FEATURES

### LOCK

- Lock core is removable.
- 24" Side access tower includes 2 locks. All others include 1 lock.
- Keyed alike available upon request.
- Master and change key available upon request. See (page 9).
- Individual locking drawers available upon request. Upcharge may apply.

### DRAWERS

- Include full suspension steel ball-bearing slides.
- Drawer fronts include rubber bumpers for quiet operation.
- Slides include anti-rebound and quick disconnect features.
- File drawer dividers which allow side-to-side filing are sold separately.

### SHELVES

Shelves are adjustable in 1 ½" increments.

### LEVELING GLIDES – TOWER

Leveling glides allow for 7/8" adjustment.

### LEVELING GLIDES – SIDE ACCESS TOWER

Leveling glides allow for 1 5/8" adjustment.

### DOORS

Cupboard and coat doors include concealed hinges that allow for 110° degree opening.

## CONSTRUCTION

### OUTER SHELL & DRAWER CONSTRUCTION

Welded steel frame construction & formed channels ensure strength in key areas.

Inner top channel	18 Gauge
Bottom channel	18 Gauge
Side channels	18 Gauge
Outer top	21 Gauge
Outer back	21 Gauge
Outer sides	21 Gauge
Outer center	21 Gauge
Drawer & door fronts	21 Gauge
Shelves	18 Gauge
Drawer bins	22 Gauge
Drawer fronts	20 Gauge

### DRAWER LOAD CAPACITY

6" Box drawers	50 lbs
12" File drawers	70 lbs

### SHELF LOAD CAPACITY

Shelf	61 lbs
-------	--------

### DRAWER INNER DIMENSIONS

#### Height

Box drawer	4 ½"
File drawer	9 ½"

#### Width

All drawers	12 ½"
-------------	-------

#### Depth

All drawers	18 ¼"
-------------	-------

## PULL STYLES

Available with Laminate Front



## SURFACE MATERIALS

### CASE

Paint

### FRONTS

w/Bar Pull (B)	Paint or Laminate
w/Radiused Pull (R)	Paint or Laminate
w/J Pull (J)	Paint

**NOTE: Laminate is not available on 24" side access towers, 15" towers or 15" side access towers.**

### DRAWER PULL

Bar (B)	Satin nickel
Radiused (R)	Satin nickel
J (J)	Paint

### LOCK

Satin nickel



# TOWERS

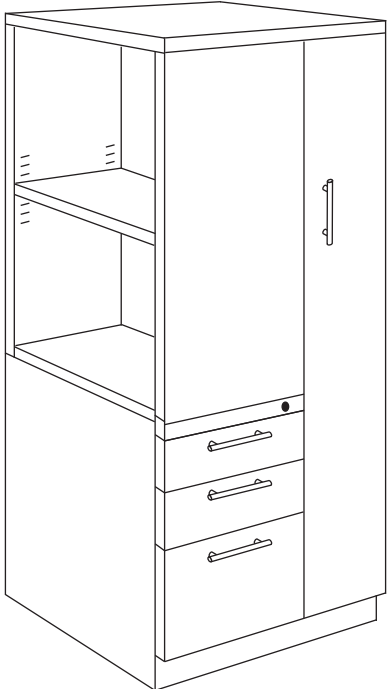

Storage

# Towers

24" Wide



STWR5624BBFLB

## 46" High — does not include an adj. shelf

COAT DOOR	H	W	D	MODEL #	PAINT			LAMINATE FRONT (UPCHARGE)		
					P1	P2	P3	L1	L2	L3
L	46"	23 1/2"	23 1/2"	STWR4624FFL(J/B/R)	\$2,097	\$2,307	\$2,516	+ \$920	+ \$1,012	+ \$1,104
R	46"	23 1/2"	23 1/2"	STWR4624FFR(J/B/R)	\$2,097	\$2,307	\$2,516	+ \$920	+ \$1,012	+ \$1,104
L	46"	23 1/2"	23 1/2"	STWR4624BBFL(J/B/R)	\$2,147	\$2,362	\$2,576	+ \$950	+ \$1,045	+ \$1,140
R	46"	23 1/2"	23 1/2"	STWR4624BBFR(J/B/R)	\$2,147	\$2,362	\$2,576	+ \$950	+ \$1,045	+ \$1,140

## 51" High — includes 1 adj. shelf

L	51 3/8"	23 1/2"	23 1/2"	STWR5124FFL(J/B/R)	\$2,147	\$2,362	\$2,576	+ \$950	+ \$1,045	+ \$1,140
R	51 3/8"	23 1/2"	23 1/2"	STWR5124FFR(J/B/R)	\$2,147	\$2,362	\$2,576	+ \$950	+ \$1,045	+ \$1,140
L	51 3/8"	23 1/2"	23 1/2"	STWR5124BBFL(J/B/R)	\$2,197	\$2,417	\$2,636	+ \$970	+ \$1,067	+ \$1,164
R	51 3/8"	23 1/2"	23 1/2"	STWR5124BBFR(J/B/R)	\$2,197	\$2,417	\$2,636	+ \$970	+ \$1,067	+ \$1,164

## 56" High — includes 1 adj. shelf

L	56"	23 1/2"	23 1/2"	STWR5624FFL(J/B/R)	\$2,197	\$2,417	\$2,636	+ \$970	+ \$1,067	+ \$1,164
R	56"	23 1/2"	23 1/2"	STWR5624FFR(J/B/R)	\$2,197	\$2,417	\$2,636	+ \$970	+ \$1,067	+ \$1,164
L	56"	23 1/2"	23 1/2"	STWR5624BBFL(J/B/R)	\$2,297	\$2,527	\$2,756	+ \$1,000	+ \$1,100	+ \$1,200
R	56"	23 1/2"	23 1/2"	STWR5624BBFR(J/B/R)	\$2,297	\$2,527	\$2,756	+ \$1,000	+ \$1,100	+ \$1,200

## 66" High — includes 2 adj. shelves

L	65 7/8"	23 1/2"	23 1/2"	STWR6624FFL(J/B/R)	\$2,397	\$2,637	\$2,876	+ \$1,200	+ \$1,320	+ \$1,440
R	65 7/8"	23 1/2"	23 1/2"	STWR6624FFR(J/B/R)	\$2,397	\$2,637	\$2,876	+ \$1,200	+ \$1,320	+ \$1,440
L	65 7/8"	23 1/2"	23 1/2"	STWR6624BBFL(J/B/R)	\$2,447	\$2,692	\$2,936	+ \$1,300	+ \$1,430	+ \$1,560
R	65 7/8"	23 1/2"	23 1/2"	STWR6624BBFR(J/B/R)	\$2,447	\$2,692	\$2,936	+ \$1,300	+ \$1,430	+ \$1,560

								Options		
STWR	Tower	H	W	Drawers	Coat Door	Pull		DL	Digital Lock	\$357
		56	22	FF BBF	L Left R Right	J B Bar Pull R Radiused Pull				
STWR		56	22	FF	L	J		DL		

### Specify

1. Model #
2. Case finish
3. Front finish  
*Laminate not available on J pull*

### Pulls



B – Bar Pull



J – J Pull



R – Radiused

### Application Notes

- Single lock for all doors & drawers
- Coat closet includes side-to-side coat rod
- Leveling glides allow for 7/8" adjustment

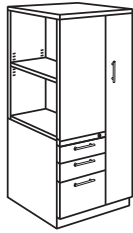

SSAT5624BBFRB

## 46" High — does not include an adj. shelf

COAT DOOR	H	W	D	MODEL #	PAINT		
					P1	P2	P3
L	46"	23 1/2"	23 1/2"	SSAT4624FFL(J/B/R)	\$2,077	\$2,285	\$2,492
R	46"	23 1/2"	23 1/2"	SSAT4624FFR(J/B/R)	\$2,077	\$2,285	\$2,492
L	46"	23 1/2"	23 1/2"	SSAT4624BBFL(J/B/R)	\$2,127	\$2,340	\$2,552
R	46"	23 1/2"	23 1/2"	SSAT4624BBFR(J/B/R)	\$2,127	\$2,340	\$2,552

## 51" High — includes 1 adj. shelf

L	51 3/8"	23 1/2"	23 1/2"	SSAT5124FFL(J/B/R)	\$2,147	\$2,362	\$2,576
R	51 3/8"	23 1/2"	23 1/2"	SSAT5124FFR(J/B/R)	\$2,147	\$2,362	\$2,576
L	51 3/8"	23 1/2"	23 1/2"	SSAT5124BBFL(J/B/R)	\$2,197	\$2,417	\$2,636
R	51 3/8"	23 1/2"	23 1/2"	SSAT5124BBFR(J/B/R)	\$2,197	\$2,417	\$2,636

## 56" High — includes 1 adj. shelf

L	56"	23 1/2"	23 1/2"	SSAT5624FFL(J/B/R)	\$2,227	\$2,450	\$2,672
R	56"	23 1/2"	23 1/2"	SSAT5624FFR(J/B/R)	\$2,227	\$2,450	\$2,672
L	56"	23 1/2"	23 1/2"	SSAT5624BBFL(J/B/R)	\$2,327	\$2,560	\$2,792
R	56"	23 1/2"	23 1/2"	SSAT5624BBFR(J/B/R)	\$2,327	\$2,560	\$2,792

## 66" High — includes 2 adj. shelves

L	65 7/8"	23 1/2"	23 1/2"	SSAT6524FFL(J/B/R)	\$2,347	\$2,582	\$2,816
R	65 7/8"	23 1/2"	23 1/2"	SSAT6524FFR(J/B/R)	\$2,347	\$2,582	\$2,816
L	65 7/8"	23 1/2"	23 1/2"	SSAT6524BBFL(J/B/R)	\$2,397	\$2,637	\$2,876
R	65 7/8"	23 1/2"	23 1/2"	SSAT6524BBFR(J/B/R)	\$2,397	\$2,637	\$2,876

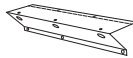

## Worksurface Supporting Bracket — factory installed

BLACK ONLY

Add at the end of tower model number

SWSSB

\$97

							Options		
SSAT	Side Access Tower	H	W	Drawers	Coat Door	Pull			
		56	22	FF BBF	L Left R Right	J J Pull B Bar Pull R Radiused Pull	SWSSB		\$97
							DL	Digital Lock	\$357
SSAT		56	22	FF	L	J	SWSSB		

### Specify

1. Model #
2. Case finish

### Pulls

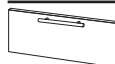

B – Bar Pull



J – J Pull



R – Radiused

### Application Notes

- Includes 2 locks, keyed alike
- Coat closet includes side-to-side coat rod
- Leveling glides allow for 1 5/8" adjustment

### Worksurface Supporting Bracket

Must be ordered with a Side Access Tower. Factory installed.

# Towers

15" Wide



STWR5615FFLB

## 46" High — does not include an adj. shelf

HINGE	H	W	D	MODEL #	PAINT		
					P1	P2	P3
L	46"	15 1/4"	23 1/2"	STWR4615FFL(J/B/R)	\$1,347	\$1,482	\$1,616
R	46"	15 1/4"	23 1/2"	STWR4615FFR(J/B/R)	\$1,347	\$1,482	\$1,616
L	46"	15 1/4"	23 1/2"	STWR4615BBFL(J/B/R)	\$1,477	\$1,625	\$1,772
R	46"	15 1/4"	23 1/2"	STWR4615BBFR(J/B/R)	\$1,477	\$1,625	\$1,772

## 51" High — includes 1 adj. shelf

L	51 3/8"	15 1/4"	23 1/2"	STWR5115FFL(J/B/R)	\$1,477	\$1,625	\$1,772
R	51 3/8"	15 1/4"	23 1/2"	STWR5115FFR(J/B/R)	\$1,477	\$1,625	\$1,772
L	51 3/8"	15 1/4"	23 1/2"	STWR5115BBFL(J/B/R)	\$1,547	\$1,702	\$1,856
R	51 3/8"	15 1/4"	23 1/2"	STWR5115BBFR(J/B/R)	\$1,547	\$1,702	\$1,856

## 56" High — includes 1 adj. shelf

L	56"	15 1/4"	23 1/2"	STWR5615FFL(J/B/R)	\$1,477	\$1,625	\$1,772
R	56"	15 1/4"	23 1/2"	STWR5615FFR(J/B/R)	\$1,477	\$1,625	\$1,772
L	56"	15 1/4"	23 1/2"	STWR5615BBFL(J/B/R)	\$1,547	\$1,702	\$1,856
R	56"	15 1/4"	23 1/2"	STWR5615BBFR(J/B/R)	\$1,547	\$1,702	\$1,856

## 66" High — includes 2 adj. shelves

L	65 7/8"	15 1/4"	23 1/2"	STWR6615FFL(J/B/R)	\$1,597	\$1,757	\$1,916
R	65 7/8"	15 1/4"	23 1/2"	STWR6615FFR(J/B/R)	\$1,597	\$1,757	\$1,916
L	65 7/8"	15 1/4"	23 1/2"	STWR6615BBFL(J/B/R)	\$1,697	\$1,867	\$2,036
R	65 7/8"	15 1/4"	23 1/2"	STWR6615BBFR(J/B/R)	\$1,697	\$1,867	\$2,036

								Options		
STWR	Tower	H	W	Drawers	Coat Door	Pull		DL	Digital Lock	\$357
		56	15	FF BBF	L Left R Right	J B Bar Pull R Radiused Pull				
STWR		56	15	FF	L	J		DL		

### Specify

1. Model #
2. Case finish

### Pulls



B – Bar Pull



R – Radiused



J – J Pull

### Application Notes

- Single lock for cupboard & drawers
- Leveling glides allow for 7/8" adjustment
- Will not accommodate worksurface support bracket



SSAT5615BBFLB

### 46" High — does not include an adj. shelf

OPEN	H	W	D	MODEL #	PAINT		
					P1	P2	P3
L	46"	15 1/4"	23 1/2"	SSAT4615FFL(J/B/R)	\$1,297	\$1,427	\$1,556
R	46"	15 1/4"	23 1/2"	SSAT4615FFR(J/B/R)	\$1,297	\$1,427	\$1,556
L	46"	15 1/4"	23 1/2"	SSAT4615BBFL(J/B/R)	\$1,397	\$1,537	\$1,676
R	46"	15 1/4"	23 1/2"	SSAT4615BBFR(J/B/R)	\$1,397	\$1,537	\$1,676

### 51" High — includes 1 adj. shelf

L	51 3/8"	15 1/4"	23 1/2"	SSAT5115FFL(J/B/R)	\$1,397	\$1,537	\$1,676
R	51 3/8"	15 1/4"	23 1/2"	SSAT5115FFR(J/B/R)	\$1,397	\$1,537	\$1,676
L	51 3/8"	15 1/4"	23 1/2"	SSAT5115BBFL(J/B/R)	\$1,497	\$1,647	\$1,796
R	51 3/8"	15 1/4"	23 1/2"	SSAT5115BBFR(J/B/R)	\$1,497	\$1,647	\$1,796

### 56" High — includes 1 adj. shelf

L	56"	15 1/4"	23 1/2"	SSAT5615FFL(J/B/R)	\$1,497	\$1,647	\$1,796
R	56"	15 1/4"	23 1/2"	SSAT5615FFR(J/B/R)	\$1,497	\$1,647	\$1,796
L	56"	15 1/4"	23 1/2"	SSAT5615BBFL(J/B/R)	\$1,597	\$1,757	\$1,916
R	56"	15 1/4"	23 1/2"	SSAT5615BBFR(J/B/R)	\$1,597	\$1,757	\$1,916

### 66" High — includes 2 adj. shelves

L	65 7/8"	15 1/4"	23 1/2"	SSAT6515FFL(J/B/R)	\$1,547	\$1,702	\$1,856
R	65 7/8"	15 1/4"	23 1/2"	SSAT6515FFR(J/B/R)	\$1,547	\$1,702	\$1,856
L	65 7/8"	15 1/4"	23 1/2"	SSAT6515BBFL(J/B/R)	\$1,647	\$1,812	\$1,976
R	65 7/8"	15 1/4"	23 1/2"	SSAT6515BBFR(J/B/R)	\$1,647	\$1,812	\$1,976

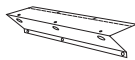

### Worksurface Supporting Bracket — factory installed

BLACK ONLY

Add at the end of tower model number

SWSSB

\$97

## WORKSURFACES & 15" SIDE ACCESS TOWERS

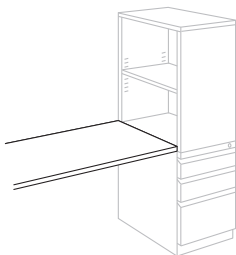

When adding a 15" tower to the end of a work surface you will need to add a "T" to the end of the model number in order to make the work surface and tower completely flush. This will only be necessary on 24" deep work surfaces with a width from 48" – 84".

							Options	
SSAT	Side Access Tower	H	W	Drawers	Coat Door	Pull		
		56	15	FF BBF	L Left R Right	J J Pull B Bar Pull R Radiused Pull	SWSSB	\$97
							DL	Digital Lock \$357
SSAT		56	15	FF	L	J	SWSSB	

#### Specify

1. Model #
2. Case finish

#### Pulls

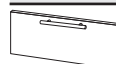

B – Bar Pull



J – J Pull



R – Radiused

#### Application Notes

- Single lock for all drawers
- Leveling glides allow for 1 5/8" adjustment

#### Worksurface Supporting Bracket

Must be ordered with a Side Access Tower. Factory installed.

# Credenzas

## General Info

### Step 1 – Model #

SCR	Credenza	Drawer Width	Shelf Width	Top	Pull
SCR	Credenza	30 D Drawer	20 S Shelf	MT Metal Top NT No Top	J J Pull B Bar Pull
SCR		30 D	20 S	MT	B

### Step 2 – Case Finish

Paint
301 Champagne
301

### Step 3 – Front Finish

Not Available w/J Pull	
Laminate	
PW-STK	Studio Teak
PW-STK	

## FEATURES

### COUNTERWEIGHT

- Two drawer cabinets include factory installed counterweights
- Low storage cabinets that do not include shelves do not need counterweight

### LOCK

- Available on credenza products which feature drawers
- Lock core is removable
- Keyed alike available upon request
- Master and change key available upon request. See (page 9).

### DRAWERS

- Include full suspension steel ball-bearing slides
- Drawer fronts include rubber bumpers for quiet operation

### SHELF

¾" High adjustable shelf

### LEVELING GLIDES

4 Leveling glides allow for ½" adjustment

### TOP

Available in metal, cushion and laminate

## CONSTRUCTION

### OUTER SHELL & DRAWER CONSTRUCTION

Welded steel frame construction & formed channels ensure strength in key areas.

Bottom channels	16 Gauge
Top channels	18 Gauge
Shelves	18 Gauge
Side channels	20 Gauge
Side panels	20 Gauge
Top	20 Gauge
Fronts	20 Gauge
Drawer bins	22 Gauge

### DRAWER INNER DIMENSIONS

#### Height

6" Drawer	4 ½"
12" Drawer	10 ¾"

#### Width

30" Wide drawer	26 ⅞"
36" Wide drawer	32 ⅞"
42" Wide drawer	38 ⅞"

#### Depth

All drawers	15 ⅞"
-------------	-------

### SHELF INNER DIMENSIONS

#### Height

All shelves	16 ⅞"
-------------	-------

#### Width

30" Wide drawer	28 ½"
36" Wide drawer	34 ½"
42" Wide drawer	40 ½"

#### Depth

All drawers	19"
-------------	-----

## PULL STYLES

Available with Laminate Front



B – Bar Pull



J – J Pull

## SURFACE MATERIALS

### CASE

Paint

### FRONTS

w/Bar pull (B)	Paint or Laminate
w/J pull (J)	Paint

### DRAWER PULL

Bar (B)	Satin nickel
J (J)	Paint

### LOCK

Satin nickel

### CUSHION TOP

Upholstery

# CREDENZAS

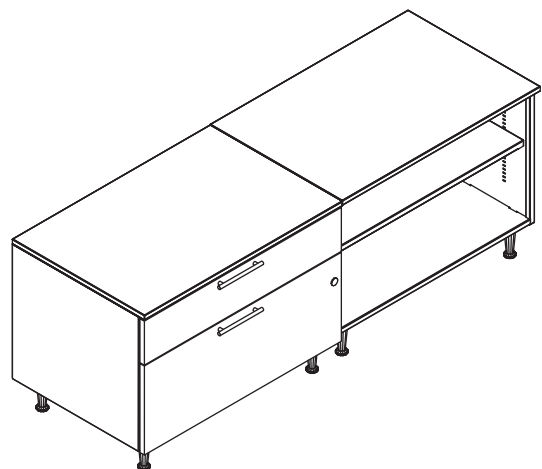

Storage

# Credenzas

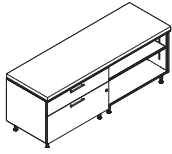

## Credenzas

DESCRIPTION	H	W	D	MODEL #	PAINT			LAMINATE FRONT (UPCHARGE)		
					P1	P2	P3	L1	L2	L3
30" Drawers, 30" open shelf	22 1/4"	60"	20"	SCR30D30S(J/B)	\$2,783	\$3,061	\$3,340	+\$530	+\$583	+\$636
30" Drawers, 36" open shelf	22 1/4"	66"	20"	SCR30D36S(J/B)	\$2,868	\$3,155	\$3,442	+\$530	+\$583	+\$636
36" Drawers, 36" open shelf	22 1/4"	72"	20"	SCR36D36S(J/B)	\$2,928	\$3,221	\$3,514	+\$550	+\$605	+\$660



## Credenza – Drawers

30" Drawers, metal top	22 1/4"	30"	20"	SCRD3020MT(J/B)	\$1,147	\$1,262	\$1,376	+\$530	+\$583	+\$636
36" Drawers, metal top	22 1/4"	36"	20"	SCRD3620MT(J/B)	\$1,197	\$1,317	\$1,436	+\$550	+\$605	+\$660
42" Drawers, metal top	22 1/4"	42"	20"	SCRD4220MT(J/B)	\$1,297	\$1,427	\$1,556	+\$590	+\$649	+\$708



## Credenza – Shelves — includes 1 adj. shelf

30" Shelf, metal top	22 1/4"	30"	20"	SCR3020MT	\$917	\$1,009	\$1,100	N/A	N/A	N/A
36" Shelf, metal top	22 1/4"	36"	20"	SCR3620MT	\$977	\$1,075	\$1,172	N/A	N/A	N/A
42" Shelf, metal top	22 1/4"	42"	20"	SCR4220MT	\$1,057	\$1,163	\$1,268	N/A	N/A	N/A

## Credenza – Accessories

Floating top supports, 2 legs	5 1/2"	2 1/2"	1 1/8"	SCRSL2	\$247	\$272	\$296	N/A	N/A	N/A
Credenza center leg support				SCRCLS	\$197	N/A	N/A	N/A	N/A	N/A
Credenza ganging kit				SCRGK	\$147	N/A	N/A	N/A	N/A	N/A

										Options				
		Drawer Width		Shelf Width		Top		Pull						
SCR	Credenza	30	D	Drawer	20	S	Shelf	MT	Metal Top	J	J Pull	DL	Digital Lock	\$357
										B	Bar Pull			
SCR		30	D		20	S		MT		J		DL		

### Specify

1. Model #
2. Case finish
3. Front finish  
*Laminate not available on J pull*

### Credenza Includes

- 2 low storage cabinets
- 1 laminate top & ganging kit
- 1 credenza center support leg

### Pulls

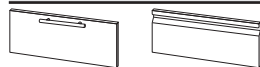

B – Bar Pull

J – J Pull

### Application Notes

- Credenzas must be assembled in the field
- When ganging 2 units together, order ganging kit
- Leveling glides allow for 1 5/8" adjustment

- Drawer units include 1 – 6" drawer & 1 – 12" file drawer & counterweight

### Center Leg

- Helps to gang 2 credenza pieces together side by side
- Eliminate the 4 legs in the center and replace with this single support leg

### Ganging Kit

- Ganging kit for use when specifying laminate top separately, does not include center leg

### Floating Top Supports

- Floating top supports may not be used on a metal top, includes top mounting bracket, screws & drill plate



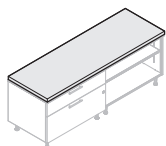

## Credenza – Common Tops

DESCRIPTION	H	W	D	MODEL #	LAMINATE		
					L1	L2	L3
Single 30" W credenza top	5/8"	30"	20"	<b>CT30</b>	\$365	\$402	\$438
Single 36" W credenza top	5/8"	36"	20"	<b>CT36</b>	\$390	\$429	\$468
Single 42" W credenza top	5/8"	42"	20"	<b>CT42</b>	\$420	\$462	\$504
Double 30" W credenza top	5/8"	60"	20"	<b>CT60</b>	\$475	\$523	\$570
Double 30"/36" W credenza top	5/8"	66"	20"	<b>CT66</b>	\$500	\$550	\$600
Double 36" W credenza top OR 30"/42" W credenza top	5/8"	72"	20"	<b>CT72</b>	\$510	\$561	\$612
Double 36"/42" W credenza top	5/8"	78"	20"	<b>CT78</b>	\$530	\$583	\$636
Double 42" W credenza top	5/8"	84"	20"	<b>CT84</b>	\$560	\$616	\$672
Triple 30" W credenza top	5/8"	90"	20"	<b>CT90</b>	\$590	\$649	\$708

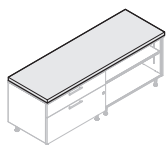

## Credenza Cushion Tops

H	W	D	MODEL #	FABRIC							
				A/1	B/2	C/3	D/4	E/5	F/6	G/7	H/8
1"	12"	20"	<b>SCRC2012</b>	\$207	\$432	\$507	\$607	\$707	\$807	\$1,132	\$1,307
1"	18"	20"	<b>SCRC2018</b>	\$247	\$472	\$547	\$647	\$747	\$847	\$1,172	\$1,347
1"	30"	20"	<b>SCRC2030</b>	\$327	\$552	\$627	\$727	\$827	\$927	\$1,252	\$1,427
1"	36"	20"	<b>SCRC2036</b>	\$397	\$622	\$697	\$797	\$897	\$997	\$1,322	\$1,497
1"	42"	20"	<b>SCRC2042</b>	\$437	\$662	\$737	\$837	\$937	\$1,037	\$1,362	\$1,537
1"	60"	20"	<b>SCRC2060</b>	\$527	\$752	\$827	\$927	\$1,027	\$1,127	\$1,452	\$1,627
1"	66"	20"	<b>SCRC2066</b>	\$567	\$792	\$867	\$967	\$1,067	\$1,167	\$1,492	\$1,667
1"	72"	20"	<b>SCRC2072</b>	\$597	\$822	\$897	\$997	\$1,097	\$1,197	\$1,522	\$1,697

### Specify

1. Model #
2. Case finish
3. Front finish  
*Laminate not available on J pull*

### Pulls

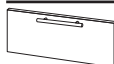

**B – Bar Pull**



**J – J Pull**

### Application Notes

#### Center Leg

- Helps to gang 2 credenza pieces together side by side

#### Ganging Kit

- When ganging 2 units together, order ganging kit, does not include center leg

#### Floating Top Supports

- Floating top supports may not be used on a metal top, includes top mounting bracket, screws & drill plate

# Cabinets

## Step 1 – Model #

SCAB	Cabinet	H	W	D	Pull
SCAB	Cabinet	77	30	18	J B J Pull Bar Pull
SCAB		77	30	18	J

## Step 2 – Case Finish

Paint
301 Champagne
301

## FEATURES

### LOCK

- Lock core is removable.
- Keyed alike available upon request.
- Master and change key available upon request. See (page 9).

### DOORS

- Concealed hinges allow for 110° degrees opening.

### LEVELING GLIDES

4 Leveling glides allow for ¼" adjustment.

## CONSTRUCTION

### OUTER SHELL & DRAWER CONSTRUCTION

Welded steel frame construction & formed channels ensure strength in key areas.

Back panel	20 – 22 Gauge
Side panels	20 – 22 Gauge
Inner channels	18 Gauge
Top	18 Gauge
Doors	18 Gauge

### SHELF LOAD CAPACITY

Shelf	140 lbs
-------	---------

### TOP LOAD CAPACITY

30" Wide cabinets	140 lbs
36" Wide cabinets	169 lbs
42" Wide cabinets	197 lbs

### INNER DIMENSIONS

#### Height

2 High	23 ½"
3 High	35"
4 High	46 ½"
5 High	61"
6 High	72 ½"

#### Width

30" Wide cabinet	26 ¾"
36" Wide cabinet	32 ¾"
42" Wide cabinet	38 ¾"

#### Depth

18" Deep	17 ¾"
24" Deep	22 ¾"

## PULL STYLES



B – Bar Pull



J – J Pull

## SURFACE MATERIALS

### CASE

Paint

### FRONTS

w/Bar Pull (B)	Paint
w/J Pull (J)	Paint

### DRAWER PULL

Bar (B)	Satin nickel
J (J)	Paint

### LOCK

Satin nickel

# CABINETS

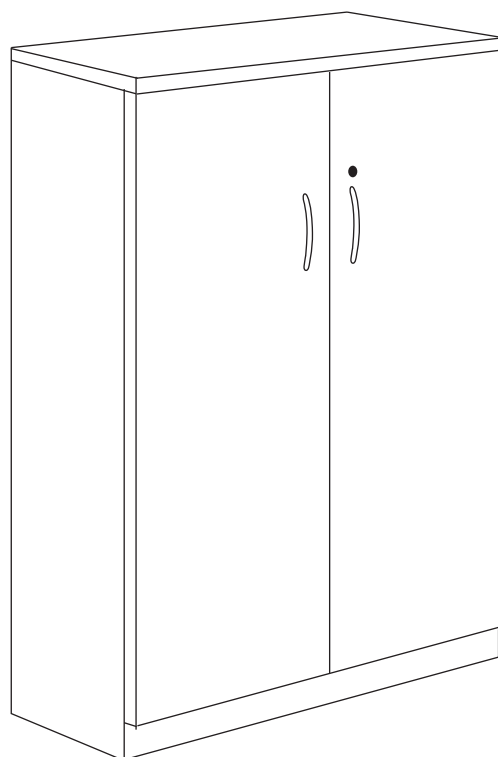

Storage

# Cabinets

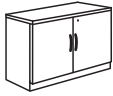

## 2 High

H	W	D	MODEL #	PAINT		
				P1	P2	P3
28 3/8"	30"	18 1/4"	SCAB293018(J/B)	\$997	\$1,097	\$1,196
28 3/8"	36"	18 1/4"	SCAB293618(J/B)	\$1,097	\$1,207	\$1,316
28 3/8"	42"	18 1/4"	SCAB294218(J/B)	\$1,197	\$1,317	\$1,436



## 3 High

39 7/8"	30"	18 1/4"	SCAB403018(J/B)	\$1,197	\$1,317	\$1,436
39 7/8"	36"	18 1/4"	SCAB403618(J/B)	\$1,297	\$1,427	\$1,556
39 7/8"	42"	18 1/4"	SCAB404218(J/B)	\$1,397	\$1,537	\$1,676



## 4 High

51 3/8"	30"	18 1/4"	SCAB523018(J/B)	\$1,447	\$1,592	\$1,736
51 3/8"	36"	18 1/4"	SCAB523618(J/B)	\$1,547	\$1,702	\$1,856
51 3/8"	42"	18 1/4"	SCAB524218(J/B)	\$1,647	\$1,812	\$1,976

### Specify

1. Model #
2. Case finish

### Application Notes

- Leveling glides allow for 1/4" adjustment

		H	W	D	Pull		Options	
SCAB	Cabinet	77	30	18	J B	J Pull Bar Pull	DL	Digital Lock \$357
SCAB		77	30	18	J		DL	

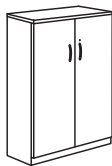

## 5 High

H	W	D	MODEL #	PAINT		
				P1	P2	P3
65 7/8"	30"	18 1/4"	SCAB663018(J/B)	\$1,647	\$1,812	\$1,976
65 7/8"	36"	18 1/4"	SCAB663618(J/B)	\$1,747	\$1,922	\$2,096
65 7/8"	36"	23 1/2"	SCAB663624(J/B)	\$2,147	\$2,362	\$2,576
65 7/8"	42"	18 1/4"	SCAB664218(J/B)	\$1,847	\$2,032	\$2,216

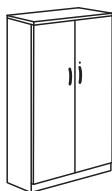

## 6 High

77 3/8"	30"	18 1/4"	SCAB773018(J/B)	\$1,897	\$2,087	\$2,276
77 3/8"	36"	18 1/4"	SCAB773618(J/B)	\$1,997	\$2,197	\$2,396
77 3/8"	36"	23 1/2"	SCAB773624(J/B)	\$2,247	\$2,472	\$2,696
77 3/8"	42"	18 1/4"	SCAB774218(J/B)	\$2,097	\$2,307	\$2,516

### Specify

1. Model #
2. Case finish

### Application Notes

- Leveling glides allow for 1/4" adjustment

		H	W	D	Pull		Options		
SCAB	Cabinet	77	30	18	J	J Pull B Bar Pull	DL	Digital Lock	\$357
SCAB		77	30	18	J		DL		

# Lockers

## Step 1 – Model #

		H	D	Hinge	Pull
SLKR	Locker	51	18	L R	J B J Pull Bar Pull
<b>SLKR</b>		<b>51</b>	<b>18</b>	<b>L</b>	<b>J</b>

## Step 2 – Case Finish

Paint
301 Champagne
<b>301</b>

## FEATURES

### LOCK

- Lock core is removable.
- Keyed alike available upon request.
- Master and change key available upon request. See (page 9).
- Digital lock available upon request.
- Keyless available upon request.

### BODY

- Available in 2 depths: 18 ¼" and 23 ½".

### DOORS

- All lockers come standard with metal doors.
- Concealed hinges allow for 100 degree opening.

### SHELF

- Includes one fixed shelf on top w/ 12" clear height above.
- Additional shelves may be ordered separately.

### COAT ROD

Includes side-to-side coat rod beneath shelf.

### LEVELING GLIDES

- 4 leveling glides allow for 7/8" adjustment.
- Glides are accessible from the inside of the locker.

## CONSTRUCTION

### OUTER SHELL & DRAWER CONSTRUCTION

Welded steel frame construction & formed channels ensure strength in key areas.

Top panel	21 Gauge
Side panels	21 Gauge
Back panel	21 Gauge
Center panel	21 Gauge
Inner top channel	18 Gauge
Inner bottom channel	18 Gauge
Inner side channels	18 Gauge
Bottom panel	16 Gauge
Door fronts	20 – 22 Gauge
Shelves	18 Gauge

### DRAWER INNER DIMENSIONS

#### Height

Above shelf	12"
Below coat rod – 51" High	31 7/10"
Below coat rod – 66" High	46 1/5"

#### Width

All lockers	9 4/5"
-------------	--------

#### Depth

18 ½" Deep locker	17 3/5"
23 ½" Deep locker	22 3/5"

## PULL STYLES



B – Bar Pull



J – J Pull

## SURFACE MATERIALS

### LOCKER

Paint

### DRAWER PULL

Bar (B)

J (J)

Satin nickel

Paint

### LOCK

Satin nickel

# LOCKERS

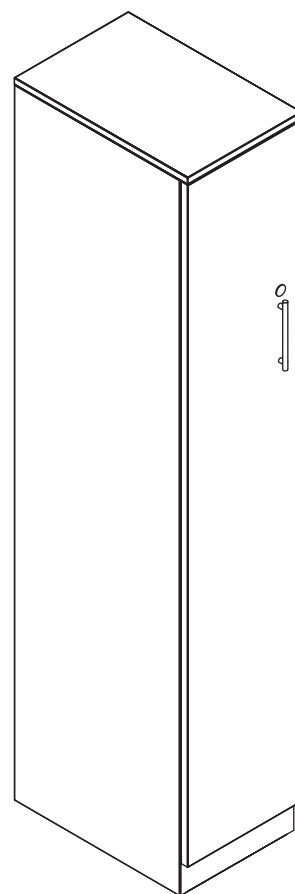

Storage

# Lockers

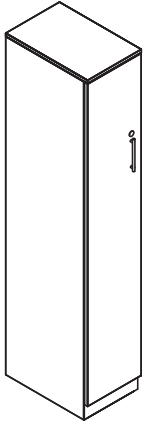

## 12" Wide — 51" High

HINGE	H	W	D	MODEL #	PAINT		
					P1	P2	P3
L	51 3/8"	12"	18"	SLKR5118L(J/B)	\$1,397	\$1,537	\$1,676
R	51 3/8"	12"	18"	SLKR5118R(J/B)	\$1,397	\$1,537	\$1,676
L	51 3/8"	12"	24"	SLKR5124L(J/B)	\$1,427	\$1,570	\$1,712
R	51 3/8"	12"	24"	SLKR5124R(J/B)	\$1,427	\$1,570	\$1,712

## 12" Wide — 66" High

L	65 7/8"	12"	18"	SLKR6618L(J/B)	\$1,477	\$1,625	\$1,772
R	65 7/8"	12"	18"	SLKR6618R(J/B)	\$1,477	\$1,625	\$1,772
L	65 7/8"	12"	24"	SLKR6624L(J/B)	\$1,527	\$1,680	\$1,832
R	65 7/8"	12"	24"	SLKR6624R(J/B)	\$1,527	\$1,680	\$1,832

### Specify

1. Model #
2. Case finish

### Application Notes

- Includes 1 fixed shelf on top with 12" clear height above
- Side to side coat rod under shelf
- Leveling glides allow for 7/8" adjustment

		H	D	Hinge	Pull	Options
SLKR	Locker	51	18	L R	J B J Pull Bar Pull	DL Digital Lock \$357
SLKR		51	18	L	J	DL





## Double

TYPE	HINGE	H	W	D	MODEL #	PAINT		
						P1	P2	P3
2 Door	L	65 7/8"	12"	18"	SLKR2D6612L(J/B)	\$1,607	\$1,768	\$1,928
2 Door	R	65 7/8"	12"	18"	SLKR2D6612R(J/B)	\$1,607	\$1,768	\$1,928
2 Door	L	65 7/8"	18"	18"	SLKR2D6618L(J/B)	\$1,707	\$1,878	\$2,048
2 Door	R	65 7/8"	18"	18"	SLKR2D6618R(J/B)	\$1,707	\$1,878	\$2,048

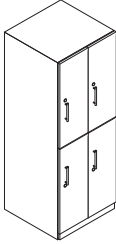

## Quad

4 Door	L	65 7/8"	24"	18"	SLKR4D6624L(J/B)	\$2,707	\$2,978	\$3,248
4 Door	R	65 7/8"	24"	18"	SLKR4D6624R(J/B)	\$2,707	\$2,978	\$3,248

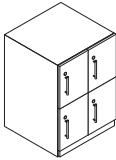

## Cubby

4 Door	L	34 3/4"	24"	18"	SLKR4D3524L(J/B)	\$1,907	\$2,098	\$2,288
4 Door	R	34 3/4"	24"	18"	SLKR4D3524R(J/B)	\$1,907	\$2,098	\$2,288
8 Door	L	65 7/8"	24"	18"	SLKR8D6624L(J/B)	\$3,307	\$3,638	\$3,968
8 Door	R	65 7/8"	24"	18"	SLKR8D6624R(J/B)	\$3,307	\$3,638	\$3,968

## Shelves

Qty 2		12"		SLKRS122	\$257	\$283	\$308
Qty 2		18"		SLKRS182	\$297	\$327	\$356
Qty 4		24"		SLKRS244	\$357	\$393	\$428

### Specify

1. Model #
2. Case finish

### Application Notes

- Doors are keyed randomly
- Locking doors hinge left or right
- Leveling glides allow for 7/8" adjustment

							Options		
SLKR	Locker	Doors	H	D	Hinge	Pull	DL	Digital Lock	\$357
		2D 4D 8D	66	18	L R	J B Bar Pull			
SLKR		2D	66	18	L	J	DL		

# Bookcases

## Step 1 – Model #

	H	W
SBC Bookcase	66	42
SBC	66	42

## Step 2 – Case Finish

Paint
301 Champagne
301

## FEATURES

### SHELVES

- 1" thick.
- Adjustable in ½" increments.
- 2-high bookcases will accommodate binder-height storage on both shelves.
- All other bookcases, binder-height storage is available on all but 1 shelf.

### LEVELING GLIDES

4 Leveling glides allow for 1 ⅝" adjustment.

### SAFETY:

- To ensure stability, do not install a 4, 5 or 6 high bookcase in the center of a room.
- Bookcases should be installed back-to-back or against a wall.

### NOTE

- 2 high bookcases are slightly shorter than 2-high lateral files and double door storage cabinets.
- 2 high bookcases are designed to fit under a worksurface.

## CONSTRUCTION

### OUTER SHELL & DRAWER CONSTRUCTION

Welded steel frame construction & formed channels ensure strength in key areas.

Side channels	22 Gauge
Side panels	22 Gauge
Bottom panel	18 Gauge
Shelves	18 Gauge

### SHELF LOAD CAPACITY

All bookcases	140 lbs
---------------	---------

### INNER DIMENSIONS

#### Height

2 High	25 ½"
3 High	37 ¾"
4 High	48 ½"
5 High	63 ¾"
6 High	74 ½"

#### Width

30" Wide bookcase	27 7/10"
36" Wide bookcase	33 7/10"
42" Wide bookcase	39 7/10"

#### Depth

All cabinets	13 1/10"
--------------	----------

## SURFACE MATERIALS

### CASE

Paint

### TOP

Paint

# BOOKCASES

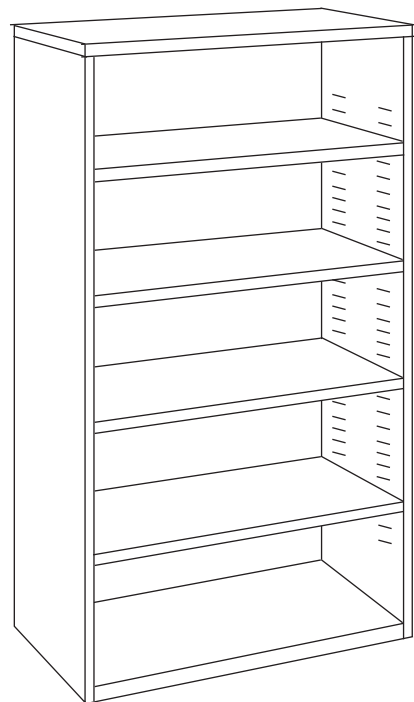

Storage

# Bookcases



## 2 High

H	W	D	MODEL #	PAINT		
				P1	P2	P3
27 ¾"	30"	13 ⅜"	<b>SBC2830</b>	\$827	\$910	\$992
27 ¾"	36"	13 ⅜"	<b>SBC2836</b>	\$877	\$965	\$1,052
27 ¾"	42"	13 ⅜"	<b>SBC2842</b>	\$977	\$1,075	\$1,172



## 3 High

39 ⅞"	30"	13 ⅜"	<b>SBC4030</b>	\$897	\$987	\$1,076
39 ⅞"	36"	13 ⅜"	<b>SBC4036</b>	\$977	\$1,075	\$1,172
39 ⅞"	42"	13 ⅜"	<b>SBC4042</b>	\$1,077	\$1,185	\$1,292



## 4 High

51 ⅜"	30"	13 ⅜"	<b>SBC5230</b>	\$997	\$1,097	\$1,196
51 ⅜"	36"	13 ⅜"	<b>SBC5236</b>	\$1,077	\$1,185	\$1,292
51 ⅜"	42"	13 ⅜"	<b>SBC5242</b>	\$1,177	\$1,295	\$1,412

### Specify

1. Model #
2. Case finish

### Application Notes

- Steel frame construction
- Double wall construction on side panels
- Leveling glides allow for ⅝" adjustment
- Shelves adjust in ½" increments
- Bookcases should be installed with back against a wall
- Shelf capacity 140 lbs
- 2 high bookcase is slightly shorter than 2 door cabinet as it is designed to fit under a worksurface

		H	W
<b>SBC</b>	<b>Bookcase</b>	<b>66</b>	<b>42</b>
<b>SBC</b>		<b>66</b>	<b>42</b>



## 5 High

H	W	D	MODEL #	PAINT		
				P1	P2	P3
65 7/8"	30"	13 3/8"	<b>SBC6630</b>	\$1,097	\$1,207	\$1,316
65 7/8"	36"	13 3/8"	<b>SBC6636</b>	\$1,177	\$1,295	\$1,412
65 7/8"	42"	13 3/8"	<b>SBC6642</b>	\$1,277	\$1,405	\$1,532

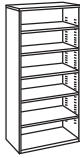

## 6 High

77 3/8"	30"	13 3/8"	<b>SBC7730</b>	\$1,197	\$1,317	\$1,436
77 3/8"	36"	13 3/8"	<b>SBC7736</b>	\$1,277	\$1,405	\$1,532
77 3/8"	42"	13 3/8"	<b>SBC7742</b>	\$1,377	\$1,515	\$1,652

### Specify

1. Model #
2. Case finish

### Application Notes

- Steel frame construction
- Double wall construction on side panels
- Leveling glides allow for 5/8" adjustment
- Shelves adjust in 1/2" increments
- Bookcases should be installed with back against a wall.
- Shelf capacity 140 lbs
- 2 high bookcase is slightly shorter than 2 door cabinet as it is designed to fit under a worksurface

		H	W
<b>SBC</b>	<b>Bookcase</b>	<b>66</b>	<b>42</b>
<b>SBC</b>		<b>66</b>	<b>42</b>

---

## **WORKPLACE ACCESSORIES**

---

Neutral Posture is proud to offer the complete package for commercial office furniture. Workplace accessories round out our offering and allow users to truly customize their space to be as comfortable and as ergonomic as possible.

### **CUSTOMIZE YOUR SPACE WITH:**

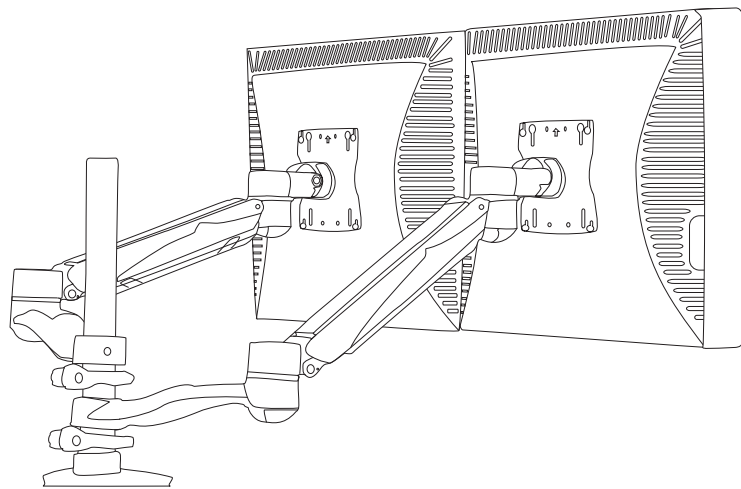

- Keyboard mechanisms
- Keyboard trays
- Monitor arms
- Footrests
- Tablet holders
- CPU holders
- Forearm supports
- Patented ergonomic products

# WORKPLACE ACCESSORIES

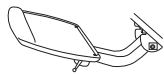

# Keyboard Trays & Arms

## KEYBOARD ARMS

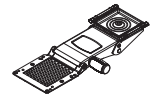
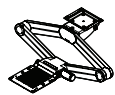
					
	Leverless	Sit/Stand	Econo	Dual Indicator <i>HFES compliant</i>	Ascension
Code	A	C	E	U	T
Leverless Height	✓	✓	N/A	N/A	✓
Height	-6" – 2.5"	-6" – 8"	-5.25" – 0"	-6.5" – 2.38"	-8" – 14"
Tilt	-15° – 0°	-15° – 0°	-15° – 15°	-20° – 10°	-15° – 10°
Spring Assist	✓	✓	✓	✓	✓
360° Rear Swivel	✓	✓	✓	✓	✓
Track Length	23"	21"	18"	19"	21"
(OPTIONAL) Short Track	18"	18"	N/A	N/A	18"
Glide Track	✓	✓	✓	✓	✓
Quick Ship	QS	QS	QS		
List	\$210	\$230	\$160	\$245	\$377

## KEYBOARD TRAYS

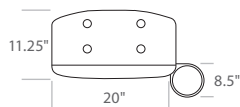

- 11**
- Straights, corners & natural keyboards
  - Anti-skid neoprene pads hold keyboard securely in place

QS

List \$155

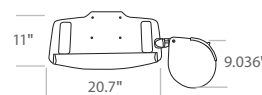

- 52**
- Straight
  - 20" "green" tray
  - Height adjustable tilt & swivel mouse
  - Gel filled palm rest

QS ♻️

List \$325

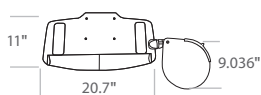

- 21**
- Straight
  - 20" phenolic tray
  - Height adjustable tilt & swivel mouse
  - Gel filled palm rest

List \$325

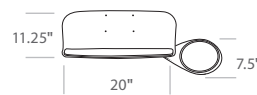

- 86 — ELEMENTAL®**
- Straights, corners and natural keyboards
  - Made from 100% recycled aluminum
  - Polished surface

QS ♻️

List \$295

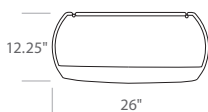

- 43 — SOFTOUCH™**
- Straight
  - Urethane over steel plate
  - Includes mouse surface

QS

List \$230



## ASCENSION — SIT TO STAND KEYBOARD ARM

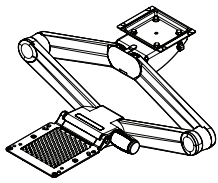

### T — ASCENSION ARM



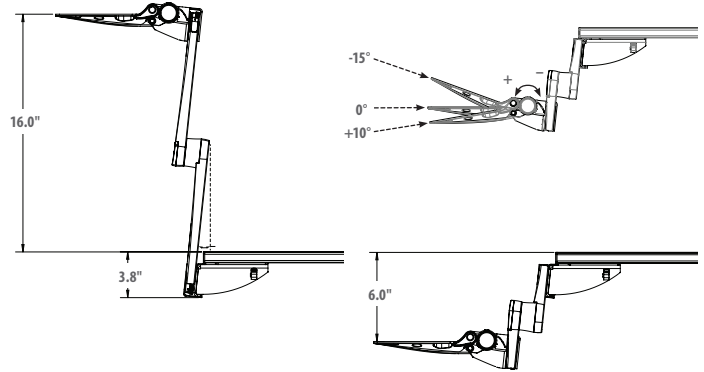
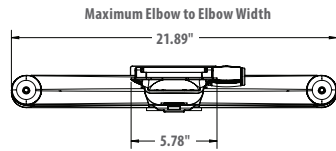

- Low profile arm and tray head
- Concealed hardware
- Clear access to tilt control knob

List \$377

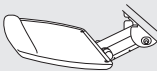
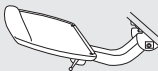

## EASY COMBOS

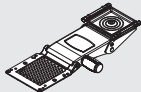
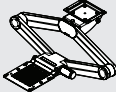
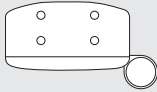
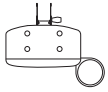
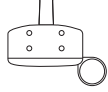
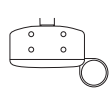
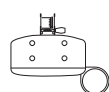
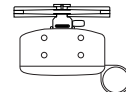
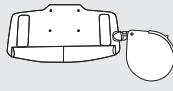
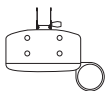
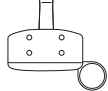
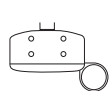
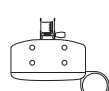
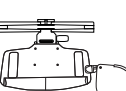
### Keyboard Arms

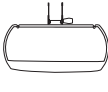
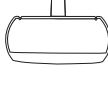
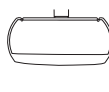
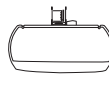
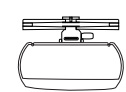
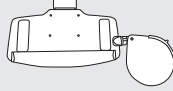
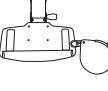
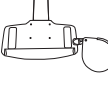
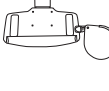
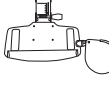
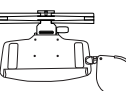
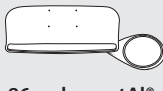
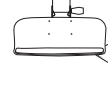
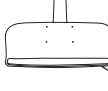
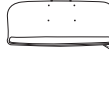
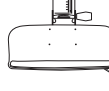
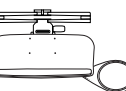
	 Leverless (A)	 Sit/Stand (C)	 Econo (E)	 Dual Indicator (U)	 Ascension (T)
 11	 <b>Easy A11</b> \$365	 <b>Easy C11</b> \$385	 <b>Easy E11</b> \$315	 <b>Easy U11</b> \$400	 <b>Easy T11</b> \$532
 21	 <b>Easy A21</b> \$535	 <b>Easy C21</b> \$555	 <b>Easy E21</b> \$485	 <b>Easy U21</b> \$570	 <b>Easy T21</b> \$702
 43 – SofTouch™	 <b>Easy A43</b> \$440	 <b>Easy C43</b> \$460	 <b>Easy E43</b> \$390	 <b>Easy U43</b> \$475	 <b>Easy T43</b> \$607
 52	 <b>Easy A52</b> \$535	 <b>Easy C52</b> \$555	 <b>Easy E52</b> \$485	 <b>Easy U52</b> \$570	 <b>Easy T52</b> \$702
 86 – elementAI®	 <b>Easy A86</b> \$505	 <b>Easy C86</b> \$525	 <b>Easy E86</b> \$455	 <b>Easy U86</b> \$540	 <b>Easy T86</b> \$672

### General

S Short Track – 18" \$0  
Only available on (A) or (C) arm

# Monitor Arms

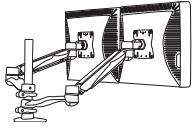

## BOOST™

- Yields 13" of vertical movement & 24" of extension
- Supports monitors weighing up to 20 lbs
- Effortlessly position two monitors at the same height on a single post
- Easily attach two arms on a single post without additional brackets
- Install three or more arms with an optional cross bar
- Convenient keyhole slots to effortlessly install monitor onto mounting plate

**NOTE: For multi-screen solutions, contact [customerservice@neutralposture.com](mailto:customerservice@neutralposture.com)**

Single Arm	Description	List
KCG-110B	Black	\$455
KCG-110S	Silver	\$455
Double Arm	Description	List
KCG-110DB	Black	\$899
KCG-110DS	Silver	\$899
Wall Mount	Description	List
KCG-WMB	Black	\$525
KCG-WMS	Silver	\$525

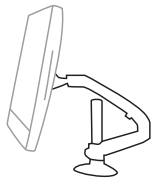

## FREEDOM

- Includes vesa plate aluminum articulating arm & desk clamp base
- Tilt: Up 90°, Down 45°
- Pan: 180°
- Rotation: 360°
- Offers 14" of dynamic one-touch height adjustment
- Full extension range of 23.4"

Model #	Description	List
918001	Silver	\$495

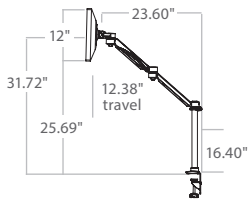

## SIT/STAND

- Sturdy aluminum construction with vesa compatibility
- Width & depth adjustable fasteners
- Convenient pull handle

Model #	Description	List
KCG-SSB	Black	\$575
KCG-SSS	Silver	\$575

## ACCESSORIES

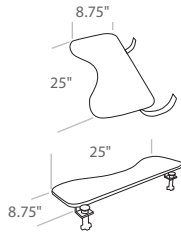

### FOREARM SUPPORTS

- Alleviates shoulder, neck & body burden
- Promotes good posture & ergonomic sitting
- Reduces pressure on ulnar nerve
- Reduces upper body fatigue
- Lightweight & portable



**Model 1**      **Model 2**

160241 \$240	160243 \$240	w/Hooks
160242 \$240	160244 \$240	w/Screws

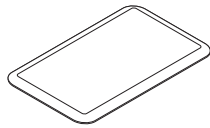

### ANTI-FATIGUE FLOOR MATS

- Premium comfort will not bottom out or lose bounce over time
- Commercial-grade heavy-duty polyurethane
- Matte texture provides optimum traction
- Beveled edge reduces tripping potential
- Available in black

H	W	D	MODEL #	LIST
¾"	32"	20"	<b>EAM3220B</b>	\$285
¾"	48"	20"	<b>EAM4820B</b>	\$435
¾"	72"	20"	<b>EAM7220B</b>	\$648
¾"	36"	24"	<b>EAM3624B</b>	\$360
¾"	60"	36"	<b>EAM6036B</b>	\$828

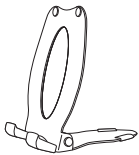

### TABLET HOLDER

- Light weight & portable
- Dimensions: 6.76 x 5.5 x 2
- Holds tablets, phones or documents upright
- Easily adjusts for comfortable viewing angle
- Rests on desktop or flat surfaces
- Available in black only

**Model #**      **List**  
TABHLDR      \$137

## CPU HOLDERS

### CPU HOLDER

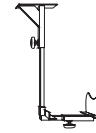

- Mounts easily under worksurface storing CPU safely under desk & off the floor
- Adjusts to either a vertical or horizontal position
- Adjustable width of 5.5" – 9.8" & height of 15.5" – 20"

**Model #**      **List**  
VCPUF      \$175

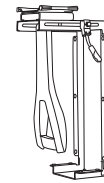

### CPU HOLDER

- CPU retracts on a 17" track & swivels to allow full accessibility & easy storage
- Accommodates CPU weighing up to 75 lbs & measuring 64" in perimeter
- Installation is quick & easy
- Soft touch anti-slip pads prevent CPU from slipping

**Model #**      **List**  
VCPU      \$195

# Sit/Stand



## STANDUP®

- Retrofits between most existing keyboard trays & keyboard arms
- Mounts directly to worksurface without keyboard arm
- Additional 2" – 11" of height adjustment
- Infinite range positioning
- \$50 discount when ordered with any Easy Combo ((page 171))

MODEL #	LIST
SUP04	\$420

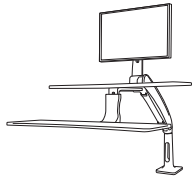

## STANDUP® A1

- The integral dual tray system offers a spacious keyboard & mouse platform as well as a secondary surface for other items
- Extends forward to allow the keyboard tray to rest below the desk surface supporting proper ergonomic positioning
- Over 22" of assisted positioning
- Accommodates users ranging from 5<sup>th</sup> percentile seated female to 95<sup>th</sup> percentile standing male
- Supports monitors weighing between 5–20 lbs
- Supports technology ranging from 5–25 lbs
- Grommet or clamp mount
- Single or dual monitor

1 MONITOR	MECH	LIST
SUPA1B	Black	\$997
SUPA1S	Silver	\$997

2 MONITORS	MECH	LIST
SUPA2B	Black	\$1,187
SUPA2S	Silver	\$1,187

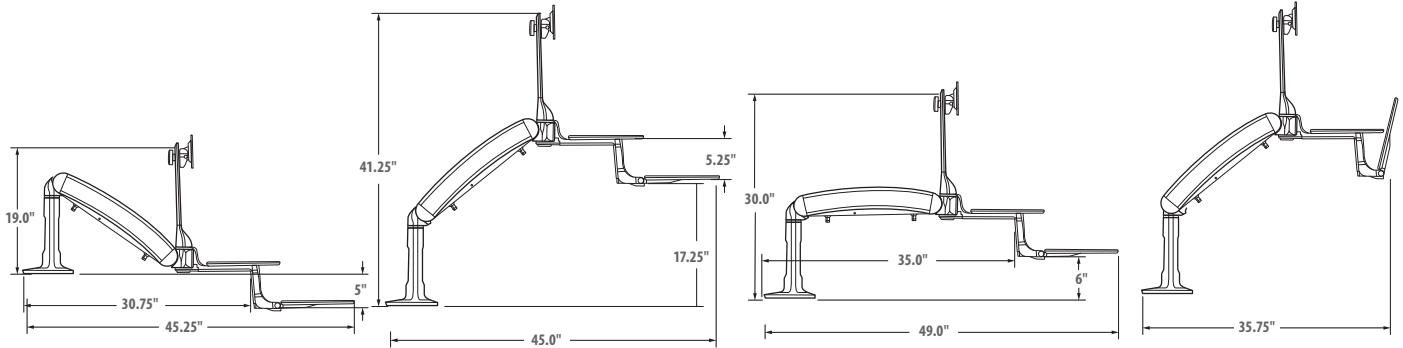
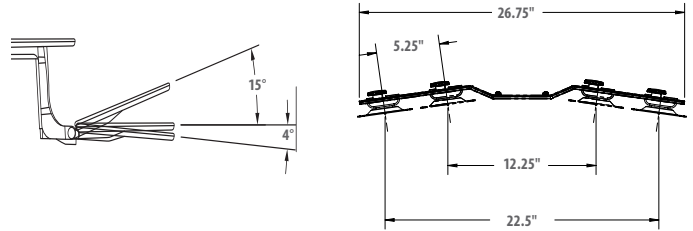

### GROMMET MOUNT

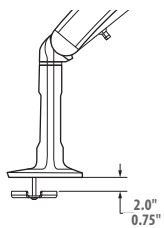

### CLAMP MOUNT

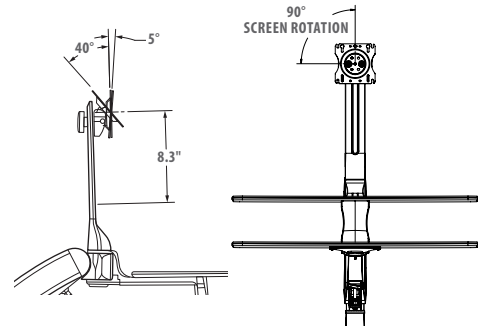
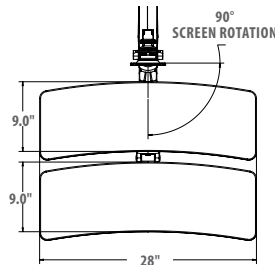
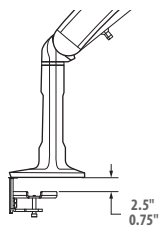

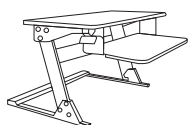

## STANDUP® X1

- Easily convert any desk into a sit/stand workstation
- 13.8" of height range accommodates a variety of users
- Keyboard tray has 20° (-10° to 10°) of tilt
- Weighs only 40 lbs
- Primary worksurface accommodates two 24" monitors
- No assembly required

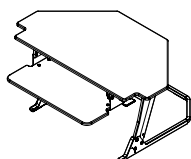
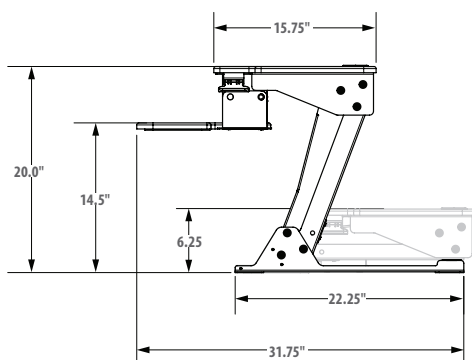

## STANDUP® X1 — CORNER

- Easily convert any desk into a sit/stand workstation
- Designed to fit 90° corner desk configurations
- 13.8" of height range accommodates a variety of users
- Keyboard tray has 20° (-10° to 10°) of tilt
- Weighs only 42 lbs
- Primary worksurface accommodates two 24" monitors
- No assembly required

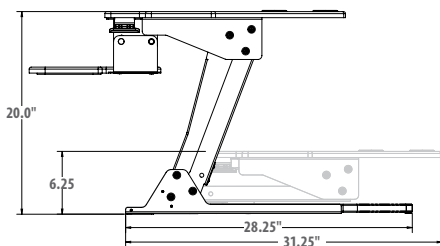

## 36" Wide — Supports up to 35 lbs

MODEL #	MECH	WORKSURFACE	LIST/L1	L2	L3
SUPX136B	Black	N/A	\$ 567	N/A	N/A
SUPX136BL	Black	Laminate	\$ 897	\$ 987	\$ 1,076
SUPX136W	White	N/A	\$ 567	N/A	N/A
SUPX136WL	White	Laminate	\$ 897	\$ 987	\$ 1,076

## 40" Wide — Supports up to 35 lbs

MODEL #	MECH	WORKSURFACE	LIST/L1	L2	L3
SUPX140BL	Black	Laminate	\$ 955	\$ 1,051	\$ 1,146
SUPX140WL	White	Laminate	\$ 975	\$ 1,073	\$ 1,170

## 42" Wide — Supports up to 45 lbs

MODEL #	MECH	WORKSURFACE	LIST/L1	L2	L3
SUPX142B	Black	N/A	\$ 975	N/A	N/A
SUPX142BL	Black	Laminate	\$ 995	\$ 1,095	\$ 1,194

## 48" Wide — Supports up to 45 lbs

MODEL #	MECH	WORKSURFACE	LIST/L1	L2	L3
SUPX148BL	Black	Laminate	\$ 1,175	\$ 1,293	\$ 1,410

## 36" Wide — Supports up to 35 lbs

MODEL #	MECH	WORKSURFACE	LIST/L1	L2	L3
SUPX1CR36BL	Black	Laminate	\$ 1,365	\$ 1,502	\$ 1,638

## 42" Wide — Supports up to 35 lbs

MODEL #	MECH	WORKSURFACE	LIST/L1	L2	L3
SUPX1CR42B	Black	N/A	\$ 995	N/A	N/A
SUPX1CR42BL	Black	Laminate	\$ 1,395	\$ 1,535	\$ 1,674

## LAMINATES FOR STANDUP X1

### L1

Ebony Starlight – Surf(x)  
Matte White – Surf(x)

3D-100  
3D-200

### L2

American Natural – Surf(x)  
Baroque – 3D  
Shaker Cherry – Surf(x)

3D-300  
3D-600  
3D-500

### L3

All other laminates from Omnova are available at L3 pricing with a minimum order of 10 StandUp X1s.

<https://www.omnova.com/product-types/laminates>

# Graded In Fabrics

## GRADED-IN AND COM UPHOLSTERY

Neutral Posture's furniture is manufactured to the highest standards. Our artisans are skilled in creating consistent finishes across all products and materials. However, the unique nature of upholstery and the other materials that are used in production means that no two pieces of furniture will be exactly alike. Fabrics will upholster differently based on composition and construction. Neutral Posture makes every effort to ensure that each item is produced to our exacting standards, but cannot be held responsible for slight variations in upholstery, color and general appearance.

Similarly, the images in our publications are as accurate as your monitor is calibrated. Customers are reminded that colors and finishes may vary according to the unique nature of each item of furniture.

Neutral Posture will not be responsible for variances in the acoustical performance of a panel due to the fact that certain fabrics perform differently from others. Additionally, Neutral Posture cannot guarantee that the graded-in fabrics will be Indoor Air Quality and/or BIFMA Level compliant. Please see the fabric manufacturer's website for these details and cleaning instructions specific to selected fabric.

For specific color matching requirements please contact the Customer Service Department.

Please note: The Finish Codes used by Neutral Posture are used as a guide to the appearance of the furniture and should not be used to determine the specific materials used in the construction of an item of furniture.

The Neutral Posture Upholstery Department is pleased to offer a Graded-in program and also accepts C.O.M. for most products. For certain items or in cases of unusual or difficult fabric patterns additional material may be required. Any unusual or special cutting requirements must be requested in writing and a full-width fabric repeat sent to the Customer Service Department in order for a quotation to be provided. The customer is responsible for shipping C.O.M. to our Upholstery Department.

CARNEGIE		
Manufacturer	Pattern	Grade
Carnegie	Abacus Embroider	H
Carnegie	Arrow X	G
Carnegie	Bardot	F
Carnegie	Buff	E
Carnegie	Cane Embroider X	Call
Carnegie	Channel	E
Carnegie	Chelsea	E
Carnegie	Cirque Couture	Call
Carnegie	Covet	D
Carnegie	Crossing	F
Carnegie	Dazzle	H
Carnegie	Departure	E
Carnegie	Edge	F
Carnegie	Elite	C
Carnegie	Groove	E
Carnegie	Hashtag	E
Carnegie	Haze X	G
Carnegie	Hepburn	F
Carnegie	Hide	E
Carnegie	Impress	E
Carnegie	Index	D
Carnegie	Keystone	E
Carnegie	Kid	E
Carnegie	Merge	F
Carnegie	Monode Embroider	I
Carnegie	Ola	Call
Carnegie	Reverie	E
Carnegie	Rise	C
Carnegie	Roxy	E
Carnegie	Tangle	F
Carnegie	Theory	E
Carnegie	Touch	C
Carnegie	Trace X	G
Carnegie	Twine	F

C.F. STINSON		
Manufacturer	Pattern	Grade
Stinson	Acclaim	C
Stinson	Aerie	D
Stinson	Ally	C
Stinson	Aperture	C
Stinson	Array	C
Stinson	Axis Too!	C
Stinson	Backdrop	C
Stinson	Binary	D
Stinson	Code	B
Stinson	Dapple	C
Stinson	Del Mar	C
Stinson	Focus	C
Stinson	Galaxy	D
Stinson	Genesis	B
Stinson	Imprint	C
Stinson	Intermix	C
Stinson	Linea	E
Stinson	Lulu	C
Stinson	Luther II	C
Stinson	Mason	C
Stinson	Mira	C
Stinson	Nikko	C
Stinson	Prime	B
Stinson	Repetition	C
Stinson	Ringer	C
Stinson	Sight Line	C
Stinson	Spree	C
Stinson	Surf	B
Stinson	Tally	D
Stinson	Tussah	C
Stinson	Venture	C

DESIGNTEX			KNOLLTEXTILES			GUILFORD OF MAINE		
Manufacturer	Pattern	Grade	Manufacturer	Pattern	Grade	Manufacturer	Pattern	Grade
Designtex	Appleseed	F	KnollTextiles	Alignment	F	Guilford of Maine	Anchorage	B
Designtex	Arne	E	KnollTextiles	Amplify	F	Guilford of Maine	Auster	B
Designtex	Billiard	E	KnollTextiles	Annex	E	Guilford of Maine	Axiom	B
Designtex	Birdseye	C	KnollTextiles	Bandwidth	F	Guilford of Maine	Bailey	B
Designtex	Brushed Flannel	E	KnollTextiles	Beacon	C	Guilford of Maine	Basketweave	C
Designtex	Bubble Wrap	E	KnollTextiles	Broadcloth II	E	Guilford of Maine	Beacon (54" bolt)	B
Designtex	Cesta	D	KnollTextiles	Cable Twist	E	Guilford of Maine	BeeHave (54" bolt)	B
Designtex	Chiyogami	G	KnollTextiles	Circle Line	E	Guilford of Maine	Birdseye	B
Designtex	Chromatic	E	KnollTextiles	Circuit	D	Guilford of Maine	Bix	B
Designtex	Clew	E	KnollTextiles	Clarity	E	Guilford of Maine	Block Party	C
Designtex	Cloud Velvet	E	KnollTextiles	Criss Cross	E	Guilford of Maine	Broadcast	B
Designtex	Crossweave	E	KnollTextiles	Crossroad	E	Guilford of Maine	Cape Cod	B
Designtex	Decibel	E	KnollTextiles	Delite	C	Guilford of Maine	Coastline	B
Designtex	Ellipsis	D	KnollTextiles	Dristi	F	Guilford of Maine	Couture (54" bolt)	B
Designtex	Everywhere Texture	E	KnollTextiles	Edo	D	Guilford of Maine	Crossings	B
Designtex	Gamut	D	KnollTextiles	Element	E	Guilford of Maine	Crosstown	B
Designtex	Gravity	D	KnollTextiles	Foil Rap	F	Guilford of Maine	Dashing	B
Designtex	Gridley	E	KnollTextiles	Growth Spurt	E	Guilford of Maine	Digit	B
Designtex	Hem Stitch	E	KnollTextiles	Hard Rock	F	Guilford of Maine	Drift	C
Designtex	Kabuto	G	KnollTextiles	Heavy Metal	F	Guilford of Maine	Essence	A
Designtex	Melange	E	KnollTextiles	Hourglass	E	Guilford of Maine	FR701®	B
Designtex	Minnie	D	KnollTextiles	Knoll Felt	F	Guilford of Maine	Framework	B
Designtex	New Brunswick	C	KnollTextiles	Knoll Hopsack	F	Guilford of Maine	Galaxy	C
Designtex	Ori	G	KnollTextiles	Logic	E	Guilford of Maine	Groove	C
Designtex	Otto	F	KnollTextiles	Macro	F	Guilford of Maine	Hatchet	B
Designtex	Pick Up Sticks	E	KnollTextiles	Mainframe	E	Guilford of Maine	Highbeams (54" bolt)	A
Designtex	Plateau	D	KnollTextiles	Match Point	E	Guilford of Maine	Intermix	B
Designtex	Reppeweave	E	KnollTextiles	Messa	D	Guilford of Maine	Intuition (54" bolt)	C
Designtex	Rocket	E	KnollTextiles	Mezzo	F	Guilford of Maine	Jane (54" bolt)	B
Designtex	Twist	E	KnollTextiles	Micro	F	Guilford of Maine	Lido	B
Designtex	Ulster	C	KnollTextiles	Monarch	F	Guilford of Maine	Meander	B
Designtex	Union Cloth	E	KnollTextiles	Nematic II	E	Guilford of Maine	Metallation	B
Designtex	US Rain State Farm	E	KnollTextiles	Palladium	F	Guilford of Maine	Metro	B
Designtex	Velocity	E	KnollTextiles	Photon II	E	Guilford of Maine	Mingle	B
Designtex	Vivid	D	KnollTextiles	Pivot	C	Guilford of Maine	Network	C
			KnollTextiles	Presto	E	Guilford of Maine	Otto	B
			KnollTextiles	Ransom	F	Guilford of Maine	Paradise	B
			KnollTextiles	Reflect	E	Guilford of Maine	Parameter	B
			KnollTextiles	Relay	F	Guilford of Maine	Phone Tag	C
			KnollTextiles	Skylark	D	Guilford of Maine	Pursuit	A
			KnollTextiles	Symbolic Details	E	Guilford of Maine	Quadrille (54" bolt)	B
			KnollTextiles	Tailor Made II	E	Guilford of Maine	Rattan	C
			KnollTextiles	Twister	D	Guilford of Maine	Reeds	B
			KnollTextiles	Versatility	E	Guilford of Maine	Regatta	C
			KnollTextiles	Wonder	D	Guilford of Maine	Sand	C
			KnollTextiles	Zenith	E	Guilford of Maine	Spinel	B
						Guilford of Maine	Sprite	B
						Guilford of Maine	Strata	B
						Guilford of Maine	Streetwise	C
						Guilford of Maine	Studio 54	C
						Guilford of Maine	Synopsis (54" bolt)	B
						Guilford of Maine	Tempest	C
						Guilford of Maine	Theory	B
						Guilford of Maine	Tweed	B
						Guilford of Maine	Twigs	B
						Guilford of Maine	Vertical Surface Blends	C
						Guilford of Maine	Vertical Surface Solids	C
						Guilford of Maine	Vortex	B
						Guilford of Maine	Whisper	B

# Graded In Fabrics

LUNA			MAHARAM			MAYER		
Manufacturer	Pattern	Grade	Manufacturer	Pattern	Grade	Manufacturer	Pattern	Grade
Luna	Affinity	G	Maharam	Crisp	E	Mayer	Anasazi	C
Luna	Aspect	G	Maharam	Field	E	Mayer	Basic	A
Luna	Facet	G	Maharam	Flock	E	Mayer	Blueprint	A
Luna	Freehand	E	Maharam	Glance	E	Mayer	Cipher	A
Luna	Halo	E	Maharam	Glint	E	Mayer	Code	A
Luna	Hammered Metal	E	Maharam	Hum	E	Mayer	Copa	B
Luna	Idyll	E	Maharam	Morse	E	Mayer	Cross Check	A
Luna	Incandescent	E	Maharam	Parallel	E	Mayer	Echo	D
Luna	Intersect	E	Maharam	Reply	E	Mayer	Equal	B
Luna	Linea	D	Maharam	Sharkskin 2	F	Mayer	Flair	C
Luna	Luminescence	E	Maharam	Sketch	E	Mayer	Forte	A
Luna	Quad	E	Maharam	Spiral	E	Mayer	Fresco	B
Luna	Radar	E	Maharam	Unit	E	Mayer	Graph	A
Luna	Signal	E				Mayer	Grasscloth	B
Luna	Sonic	E				Mayer	Gridline	C
Luna	Stepping Stones	E				Mayer	Interlude	B
Luna	Stitch	E				Mayer	Luminary	B
Luna	Transmission	E				Mayer	Melange	C
Luna	Twiggy	H				Mayer	Multi-Crepe	B
Luna	Twist	E				Mayer	Nexus	B
						Mayer	Paragon	C
						Mayer	Pebble Beach	B
						Mayer	Quattro	B
						Mayer	Rain Drops	C
						Mayer	Reverb	C
						Mayer	Space Odyssey	C
						Mayer	Spectre	C
						Mayer	Strata	B
						Mayer	Terrain	C
						Mayer	Whirlwind	B
						Mayer	Zest	B



<b>MOMENTUM</b>		
<b>Manufacturer</b>	<b>Pattern</b>	<b>Grade</b>
Momentum	Alpha	B
Momentum	Backdrop	B
Momentum	Cameo	B
Momentum	Curtain Call	B
Momentum	Edict	B
Momentum	Encore	B
Momentum	Extend	B
Momentum	Inlay	C
Momentum	Meander	B
Momentum	Overture	A
Momentum	Pact	A
Momentum	Saga	B
Momentum	Tenor	A
Momentum	Universe	B
Momentum	Verse	A



---

## LEGACY TABLE OF CONTENTS

---

---

### LEGACY FINISHES ..... 164

Laminate .....	164
Edge Band .....	164
Paint .....	165
Plexiglass .....	165
Fabric .....	165

---

### GEN 1 & 2 PANELS ..... 166

---

#### GEN 1 ..... 166

Fabric Panels .....	166 – 167
---------------------	-----------

---

#### GEN 2 ..... 168

Insert Panels .....	168 – 169
Wall Starter & Wall Mount Chanel .....	170

---

#### POST ASSEMBLIES ..... 171

Straight .....	171
Corner (90°) .....	171
End .....	171
3-way (T) .....	172
3-way (Y) .....	172
4-way (X) .....	172
Dual Height Posts .....	173
Triple Height Posts .....	174
Single Height Posts .....	175
Panel Connectors .....	176
Panel Extender Kit .....	177

---

### GEN 3 ..... 178

Fabric Panels .....	178
Insert Panels .....	179

---

#### POST ASSEMBLIES ..... 180

Straight .....	180
2-way (L) .....	180
2-way (120) .....	180
3-way (T) .....	180
3-way (120) .....	180
4-way (X) .....	180
Single Height .....	181
Dual Height .....	181
Triple Height .....	181
End Kits .....	182
Wall Starter/Wall Mounted Channel .....	183

---

#### PANEL ACCESSORIES ..... 184

Vertical Wire Manager .....	184
Metal Ceiling Module .....	184
Coat Hook .....	185
Carpet Gripper .....	185

---

#### COUNTER CAPS ..... 186

Straights .....	186
Corners .....	187

---

#### FREESTANDING ..... 188

Flat Brackets .....	188
Column Base .....	188
Tackable Privacy .....	189

---

### WALL MOUNTING ..... 190

Wall Mounting Suggestions .....	191
---------------------------------	-----

---

### KEY LOCK PROGRAM ..... 192

General Information .....	192
How to Specify Key Alike .....	192
Key-alike ordered prior to 6/12/00 .....	193

---

**Legacy finishes are only available for existing customers to match existing installs**

---

### LAMINATES

---

#### L1

Jet Black	111
Folkstone Grey (was LA)	114
Soft Grey (was M42)	117
Bright White	118
Pumice (was LF)	119
Micro Grey	121
Brushed Sand	122
Brushed Grey	123
Medium Cherry	124
Natural Maple	125
Natural Cherry	126
Walnut	127
Fog	128
Micro Sand	129
Caramel Maple	MC
Clear Maple	CM
Deep Mahogany	MP58
Grey Granite	M95
Light Oak	MP70
Pearwood	PA
Rose Granite	M96
Sand	SD
Med. Grey (Slate)	M89
Taupe	M80
Warm Cherry	WM
White Essence	ES7
Winter Grey Matrix	MR6

---

### EDGE BANDS

---

Jet Black	111
Dark Grey (was Y3)	113
Folkstone Grey (was LA)	114
Medium Grey (was Y2)	115
Soft Grey (was E)	117
Bright White	118
Pumice (was LF)	119
Medium Cherry	124
Natural Maple	125
Natural Cherry	126
Walnut	127
Fog	128
Dark Neutral	D
Taupe	R
Sand	SD
Caramel Maple	MC
Clear Maple	CM

**NOTE: Laminates and other finishes may vary in color due to different dye lots. Slight variations are normal.**

## PAINTS & PLASTICS

### P1

Jet Black	111
Brown	112
Dark Grey (was Y3)	113
Folkstone Grey (was LA)	114
Med. Grey (was Y2)	115
Sandstone	116
Soft Grey (was E)	117
Dark Neutral	D
Taupe	R

### P2

Beige Mist Metallic	611
Medium Metallic Grey	612
Beige Metallic	H
Light Tan Metallic	W

### P3

Bright White	118
Silver	613

**NOTE: EP1 and EP2 panels and components are not available in the following:**

Bright White	118
Brown	112
Jet Black	111

## PLEXIGLASS

Clear	CL
Ice	IC
Smoked	SM
Translucent	TR

### NOT AVAILABLE ON INSERT PANELS

Frost	LF
-------	----

## FABRICS

### E

Annex	KnollTextiles	W1360
Circle Line	KnollTextiles	W1146
Criss Cross	KnollTextiles	W305
Growth Spurt	KnollTextiles	W692
Photon II	KnollTextiles	W1293
Reflect	KnollTextiles	W884
Symbolic Detail	KnollTextiles	W693
Versatility	KnollTextiles	W432

### F

Amplify	KnollTextiles	W1215
Foil Rap	KnollTextiles	W535
Hard Rock	KnollTextiles	W1007
Heavy Metal	KnollTextiles	W539
Micro	KnollTextiles	W465
Relay	KnollTextiles	W1020

**NOTE: All 72 privacy screens require that the textile is railroaded (turned 90 degrees) for application. This must be considered when applying a patterned textile.**

# Generation 1 Fabric Panel

28" thru 48" High

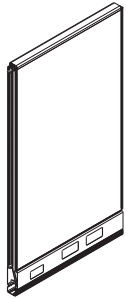

## 28" H

W	MODEL #	A	B	C	D	E	F	G	PAINT	
									P2	P3
12"	EP1FA1228R	\$654	\$706	\$722	\$739	\$752	\$765	\$784	N/A	+ \$50
18"	EP1FA1828R	\$681	\$735	\$749	\$767	\$779	\$797	\$815	N/A	+ \$50
24"	EP1FA2428R	\$705	\$763	\$776	\$798	\$811	\$825	\$849	N/A	+ \$50
30"	EP1FA3028R	\$726	\$780	\$798	\$819	\$835	\$850	\$872	N/A	+ \$50
36"	EP1FA3628R	\$759	\$818	\$834	\$855	\$873	\$886	\$910	N/A	+ \$50
42"	EP1FA4228R	\$792	\$853	\$872	\$894	\$912	\$925	\$947	N/A	+ \$50
48"	EP1FA4828R	\$820	\$887	\$901	\$927	\$944	\$961	\$986	N/A	+ \$50
60"	EP1FA6028R	\$874	\$941	\$960	\$988	\$1,004	\$1,019	\$1,047	N/A	+ \$50

## 40" H

12"	EP1FA1240R	\$687	\$740	\$756	\$776	\$789	\$804	\$821	N/A	+ \$50
18"	EP1FA1840R	\$720	\$776	\$792	\$811	\$825	\$840	\$860	N/A	+ \$50
24"	EP1FA2440R	\$752	\$811	\$827	\$851	\$865	\$881	\$901	N/A	+ \$50
30"	EP1FA3040R	\$775	\$838	\$852	\$877	\$892	\$907	\$929	N/A	+ \$50
36"	EP1FA3640R	\$800	\$865	\$881	\$904	\$922	\$936	\$961	N/A	+ \$50
42"	EP1FA4240R	\$893	\$962	\$982	\$1,007	\$1,027	\$1,043	\$1,073	N/A	+ \$50
48"	EP1FA4840R	\$921	\$995	\$1,010	\$1,039	\$1,056	\$1,076	\$1,101	N/A	+ \$50
60"	EP1FA6040R	\$1,034	\$1,117	\$1,136	\$1,168	\$1,189	\$1,208	\$1,242	N/A	+ \$50

## 48" H

12"	EP1FA1248R	\$706	\$764	\$777	\$799	\$812	\$827	\$850	N/A	+ \$50
18"	EP1FA1848R	\$741	\$801	\$815	\$839	\$853	\$872	\$892	N/A	+ \$50
24"	EP1FA2448R	\$812	\$879	\$895	\$912	\$935	\$953	\$973	N/A	+ \$50
30"	EP1FA3048R	\$836	\$901	\$921	\$944	\$961	\$978	\$1,004	N/A	+ \$50
36"	EP1FA3648R	\$848	\$915	\$930	\$956	\$970	\$989	\$1,014	N/A	+ \$50
42"	EP1FA4248R	\$941	\$1,016	\$1,037	\$1,063	\$1,083	\$1,101	\$1,130	N/A	+ \$50
48"	EP1FA4848R	\$1,004	\$1,083	\$1,101	\$1,133	\$1,154	\$1,173	\$1,204	N/A	+ \$50
60"	EP1FA6048R	\$1,141	\$1,235	\$1,256	\$1,288	\$1,312	\$1,335	\$1,370	N/A	+ \$50

Order Code	
e.g.	EP1FA3648R, W3513, 117
EP1FA	Fabric panel
36	Width
48	Height
R	Raceway
W351-3	Foundation, Corn Silk
117	Soft Grey trim

Specification Information	
Specify fabric and trim color. Post assemblies or connection elements must be ordered separately.	Electrical components must be ordered separately.
<b>NOTE: Power duplexes cannot be installed on 12" W panels. Side mount receptacles available in 24" W panels and wider while using "E" series power.</b>	<b>NOTE: P2 trim colors are not available on EP1 panels and panel components.</b>

Application Notes
Panel is fabric covered. If two different fabrics are used on one panel, price will reflect cost of the more expensive panel fabric.
<b>NOTE: EP1 &amp; EP2 Panels and components are available in legacy colors only.</b>

# Generation 1 fabric panel

53" thru 80" High



## 53" H

W	MODEL #	A	B	C	D	E	F	G	PAINT	
									P2	P3
12"	EP1FA1253R	\$724	\$778	\$796	\$814	\$829	\$844	\$868	N/A	+ \$50
18"	EP1FA1853R	\$760	\$819	\$835	\$856	\$874	\$887	\$912	N/A	+ \$50
24"	EP1FA2453R	\$801	\$868	\$884	\$907	\$923	\$937	\$962	N/A	+ \$50
30"	EP1FA3053R	\$821	\$889	\$904	\$930	\$946	\$962	\$988	N/A	+ \$50
36"	EP1FA3653R	\$946	\$1,021	\$1,042	\$1,073	\$1,088	\$1,109	\$1,136	N/A	+ \$50
42"	EP1FA4253R	\$989	\$1,069	\$1,088	\$1,118	\$1,136	\$1,158	\$1,187	N/A	+ \$50
48"	EP1FA4853R	\$1,045	\$1,129	\$1,150	\$1,182	\$1,202	\$1,222	\$1,254	N/A	+ \$50
60"	EP1FA6053R	\$1,187	\$1,282	\$1,305	\$1,340	\$1,365	\$1,389	\$1,424	N/A	+ \$50

## 60" H

12"	EP1FA1260R	\$740	\$800	\$814	\$838	\$852	\$868	\$889	N/A	+ \$50
18"	EP1FA1860R	\$784	\$849	\$863	\$886	\$899	\$918	\$941	N/A	+ \$50
24"	EP1FA2460R	\$800	\$865	\$881	\$904	\$922	\$936	\$961	N/A	+ \$50
30"	EP1FA3060R	\$885	\$956	\$970	\$1,002	\$1,016	\$1,036	\$1,058	N/A	+ \$50
36"	EP1FA3660R	\$966	\$1,043	\$1,061	\$1,091	\$1,113	\$1,130	\$1,160	N/A	+ \$50
42"	EP1FA4260R	\$1,053	\$1,136	\$1,160	\$1,190	\$1,209	\$1,231	\$1,263	N/A	+ \$50
48"	EP1FA4860R	\$1,137	\$1,230	\$1,251	\$1,285	\$1,308	\$1,330	\$1,368	N/A	+ \$50
60"	EP1FA6060R	\$1,307	\$1,413	\$1,438	\$1,477	\$1,503	\$1,529	\$1,569	N/A	+ \$50

## 65" H

12"	EP1FA1265R	\$779	\$844	\$858	\$884	\$897	\$916	\$936	N/A	+ \$50
18"	EP1FA1865R	\$799	\$862	\$880	\$901	\$921	\$933	\$959	N/A	+ \$50
24"	EP1FA2465R	\$895	\$967	\$986	\$1,010	\$1,032	\$1,047	\$1,075	N/A	+ \$50
30"	EP1FA3065R	\$947	\$1,024	\$1,043	\$1,074	\$1,091	\$1,110	\$1,137	N/A	+ \$50
36"	EP1FA3665R	\$1,007	\$1,088	\$1,110	\$1,138	\$1,160	\$1,179	\$1,208	N/A	+ \$50
42"	EP1FA4265R	\$1,098	\$1,189	\$1,208	\$1,243	\$1,264	\$1,285	\$1,321	N/A	+ \$50
48"	EP1FA4865R	\$1,190	\$1,284	\$1,308	\$1,343	\$1,369	\$1,393	\$1,428	N/A	+ \$50
60"	EP1FA6065R	\$1,374	\$1,483	\$1,513	\$1,554	\$1,579	\$1,608	\$1,650	N/A	+ \$50

## 80" H

12"	EP1FA1280R	\$795	\$855	\$873	\$895	\$913	\$927	\$953	N/A	+ \$50
18"	EP1FA1880R	\$844	\$913	\$929	\$955	\$969	\$988	\$1,012	N/A	+ \$50
24"	EP1FA2480R	\$899	\$971	\$992	\$1,018	\$1,037	\$1,054	\$1,080	N/A	+ \$50
30"	EP1FA3080R	\$1,010	\$1,091	\$1,115	\$1,143	\$1,163	\$1,183	\$1,212	N/A	+ \$50
36"	EP1FA3680R	\$1,128	\$1,215	\$1,240	\$1,276	\$1,297	\$1,319	\$1,352	N/A	+ \$50
42"	EP1FA4280R	\$1,242	\$1,340	\$1,365	\$1,401	\$1,428	\$1,452	\$1,488	N/A	+ \$50
48"	EP1FA4880R	\$1,352	\$1,460	\$1,486	\$1,528	\$1,555	\$1,581	\$1,621	N/A	+ \$50
60"	EP1FA6080R	\$1,577	\$1,701	\$1,734	\$1,782	\$1,814	\$1,844	\$1,893	N/A	+ \$50

Order Code	
e.g.	EP1FA2460R, W3513, 117
EP1FA	Fabric panel
24	Width
60	Height
W351-3	Foundation, Corn Silk
117	Soft Grey trim

Specification Information	
Specify fabric and trim color.	Electrical components must be ordered separately.
Post assemblies or connection elements must be ordered separately.	<b>NOTE: P2 trim colors are not available on EP1 panels and panel components.</b>
<b>NOTE: Power duplexes cannot be installed on 12" W panels. Side mount receptacles available in 24" W panels and wider while using "E" series power.</b>	

Application Notes
Panel is fabric covered. If two different fabrics are used on one panel, price will reflect cost of the more expensive panel fabric.
<b>NOTE: EP1 &amp; EP2 Panels and components are available in legacy colors only.</b>

Pricing is for P1 paint trim colors. Add the appropriate upcharge if using P2 or P3 trim.

# Generation 2 Insert Panel

(compatible with generation 1 panel components only)



## 28" H

W	MODEL #	OPEN FRAME (OF)	PLEXIGLASS (PG)*	PAINT	
				P2	P3
12"	EP2( )1228R	\$697	\$936	N/A	+ \$50
18"	EP2( )1828R	\$711	\$1,004	N/A	+ \$50
24"	EP2( )2428R	\$725	\$1,058	N/A	+ \$50
30"	EP2( )3028R	\$740	\$1,121	N/A	+ \$50
36"	EP2( )3628R	\$759	\$1,174	N/A	+ \$50
42"	EP2( )4228R	\$778	\$1,269	N/A	+ \$50
48"	EP2( )4828R	\$797	\$1,293	N/A	+ \$50
60"	EP2( )6028R	\$834	\$1,408	N/A	+ \$50

## 40" H

12"	EP2( )1240R	\$736	\$1,028	N/A	+ \$50
18"	EP2( )1840R	\$751	\$1,090	N/A	+ \$50
24"	EP2( )2440R	\$763	\$1,154	N/A	+ \$50
30"	EP2( )3040R	\$779	\$1,270	N/A	+ \$50
36"	EP2( )3640R	\$797	\$1,430	N/A	+ \$50
42"	EP2( )4240R	\$818	\$1,460	N/A	+ \$50
48"	EP2( )4840R	\$836	\$1,481	N/A	+ \$50
60"	EP2( )6040R	\$874	\$1,632	N/A	+ \$50

## 48" H

12"	EP2( )1248R	\$751	\$1,057	N/A	+ \$50
18"	EP2( )1848R	\$766	\$1,165	N/A	+ \$50
24"	EP2( )2448R	\$777	\$1,248	N/A	+ \$50
30"	EP2( )3048R	\$797	\$1,359	N/A	+ \$50
36"	EP2( )3648R	\$811	\$1,382	N/A	+ \$50
42"	EP2( )4248R	\$834	\$1,522	N/A	+ \$50
48"	EP2( )4848R	\$852	\$1,802	N/A	+ \$50
60"	EP2( )6048R	\$887	\$1,821	N/A	+ \$50

## 53" H

12"	EP2( )1253R	\$776	\$1,091	N/A	+ \$50
18"	EP2( )1853R	\$792	\$1,197	N/A	+ \$50
24"	EP2( )2453R	\$800	\$1,279	N/A	+ \$50
30"	EP2( )3053R	\$820	\$1,393	N/A	+ \$50
36"	EP2( )3653R	\$836	\$1,484	N/A	+ \$50
42"	EP2( )4253R	\$857	\$1,648	N/A	+ \$50
48"	EP2( )4853R	\$877	\$1,669	N/A	+ \$50
60"	EP2( )6053R	\$915	\$1,854	N/A	+ \$50

\* All Colors

Order Code	
e.g.	EP2PG3648R, PC, 613
EP2PG	Plexiglass Insert Panel
36	Width
48	Height
R	Raceway
PC	Clear
613	Silver trim

### Specification Information

Specify insert type, insert color and trim color.

### Application Notes

Top caps and base raceway covers are included with panels. Posts and panel connectors must be ordered separately.

**NOTE: P2 trim colors are not available on EP2 panels or panel components.**

Generation 2 insert panels incorporate the generation 3 mitered panel frame with generation 1 top caps and base raceway covers and will only work with generation 1 panels and panel components.

**NOTE: EP1 & EP2 Panels and components are available in legacy colors only.**



# Generation 2 Insert Panel

(compatible with generation 1 panel components only)

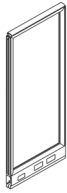

## 60" H

W	MODEL #	OPEN FRAME (OF)	PLEXIGLASS (PG)*	PAINT	
				P2	P3
12"	EP2( )1260R	\$784	\$1,129	N/A	+ \$50
18"	EP2( )1860R	\$799	\$1,251	N/A	+ \$50
24"	EP2( )2460R	\$810	\$1,379	N/A	+ \$50
30"	EP2( )3060R	\$827	\$1,518	N/A	+ \$50
36"	EP2( )3660R	\$844	\$1,539	N/A	+ \$50
42"	EP2( )4260R	\$868	\$1,679	N/A	+ \$50
48"	EP2( )4860R	\$884	\$1,816	N/A	+ \$50
60"	EP2( )6060R	\$921	\$2,036	N/A	+ \$50

## 65" H

12"	EP2( )1265R	\$797	\$1,143	N/A	+ \$50
18"	EP2( )1865R	\$811	\$1,267	N/A	+ \$50
24"	EP2( )2465R	\$821	\$1,413	N/A	+ \$50
30"	EP2( )3065R	\$839	\$1,535	N/A	+ \$50
36"	EP2( )3665R	\$857	\$1,555	N/A	+ \$50
42"	EP2( )4265R	\$879	\$1,695	N/A	+ \$50
48"	EP2( )4865R	\$895	\$2,076	N/A	+ \$50
60"	EP2( )6065R	\$930	\$2,115	N/A	+ \$50

## 80" H

12"	EP2( )1280R	\$851	\$1,304	N/A	+ \$50
18"	EP2( )1880R	\$868	\$1,446	N/A	+ \$50
24"	EP2( )2480R	\$877	\$1,576	N/A	+ \$50
30"	EP2( )3080R	\$894	\$1,825	N/A	+ \$50
36"	EP2( )3680R	\$913	\$1,983	N/A	+ \$50
42"	EP2( )4280R	\$930	\$2,287	N/A	+ \$50
48"	EP2( )4880R	\$948	\$2,308	N/A	+ \$50
60"	EP2( )6080R	\$988	\$2,625	N/A	+ \$50

\* All Colors

Order Code	
e.g.	EP2PG2460R, 613
EP2PG	Plexiglass Insert Panel
24	Width
60	Height
R	Raceway
613	Silver trim

Specification Information	
Specify insert type, insert color and trim color.	<b>NOTE: P2 trim colors are not available on EP2 panels or panel components.</b>
Top caps and base raceway covers are included with panels. Posts and panel connectors must be ordered separately.	

Application Notes
Generation 2 insert panels incorporate the generation 3 mitered panel frame with generation 1 top caps and base raceway covers and will only work with generation 1 panels and panel components.
<b>NOTE: EP1 &amp; EP2 Panels and components are available in legacy colors only.</b>

# Generation 1

wall starter and wall mount channel



## Panel Wall Starter

W	D	H*	ACTUAL HEIGHT	MODEL #	P1	P2	P3
1½"	½"	28"	23"	EP1PWS28	\$44	N/A	\$48
1½"	½"	40"	35"	EP1PWS40	\$44	N/A	\$48
1½"	½"	48"	43"	EP1PWS48	\$48	N/A	\$52
1½"	½"	53"	48"	EP1PWS53	\$50	N/A	\$56
1½"	½"	60"	55"	EP1PWS60	\$50	N/A	\$56
1½"	½"	65"	60"	EP1PWS65	\$52	N/A	\$59
1½"	½"	80"	75"	EP1PWS80	\$59	N/A	\$69



## Wall Mounted Channel

2⅞"	¾"	28"	23"	EP1WMC28	\$112	N/A	\$122
2⅞"	¾"	40"	35"	EP1WMC40	\$112	N/A	\$122
2⅞"	¾"	48"	43"	EP1WMC48	\$114	N/A	\$124
2⅞"	¾"	53"	48"	EP1WMC53	\$116	N/A	\$128
2⅞"	¾"	60"	55"	EP1WMC60	\$130	N/A	\$145
2⅞"	¾"	65"	60"	EP1WMC65	\$133	N/A	\$150
2⅞"	¾"	80"	75"	EP1WMC80	\$162	N/A	\$178
2⅞"	¾"	120"	120"	EP1WMC120	\$249	N/A	\$276

\* - actual height

Order Code
e.g. EP1PWS60, 117
EP1PWS Panel wall starter
60 Height
117 Soft Grey trim

Specification Information
Specify trim color.
<b>NOTE: Neutral Posture, Inc. assumes no responsibility for wall construction or performance of fasteners used.</b>

Application Notes
<p><b>Wall starter:</b> Used to start a run of panels by fastening to an existing wall and attaching a connector assembly to it. Creates 1¼" space from face of wall to centerline of post. Constructed of steel.</p> <p>The wall starter includes panel top and bottom hooks and modified panel connector. Fasteners not included to attach to wall.</p> <p>Post and shrouds must</p>
<p>be ordered separately.</p> <p><b>Wall mount channel:</b> Allows hanging of all components and accessories on reinforced building walls.</p> <p>Painted extruded aluminum with a plastic inset which snaps in place, covering mounting screws.</p> <p><b>NOTE: EP1 &amp; EP2 Panels and components are available in legacy colors only.</b></p>



## Straight

W	D	H	MODEL #	P1	P2	P3
-	-	28"	EP1P28S	\$148	N/A	\$164
-	-	40"	EP1P40S	\$150	N/A	\$165
-	-	48"	EP1P48S	\$152	N/A	\$166
-	-	53"	EP1P53S	\$154	N/A	\$168
-	-	60"	EP1P60S	\$156	N/A	\$170
-	-	65"	EP1P65S	\$157	N/A	\$172
-	-	80"	EP1P80S	\$161	N/A	\$177



## Corner (90°)

-	-	28"	EP1P28L	\$144	N/A	\$156
-	-	40"	EP1P40L	\$145	N/A	\$157
-	-	48"	EP1P48L	\$146	N/A	\$161
-	-	53"	EP1P53L	\$148	N/A	\$164
-	-	60"	EP1P60L	\$150	N/A	\$165
-	-	65"	EP1P65L	\$152	N/A	\$166
-	-	80"	EP1P80L	\$156	N/A	\$170



## End

-	-	28"	EP1P28E	\$157	N/A	\$172
-	-	40"	EP1P40E	\$159	N/A	\$174
-	-	48"	EP1P48E	\$161	N/A	\$177
-	-	53"	EP1P53E	\$162	N/A	\$178
-	-	60"	EP1P60E	\$164	N/A	\$179
-	-	65"	EP1P65E	\$165	N/A	\$183
-	-	80"	EP1P80E	\$167	N/A	\$187

Order Code	
e.g.	EP1P48S, 117
EP1P	Post
48	Height
S	Straight assembly
117	Soft Grey trim

**Specification Information**  
Specify trim color.

**Application Notes**  
Used to connect panels of the same height.  
Kit includes single height post, panel connector and base raceway shroud(s) appropriate for the geometry specified.  
**NOTE: EP1 & EP2 Panels and components are available in legacy colors only.**  
Bottom levelers on post allow for up to 1½" vertical adjustment.

# Generation 1

single height post assemblies three and four way



## 3-way (T)

W	D	H	MODEL #	P1	P2	P3
-	-	28"	EP1P28T	\$144	N/A	\$156
-	-	40"	EP1P40T	\$145	N/A	\$157
-	-	48"	EP1P48T	\$146	N/A	\$161
-	-	53"	EP1P53T	\$148	N/A	\$164
-	-	60"	EP1P60T	\$150	N/A	\$165
-	-	65"	EP1P65T	\$152	N/A	\$166
-	-	80"	EP1P80T	\$156	N/A	\$170



## 3-way (Y)

-	-	28"	EP1P28Y	\$179	N/A	\$201
-	-	40"	EP1P40Y	\$183	N/A	\$202
-	-	48"	EP1P48Y	\$185	N/A	\$203
-	-	53"	EP1P53Y	\$186	N/A	\$205
-	-	60"	EP1P60Y	\$187	N/A	\$206
-	-	65"	EP1P65Y	\$190	N/A	\$208
-	-	80"	EP1P80Y	\$192	N/A	\$208



## 4-way (X)

-	-	28"	EP1P28X	\$124	N/A	\$136
-	-	40"	EP1P40X	\$128	N/A	\$141
-	-	48"	EP1P48X	\$129	N/A	\$144
-	-	53"	EP1P53X	\$130	N/A	\$145
-	-	60"	EP1P60X	\$131	N/A	\$146
-	-	65"	EP1P65X	\$132	N/A	\$147
-	-	80"	EP1P80X	\$135	N/A	\$150

Order Code	
e.g.	EP1P80T, 117
EP1P	Post
80	Height
T	"T" assembly
117	Soft Grey trim

**Specification Information**  
Specify trim color

### Application Notes

Used to connect panels of the same height.

Kit includes single height post, panel connector and base raceway shroud(s) appropriate for the geometry specified.

**NOTE: EP1 & EP2 Panels and components are available in legacy colors only.**

Bottom levelers on post allow for up to 1½" vertical adjustment.



### Dual Height Post

W	D	H	MODEL #	P1	P2	P3
-	-	28"/40"	EP1DP2840	\$154	N/A	\$168
-	-	28"/48"	EP1DP2848	\$164	N/A	\$179
-	-	28"/53"	EP1DP2853	\$167	N/A	\$187
-	-	28"/60"	EP1DP2860	\$170	N/A	\$190
-	-	28"/65"	EP1DP2865	\$177	N/A	\$193
-	-	28"/80"	EP1DP2880	\$193	N/A	\$215
-	-	40"/48"	EP1DP4048	\$164	N/A	\$179
-	-	40"/53"	EP1DP4053	\$167	N/A	\$187
-	-	40"/60"	EP1DP4060	\$170	N/A	\$190
-	-	40"/65"	EP1DP4065	\$177	N/A	\$193
-	-	40"/80"	EP1DP4080	\$193	N/A	\$215
-	-	48"/53"	EP1DP4853	\$167	N/A	\$187
-	-	48"/60"	EP1DP4860	\$170	N/A	\$190
-	-	48"/65"	EP1DP4865	\$177	N/A	\$193
-	-	48"/80"	EP1DP4880	\$193	N/A	\$215
-	-	53"/60"	EP1DP5360	\$170	N/A	\$190
-	-	53"/65"	EP1DP5365	\$177	N/A	\$193
-	-	53"/80"	EP1DP5380	\$199	N/A	\$219
-	-	60"/65"	EP1DP6065	\$177	N/A	\$193
-	-	60"/80"	EP1DP6080	\$193	N/A	\$215
-	-	65"/80"	EP1DP6580	\$193	N/A	\$215

Order Code	
e.g.	EP1DP4860, 613
EP1DP	Dual height post
48	Height one
60	Height two
613	Silver

**Specification Information**  
Specify trim color.

**Application Notes**  
Dual height posts are used where panels of two different heights intersect.  
Bottom levelers on posts allow for up to 1½" vertical adjustment.  
Due to the variety of combinations possible, connector caps, shrouds and post covers must all be ordered separately.

**NOTE: EP1 & EP2 Panels and components are available in legacy colors only.**



**Triple Height Post**

W	D	H	MODEL #	P1	P2	P3
-	-	28"/40"/48"	EP1TP284048	\$193	N/A	\$215
-	-	28"/40"/53"	EP1TP284053	\$193	N/A	\$215
-	-	28"/40"/60"	EP1TP284060	\$193	N/A	\$215
-	-	28"/40"/65"	EP1TP284065	\$206	N/A	\$229
-	-	28"/40"/80"	EP1TP284080	\$230	N/A	\$253
-	-	28"/48"/53"	EP1TP284853	\$193	N/A	\$215
-	-	28"/48"/60"	EP1TP284860	\$193	N/A	\$215
-	-	28"/48"/65"	EP1TP284865	\$206	N/A	\$229
-	-	28"/48"/80"	EP1TP284880	\$230	N/A	\$253
-	-	28"/53"/60"	EP1TP285360	\$193	N/A	\$215
-	-	28"/53"/65"	EP1TP285365	\$205	N/A	\$227
-	-	28"/53"/80"	EP1TP285380	\$229	N/A	\$249
-	-	28"/60"/65"	EP1TP286065	\$206	N/A	\$229
-	-	28"/60"/80"	EP1TP286080	\$230	N/A	\$253
-	-	28"/65"/80"	EP1TP286580	\$230	N/A	\$253
-	-	40"/48"/53"	EP1TP404853	\$193	N/A	\$215
-	-	40"/48"/60"	EP1TP404860	\$193	N/A	\$215
-	-	40"/48"/65"	EP1TP404865	\$206	N/A	\$229
-	-	40"/48"/80"	EP1TP404880	\$230	N/A	\$253
-	-	40"/53"/60"	EP1TP405360	\$193	N/A	\$215
-	-	40"/53"/65"	EP1TP405365	\$205	N/A	\$227
-	-	40"/53"/80"	EP1TP405380	\$229	N/A	\$249
-	-	40"/60"/65"	EP1TP406065	\$206	N/A	\$229
-	-	40"/60"/80"	EP1TP406080	\$230	N/A	\$253
-	-	40"/65"/80"	EP1TP406580	\$230	N/A	\$253
-	-	48"/53"/60"	EP1TP485360	\$193	N/A	\$215
-	-	48"/53"/65"	EP1TP485365	\$205	N/A	\$227
-	-	48"/53"/80"	EP1TP485380	\$208	N/A	\$231
-	-	48"/60"/65"	EP1TP486065	\$206	N/A	\$229
-	-	48"/60"/80"	EP1TP486080	\$230	N/A	\$253
-	-	48"/65"/80"	EP1TP486580	\$230	N/A	\$253
-	-	53"/60"/65"	EP1TP536065	\$205	N/A	\$227
-	-	53"/60"/80"	EP1TP536080	\$207	N/A	\$230
-	-	53"/65"/80"	EP1TP536580	\$230	N/A	\$253
-	-	60"/65"/80"	EP1TP606580	\$230	N/A	\$253

Order Code	
e.g.	EP1TP406080, 113
EP1TP	Triple height post
40	Height one
60	Height two
80	Height three
113	Dark Grey trim

**Specification Information**  
Specify trim color.

**Application Notes**  
Triple height posts are used where 3 or 4 panels of three different heights intersect.  
Bottom levelers on posts allow for up to 1½" vertical adjustment.  
Due to the variety of combinations possible, connector caps, shrouds and post covers must all be ordered separately.

**NOTE: EP1 & EP2 Panels and components are available in legacy colors only.**

## Single Height Post



W	D	H	MODEL #	P1	P2	P3
-	-	28"	EP1P28	\$72	N/A	\$78
-	-	40"	EP1P40	\$73	N/A	\$80
-	-	48"	EP1P48	\$74	N/A	\$83
-	-	53"	EP1P53	\$76	N/A	\$84
-	-	60"	EP1P60	\$77	N/A	\$86
-	-	65"	EP1P65	\$78	N/A	\$87
-	-	80"	EP1P80	\$83	N/A	\$89

Order Code	
e.g.	EP1P48, 177
EP1P	Post
48	Height
117	Soft Grey trim

**Specification Information**

Specify trim color.

Panel connectors and shrouds must be order separately.

**Application Notes**

Bottom leveler on posts allow for up to 1½" of vertical adjustment.

**NOTE: EP1 & EP2 Panels and components are available in legacy colors only.**

# Generation 1

## Panel connectors and shrouds

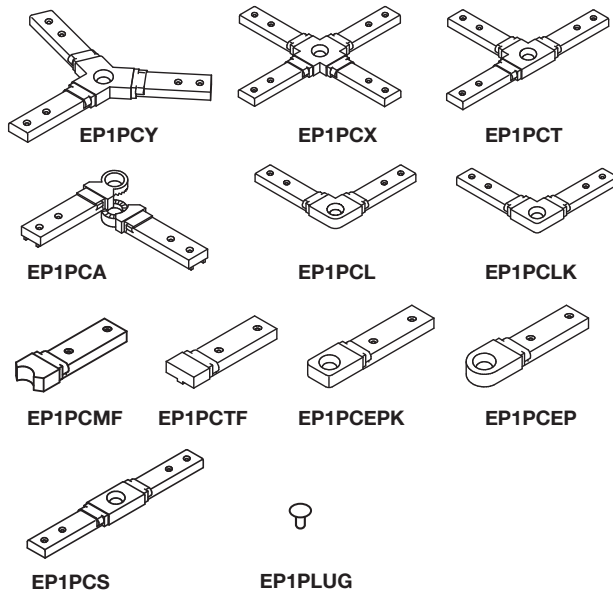

## Panel Connectors

TYPE	MODEL #	P1	P2	P3
End with post	<b>EP1PCEP</b>	\$36	\$38	\$39
End with post (for post covers)	<b>EP1PCEPK</b>	\$36	\$38	\$39
Four-way "X"	<b>EP1PCX</b>	\$52	\$56	\$62
Multi-height filler	<b>EP1PCMF</b>	\$26	\$28	\$29
Post plug (pkg. of 25)	<b>EP1PLUG</b>	\$17	\$23	\$24
Straight	<b>EP1PCS</b>	\$31	\$33	\$35
Three-way "T"	<b>EP1PCT</b>	\$47	\$49	\$52
Three-way "Y" 120°	<b>EP1PCY</b>	\$47	\$49	\$52
Trim filler	<b>EP1PCTF</b>	\$26	\$28	\$29
Two-way "L"	<b>EP1PCL</b>	\$39	\$40	\$41
Two-way "L" (for post covers)	<b>EP1PCLK</b>	\$39	\$40	\$41
Two-way adjustable angle	<b>EP1PCA</b>	\$49	\$56	\$56

## Raceway Shrouds

End with post	<b>EP1SEP</b>	\$49	N/A	\$56
End with post (for post covers)	<b>EP1SEPK</b>	\$49	N/A	\$56
Inside 120	<b>EP1SI120</b>	\$17	N/A	\$24
Outside "L"	<b>EP1SL</b>	\$36	N/A	\$39
Outside "L" (for post covers)	<b>EP1SLK</b>	\$36	N/A	\$39
Outside 120	<b>EP1SO120</b>	\$28	N/A	\$31
Outside 135	<b>EP1SO135</b>	\$28	N/A	\$31
Straight	<b>EP1SS</b>	\$26	N/A	\$29

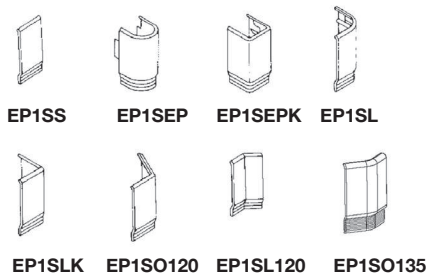

Order Code
e.g. <b>EP1SEP</b>
<b>EP1S</b> Post shroud
<b>EP</b> End with post

Specification Information
Specify panel connector and shroud trim color.
Specify one multi-height filler (EP1PCMF) for each low panel in a multi-height connection.
<b>NOTE: EP1 &amp; EP2 Panels and components are available in legacy colors only.</b>
<b>EXCEPTION: EP1 posts connectors only are available in all colors as they may need to be specified when ordering stack-on panels with an EP3 profile.</b>

Application Notes
Panel connectors stabilize panel to panel connections.
Panel connectors have painted finish and a quick mount design.
Mounting screws are included. Conical connector screw is included with post.
The EP1PCTF is a trim filler piece that is to be used when no other post part can be used in a given panel layout.
This piece butts against EP1PCS and EP1PCT, when installed as an addition.
Shrouds provide a finished raceway cover at posts. Two-way "L" connections do not require an inside shroud.



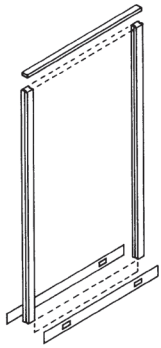

### Panel Extender Kit – 36" Wide

W	D	H	MODEL #	P1	P2	ADD FOR P3
36"	–	40"	EP1PE3640R	\$352	N/A	\$50
36"	–	48"	EP1PE3648R	\$392	N/A	\$50
36"	–	53"	EP1PE3653R	\$423	N/A	\$50
36"	–	60"	EP1PE3660R	\$451	N/A	\$50
36"	–	65"	EP1PE3665R	\$477	N/A	\$50
36"	–	80"	EP1PE3680R	\$553	N/A	\$50

### Panel Extender Kit – 40" Wide

48"	–	40"	EP1PE4840R	\$366	N/A	\$50
48"	–	48"	EP1PE4848R	\$408	N/A	\$50
48"	–	53"	EP1PE4853R	\$435	N/A	\$50
48"	–	60"	EP1PE4860R	\$469	N/A	\$50
48"	–	65"	EP1PE4865R	\$489	N/A	\$50
48"	–	80"	EP1PE4880R	\$569	N/A	\$50

### Panel Extender Kit – 60" Wide

60"	–	40"	EP1PE6040R	\$387	N/A	\$50
60"	–	48"	EP1PE6048R	\$423	N/A	\$50
60"	–	53"	EP1PE6053R	\$452	N/A	\$50
60"	–	60"	EP1PE6060R	\$485	N/A	\$50
60"	–	65"	EP1PE6065R	\$507	N/A	\$50
60"	–	80"	EP1PE6080R	\$582	N/A	\$50

Order Code	
e.g.	EP1PE6065R, 117
EP1PE	Raceway panel extender kit
60	Width in inches
65	Height
R	Raceway
117	Soft Grey trim

Specification Information	
Specify trim color.	
Jumpers to carry power through panel are ordered separately. With panel extender kits, add 3" to jumper length for each panel extender kit used.	

A kit designed to be field mounted onto panels to extend the width of the panel by 3" ( 1½" on each side). This adaption of the panel(s) will allow clearance when positioning existing freestanding equipment, i.e., files and desks, between side panels.

Application Notes
Kit contains two aluminum side extrusions, an extended top cap, extended baseboard covers, and installation hardware and instructions.
NOTE: EP1 & EP2 Panels and components are available in legacy colors only.

# Generation 3 Fabric Panel

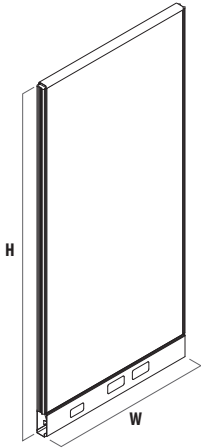

## 64" H

W	MODEL #	A	B	C	D	E	F	G	PAINT	
									P2	P3
12"	EP3FA1264(K/N)	\$660	\$710	\$770	\$850	\$970	\$1,100	\$1,250	+ \$25	+ \$50
18"	EP3FA1864(K/N)	\$710	\$760	\$820	\$900	\$1,020	\$1,150	\$1,300	+ \$25	+ \$50
24"	EP3FA2464(K/N)	\$760	\$810	\$870	\$950	\$1,070	\$1,200	\$1,350	+ \$25	+ \$50
30"	EP3FA3064(K/N)	\$810	\$860	\$920	\$1,000	\$1,120	\$1,250	\$1,400	+ \$25	+ \$50
36"	EP3FA3664(K/N)	\$890	\$1,000	\$1,130	\$1,290	\$1,540	\$1,820	\$2,140	+ \$25	+ \$50
42"	EP3FA4264(K/N)	\$940	\$1,050	\$1,180	\$1,340	\$1,590	\$1,870	\$2,190	+ \$25	+ \$50
48"	EP3FA4864(K/N)	\$990	\$1,100	\$1,230	\$1,390	\$1,640	\$1,920	\$2,240	+ \$25	+ \$50
60"	EP3FA6064(K/N)	\$1,080	\$1,190	\$1,320	\$1,480	\$1,730	\$2,010	\$2,330	+ \$25	+ \$50

		Top Cap	Panel Type	W	H	Raceway
EP	Equity panel	3 Beveled	FA Fabric panel	36	29	K With knockouts N Without knockouts
EP		3	FA	36	29	K

# Generation 3 Insert Panel

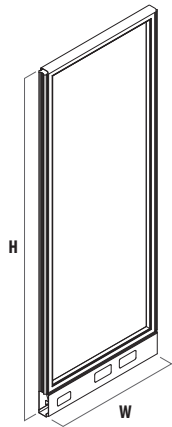

## 64" H

W	MODEL #	OPEN FRAME (OF)	PLEXIGLASS (PG)*	PAINT	
				P2	P3
12"	EP3( )1264(K/N)	\$797	\$1,147	+ \$25	+ \$50
18"	EP3( )1864(K/N)	\$807	\$1,267	+ \$25	+ \$50
24"	EP3( )2464(K/N)	\$817	\$1,397	+ \$25	+ \$50
30"	EP3( )3064(K/N)	\$837	\$1,497	+ \$25	+ \$50
36"	EP3( )3664(K/N)	\$857	\$1,597	+ \$25	+ \$50
42"	EP3( )4264(K/N)	\$877	\$1,697	+ \$25	+ \$50
48"	EP3( )4864(K/N)	\$897	\$1,797	+ \$25	+ \$50
60"	EP3( )6064(K/N)	\$947	\$1,997	+ \$25	+ \$50

Panel Type		W	H	Raceway	
EP3 Equity panel	OF Open frame PG Plexiglass insert	36	29	K With knockouts N Without knockouts	
EP	PG	36	29	K	

Pricing is for P1 paint trim colors. Add the appropriate upcharge if using P2 or P3 trim.

# Generation 3

## Post Assemblies

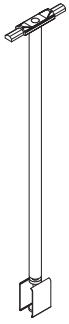

### Straight

H	MODEL #	PAINT		
		P1	P2	P3
64"	EP3P64S	\$157	\$165	\$172

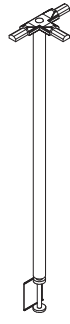

### 3-way T

H	MODEL #	PAINT		
		P1	P2	P3
64"	EP3P64T	\$152	\$159	\$166

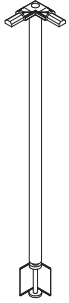

### 2-way L

H	MODEL #	PAINT		
		P1	P2	P3
64"	EP3P64L	\$152	\$159	\$166

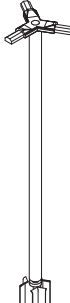

### 3-way 120

H	MODEL #	PAINT		
		P1	P2	P3
64"	EP3P64Y	\$190	\$201	\$208

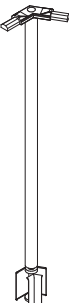

### 2-way 120

H	MODEL #	PAINT		
		P1	P2	P3
64"	EP3P64120	\$157	\$165	\$172

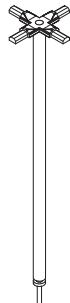

### 4-way X

H	MODEL #	PAINT		
		P1	P2	P3
64"	EP3P64X	\$132	\$141	\$147

#### Specify

1. Model #
2. Paint trim color

#### Application Notes

Used to connect panels of the same height

Bottom glides on post allow for up to 1 1/2" of vertical adjustment.

#### Assembly

- Included**
- Single height post
  - Panel connector
  - Appropriate metal shroud

#### Top Cap Style

3 – Beveled

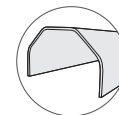

**Single Height**

H	MODEL #	PAINT		
		P1	P2	P3
64"	<b>EP3P64</b>	\$78	\$83	\$87

**Dual Height**

29"/64"	<b>EP3DP2964</b>	\$177	\$187	\$197
41"/64"	<b>EP3DP4164</b>	\$177	\$187	\$197
49"/64"	<b>EP3DP4964</b>	\$177	\$187	\$197
54"/64"	<b>EP3DP5464</b>	\$177	\$187	\$197
61"/64"	<b>EP3DP6164</b>	\$177	\$187	\$197
64"/81"	<b>EP3DP6481</b>	\$193	\$205	\$215

**Triple Height**

H	MODEL #	PAINT		
		P1	P2	P3
29"/41"/64"	<b>EP3TP294164</b>	\$208	\$220	\$232
29"/49"/64"	<b>EP3TP294964</b>	\$208	\$220	\$232
29"/54"/64"	<b>EP3TP295464</b>	\$208	\$220	\$232
29"/61"/64"	<b>EP3TP296164</b>	\$208	\$220	\$232
29"/64"/81"	<b>EP3TP296481</b>	\$230	\$239	\$250
41"/49"/64"	<b>EP3TP414964</b>	\$208	\$220	\$232
41"/54"/64"	<b>EP3TP415464</b>	\$208	\$220	\$232
41"/61"/64"	<b>EP3TP416164</b>	\$208	\$220	\$232
41"/64"/81"	<b>EP3TP416481</b>	\$230	\$239	\$250
49"/54"/64"	<b>EP3TP495464</b>	\$208	\$220	\$232
49"/61"/64"	<b>EP3TP496164</b>	\$208	\$220	\$232
49"/64"/81"	<b>EP3TP496481</b>	\$230	\$239	\$250
54"/61"/64"	<b>EP3TP546164</b>	\$208	\$220	\$232
54"/64"/81"	<b>EP3TP546481</b>	\$230	\$239	\$250
61"/64"/81"	<b>EP3TP616481</b>	\$230	\$239	\$250

EP3 Equity panel		P Post	H	Connection Type	
EP3	Equity panel	P	64	120 2-way 120	
				E End w/post	
				ETK Postless end	
				L 2-way L	
				T 3-way T	
				<b>S Straight</b>	
				X 4-way	
				Y 3-way 120	
				64	<b>S</b>

# End Kits



## End w/Post

H	MODEL #	PAINT		
		P1	P2	P3
64"	<b>EP3P64E</b>	\$186	\$193	\$200



## Postless End

H	MODEL #	PAINT		
		P1	P2	P3
29"	<b>EP3ETK29</b>	\$157	\$160	\$163
41"	<b>EP3ETK41</b>	\$159	\$162	\$165
49"	<b>EP3ETK49</b>	\$161	\$164	\$167
54"	<b>EP3ETK54</b>	\$163	\$166	\$169
61"	<b>EP3ETK61</b>	\$165	\$168	\$171
64"	<b>EP3ETK64</b>	\$167	\$170	\$173
66"	<b>EP3ETK66</b>	\$167	\$170	\$173
81"	<b>EP3ETK81</b>	\$176	\$179	\$182

## End w/Post

### Specify

1. Model #
2. Paint trim color

### Application Notes

Used to finish a panel end that is not being connected to another panel.

### Assembly

#### Included

- Single height post
- Panel connector
- Appropriate metal shroud

### Top Cap Styles

3 – Beveled

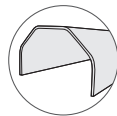

## Postless End

### Specify

1. Model #
2. Paint trim color

### Application Notes

Used to finish a panel end that is not being connected to another panel.

**NOTE: Postless end kit should not be used on panels that are placed perpendicular to a worksurface of the same depth as the front of the worksurface will extend approximately 3/4" beyond the panel end.**

### Assembly

#### Included

- Panel connector
- Appropriate metal shroud

### Top Cap Styles

3 – Beveled

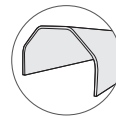



## Panel Wall Starter

W	D	H	H (Actual)	MODEL #	PAINT		
					P1	P2	P3
1 1/2"	1/2"	64"	60"	EP3PWS64	\$52	\$56	\$62



## Wall Mounted Channel

W	D	H	H (Actual)	MODEL #	P1	P2	P3
2 7/8"	3/4"	64"	60"	EP3WMC64	\$133	\$144	\$148

## Panel Wall Starter

### Specify

1. Model #
2. Paint trim color

### Application Notes

Used to start a run of panels by fastening to an existing wall and attaching a connector assembly to it. Creates 1 1/4" space from face to wall to centerline of post. Constructed of steel.

**NOTE: Neutral Posture assumes no responsibility for wall construction or performance of fasteners used.**

### Assembly

#### Included

- Panel top & bottom hook
- Panel connector

#### Not Included

- Fasteners to attach to wall

#### Ordered Separately

- Post
- Shrouds

### Top Cap Styles

3 – Beveled

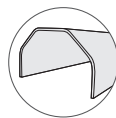

## Wall Mounted Channel

### Specify

1. Model #
2. Paint trim color

### Application Notes

Allows hanging of all components and accessories on reinforced building walls.

Painted extruded aluminum with a plastic insert which snaps in place, covering mounting screws.

**NOTE: Neutral Posture assumes no responsibility for wall construction or performance of fasteners used.**

### Assembly

#### Included

- Extruded aluminum channel
- Insert which snaps into place



### Vertical Wire Manager

W	D	H	MODEL #	P1	P2	P3
½"	¾"	80"	EC1VWM80	\$29	\$31	\$33



### Metal Ceiling Module

4"	1½"	120"	EE1CM40M	\$625	N/A	\$689
4"	1½"	120"	EE1CM48M	\$625	N/A	\$689
4"	1½"	120"	EE1CM53M	\$625	N/A	\$689
4"	1½"	120"	EE1CM60M	\$625	N/A	\$689
4"	1½"	120"	EE1CM65M	\$625	N/A	\$689
4"	1½"	120"	EE1CM80M	\$625	N/A	\$689

### Ceiling Infeeds – Generation 3

4"	1 ½"	120"	EE3CM64M	\$625	\$656	\$689
----	------	------	----------	-------	-------	-------

#### Order Code

e.g. EC1VWM80, 177

EC1VWM Vertical Wire Manager

80 Length

117 Soft Grey trim

#### Specification Information

Specify trim color.

#### Vertical Wire Manager:

A plastic strip designed to hide a cord running down the edge of the panel. Cut to desired length in field.

#### Ceiling Infeed Modules:

Electrical harnesses not included with modules. Modules are hollow to accommodate power and/or data cables from source into systems furniture.

With electrical harness installed, infeed holds 35 CAT 5 cables.

Cables/conduit are laid into the lower metal body by removal of the front 1-½" wide access cover and into the upper plastic extrusion

by separating the front edge of the pliable tube. Infeed module is attached to an available post location of the appropriate height. The module can not be used for panel support and there are no "hang on" capabilities. Includes escutcheon plate. Plate and plastic tube are white to integrate with standard ceiling color.

No "hang on" capabilities. Module cannot be used for panel support.

Painted metal module is 120" long metal extrusion with attachment hooks at proper height to attach to appropriate height post.

To connect a metal ceiling infeed to a corner or a straight connection you must use an adjustable angle connector or adjustable angle connector with a multi-height panel connector.





**EP1 Coat Hook (6/carton)**

W	D	H	MODEL #	P1	P2	P3
½"	¾"	5"	EP1CH	\$120	N/A	N/A



**Coat Hanger**

W	D	H	MODEL #	P1	P2	P3
17"	¾"	9¼"	EP1CHG	\$15	N/A	N/A



**Carpet Gripper (12 pack)**

W	D	H	MODEL #	P1	P2	P3
			EP1CG12	\$38	N/A	N/A



**EP3 Coat Hook Straight (5 pack)**

W	D	H	MODEL #	P1	P2	P3
½"	1⅜"	2⅜"	EP3MMCH (B/P)	\$141	N/A	N/A



**EP3 Coat Hook Postless End (5 pack)**

W	D	H	MODEL #	P1	P2	P3
1⅜"	¾"	2⅜"	EP3MMCHPE (R/L)(B/P)	\$141	N/A	N/A

Order Code	
e.g.	EP1CH, 117
EP1CH	Coat hook
117	Soft Grey trim

**Specification Information**

Specify trim color.

Coat Hook and Coat Hanger available only in Dark Neutral, Medium Grey, Soft Grey or Taupe.

**NOTE: EP1 & EP2 Panels and components are available in legacy colors only.**

**Application Notes**

**Coat Hanger**  
A plastic coat hanger available to hang on coat hook. EP1 Coat hook: Molded plastic hook hangs over EP1 panels to hold coats and hangers. Coat hook must hang over straight post location if being used w/EP3 panels. Carpet gripper:12 per package.

**EP3 Coat hook**  
Aluminum coat hook attaches to any exposed Equity vertical slot. There are two versions. The straight version will work on any Equity vertical slot except for those on an inside corner. The postless end version is handed and extends beyond the edge of a panel with a postless end. Hand is determined by which side of the panel the coat hook is installed on while facing the panel. Available in two colors; Black (B) or Matte Aluminum (P).

# Counter Caps, Straight

Generation 1 and Generation 2 profiles

## Straight

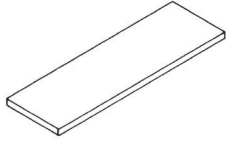

NOMINAL W	ACTUAL W	D	H	MODEL #	P1	P2	P3
12"	10.5"	15.25"	–	EW(1/2)1215	\$268	\$278	\$284
24"	22.5"	15.25"	–	EW(1/2)2415	\$297	\$303	\$311
30"	28.5"	15.25"	–	EW(1/2)3015	\$323	\$332	\$339
36"	34.5"	15.25"	–	EW(1/2)3615	\$323	\$332	\$339
42"	40.5"	15.25"	–	EW(1/2)4215	\$330	\$336	\$344
48"	46.5"	15.25"	–	EW(1/2)4815	\$333	\$341	\$348
60"	58.5"	15.25"	–	EW(1/2)6015	\$367	\$374	\$382
72"	70.5"	15.25"	–	EW(1/2)7215	\$387	\$392	\$402
84"	82.5"	15.25"	–	EW(1/2)8415	\$419	\$427	\$435
96"	94.5"	15.25"	–	EW(1/2)9615	\$435	\$444	\$451
108"	106.5"	15.25"	–	EW(1/2)10815	\$449	\$456	\$464
120"	118.5"	15.25"	–	EW(1/2)12015	\$500	\$506	\$513

## Straight – Extended One End

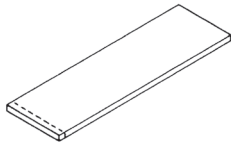

NOMINAL W	ACTUAL W	D	H	MODEL #	P1	P2	P3
12"	12"	15.25"	–	EW(1/2)1215E	\$279	\$286	\$296
24"	24"	15.25"	–	EW(1/2)2415E	\$305	\$314	\$322
30"	30"	15.25"	–	EW(1/2)3015E	\$329	\$334	\$342
36"	36"	15.25"	–	EW(1/2)3615E	\$329	\$334	\$342
42"	42"	15.25"	–	EW(1/2)4215E	\$336	\$344	\$351
48"	48"	15.25"	–	EW(1/2)4815E	\$347	\$353	\$361
60"	60"	15.25"	–	EW(1/2)6015E	\$373	\$380	\$388
72"	72"	15.25"	–	EW(1/2)7215E	\$405	\$410	\$418
84"	84"	15.25"	–	EW(1/2)8415E	\$422	\$430	\$438
96"	96"	15.25"	–	EW(1/2)9615E	\$441	\$448	\$455
108"	108"	15.25"	–	EW(1/2)10815E	\$473	\$481	\$489

## Straight – Extended Both Ends

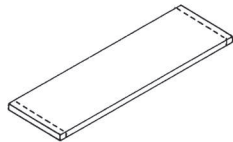

NOMINAL W	ACTUAL W	D	H	MODEL #	P1	P2	P3
12"	13.5"	15.25"	–	EW(1/2)1215EE	\$286	\$296	\$302
24"	25.5"	15.25"	–	EW(1/2)2415EE	\$319	\$325	\$333
30"	31.5"	15.25"	–	EW(1/2)3015EE	\$334	\$342	\$350
36"	37.5"	15.25"	–	EW(1/2)3615EE	\$334	\$342	\$350
42"	43.5"	15.25"	–	EW(1/2)4215EE	\$347	\$353	\$361
48"	49.5"	15.25"	–	EW(1/2)4815EE	\$387	\$392	\$402
60"	61.5"	15.25"	–	EW(1/2)6015EE	\$383	\$390	\$397
72"	73.5"	15.25"	–	EW(1/2)7215EE	\$413	\$420	\$428
84"	85.5"	15.25"	–	EW(1/2)8415EE	\$436	\$445	\$452
96"	97.5"	15.25"	–	EW(1/2)9615EE	\$449	\$456	\$464
108"	109.5"	15.25"	–	EW(1/2)10815EE	\$487	\$494	\$502

### Order Code

e.g.	EW16015,117, 117, 117
EW1	Worksurface
60	Width
15	Depth
117	Soft Grey laminate
117	Soft Grey edge
117	Soft Grey cantilever trim

### Specification Information

Specify surface, trim and cantilever trim color.

EW1 Counter caps work with all existing counter caps and are for use on Generation 1 or Generation 2 panels only. Plastic cantilevers are supplied.

EW2 counter caps are for use with Generation 3 panels only. Steel brackets are provided.

Counter caps are designed for mounting on top of panels.

Straight counter caps overhang both sides of the panel equally.

Counter caps fit between posts, appropriate to fit between two taller panels and a dual/triple height connectors.

A counter cap extension (E) covers one post.

A counter cap extension (EE) covers 2 posts.

Steel mounted brackets are supplied.

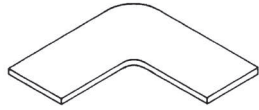

## Corner

W	D	H	MODEL #	P1	P2	P3
24"	15.25"	-	<b>EW(1/2)CC2415</b>	\$378	\$392	\$409
30"	15.25"	-	<b>EW(1/2)CC3015</b>	\$406	\$419	\$435
36"	15.25"	-	<b>EW(1/2)CC3615</b>	\$413	\$428	\$445

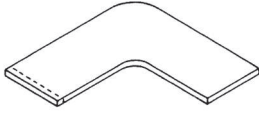

## Corner – Extended Left

24"	15.25"	-	<b>EW(1/2)CC2415LHE</b>	\$387	\$402	\$416
30"	15.25"	-	<b>EW(1/2)CC3015LHE</b>	\$413	\$428	\$445
36"	15.25"	-	<b>EW(1/2)CC3615LHE</b>	\$422	\$438	\$453

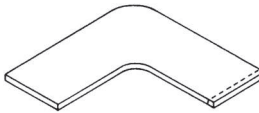

## Corner – Extended Right

24"	15.25"	-	<b>EW(1/2)CC2415RHE</b>	\$387	\$402	\$416
30"	15.25"	-	<b>EW(1/2)CC3015RHE</b>	\$413	\$428	\$445
36"	15.25"	-	<b>EW(1/2)CC3615RHE</b>	\$422	\$438	\$453

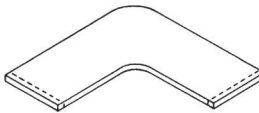

## Corner – Extended Both Ends

24"	15.25"	-	<b>EW(1/2)CC2415EE</b>	\$402	\$416	\$432
30"	15.25"	-	<b>EW(1/2)CC3015EE</b>	\$436	\$452	\$466
36"	15.25"	-	<b>EW(1/2)CC3615EE</b>	\$445	\$461	\$474

Order Code	
<b>e.g.</b>	<b>EW1CC3015, 117, 117</b>
<b>EW1</b>	Worksurface
<b>CC</b>	Curved corner
<b>30</b>	Width
<b>15</b>	Depth
<b>117</b>	Soft Grey laminate
<b>117</b>	Soft Grey edge
<b>117</b>	Soft Grey cantilever trim

Specification Information
Specify surface, trim and cantilever trim color.
EW1 counter caps work with all existing counter caps and are for use with Generation 1 or Generation 2 panels. Plastic cantilevers are supplied.
EW2 counter caps are for use with Generation 3 panels only.

Application Notes		
Counter caps are designed for mounting on top of panels.	They are non-handed and screw holes for the mounting brackets must be field-drilled.	A counter cap extension (E) covers one post.
Corner counter caps-(E) extended one end, mount on top of 24", 30" or 36" panels at 90° to each other.	Steel mounting brackets are supplied.	A counter cap extension (EE) covers 2 posts.

# Freestanding support components

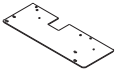

## Flat Brackets (black only)

W	D	H	TOP SIZE	MODEL #.	P1	P2	P3
	15"			EB1F24	\$45	n/a	n/a
	21"			EB1F30	\$52	n/a	n/a



## Column Base

		27 <sup>3</sup> / <sub>4</sub> "		EB1FCOL	\$320	\$348	\$362
--	--	----------------------------------	--	---------	-------	-------	-------

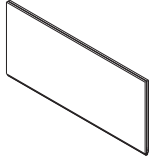

## Tackable Privacy

W	D	H	MODEL #.	A	B	C	D	E	F	G
36"	¾"	21"	<b>EF2PS36</b>	\$392	\$426	\$431	\$443	\$451	\$458	\$472
42"	¾"	21"	<b>EF2PS42</b>	\$411	\$443	\$452	\$467	\$473	\$483	\$495
48"	¾"	21"	<b>EF2PS48</b>	\$428	\$461	\$472	\$485	\$491	\$499	\$513
60"	¾"	21"	<b>EF2PS60</b>	\$459	\$497	\$507	\$519	\$529	\$536	\$553
72"	¾"	21"	<b>EF2PS72</b>	\$491	\$531	\$541	\$556	\$565	\$574	\$592

Order Code	
<b>e.g.</b>	EF2OS60, 117
<b>EF20S</b>	Equity freestanding privacy screen
<b>60</b>	Length in inches
<b>117</b>	Soft Grey trim

**Specification Information**

Specify shelf and stanchion trim color where required.

**NOTE: Fabric on 72" privacy screens and will be railroaded (turned 90°).**

---

## WALL MOUNTING SUGGESTIONS

---

The following information is provided only as a guide, and represents minimum recommendations only. Neutral Posture does not accept responsibility for the attachment of any Neutral Posture product to a Customer's site wall. Wall specification/construction is the responsibility of the Customer and its structural engineer/architect. Failure to properly attach Neutral Posture products to adequate wall structures can lead to property damage and/or personal injury.

You should consult your own structural engineers and/or architects and must not rely on the information provided herein.

It is the responsibility of the Customer and its structural engineers/architects to verify that the permanent structural walls (studs, blocks, solid masonry, etc.) on which the

Neutral Posture products are intended to be mounted are designed appropriately to support the product weight, PLUS 3 lbs. per linear inch for each usable shelf length.

NOTE: A cabinet's top is considered a "usable shelf" and MUST be included in the calculation of the total load for an overhead cabinet.

It is the responsibility of the Customer and its structural engineer/architects to specify the fasteners and method for attaching the Neutral Posture supplied wall mounting cleat, bracket, frame, etc. to the supporting wall and to confirm that the installers have adhered to these specifications. For all local building standards and codes, and additional requirements (including, but not limited to, seismic conditions) the Customer should always consult local code agencies.

## New Construction

## Existing Construction

	Cinder Block or Poured Concrete Masonry Wall	Wood Stud Wall, the studs being <b>FULL HEIGHT</b> to the roof/floor above	Wood Stud Wall, the studs being only ceiling height	Steel Stud Wall, the studs being <b>FULL HEIGHT</b> to the roof/floor above	Steel Stud Wall, the studs being only ceiling height	
<b>Stud Specification</b>	Wood studs, grade #2 or better, 3 1/2" minimum width, OR Metal studs, minimum 25 gage thickness, 3 5/8" minimum width	The wall must be a minimum of 6" thick, and must be full height to the roof/floor structure above	Wood studs must be Grade #2, or better, 3 1/2" minimum width	Wood studs must be Grade #2, or better, 3 1/2" minimum width	Metal studs must be minimum 25 gage thickness, 3 5/8" minimum width	
<b>Stud Centers</b>	Metal and wood studs must be spaced at 16" c/c maximum.	N/A	Wood studs must be spaced at 16" c/c maximum.	Wood studs must be spaced at 16" c/c maximum.	Metal studs must be spaced at 16" c/c maximum.	
<b>Stud Height</b>	Metal and wood studs must extend upwards, and be securely attached to the roof/floor structure above.			Wood studs must be braced above the ceiling, and be securely attached to the roof/floor structure above Affix #2 grade 'cap' across the top of the studs, then place diagonal studs from the top cap up to underside of the roof/floor structure above.		
<b>Mounting the Neutral Posture Supplied Cleat, Bracket, Frame, etc</b>	<p>Insert a 2" x 6" wood block, #2 grade or better, [or a locally approved flexible wood backing system] horizontally between each of the studs to accommodate the full width of the cabinet and beyond to the next stud.</p> <p>Fasten the wood block to each stud using three screws at the ends of each block.</p> <p>(Fasten the locally approved wood backing system as directed by the manufacturer.)</p> <p>Fasten the Neutral Posture supplied wall mounting cleat, bracket, frame, etc directly to each wood block every 6".</p> <p>For wall mounting structures that have a rectangular frame-like configuration: fasten the top horizontal element of the frame to the wood blocking every 6" and fasten the lower horizontal element to each wall stud, using one fastener per stud.</p>	<p>Fasten the Neutral Posture supplied cabinet wall mounting cleat, bracket, frame, etc. directly to the masonry wall every 6".</p> <p>For wall mounting structures that have a rectangular frame-like configuration: fasten the top horizontal element of the frame to the wall every 6" and fasten the lower horizontal element to the wall every 16".</p>	<p>In the desired location of the cabinet mounting rail, remove an 8" high section of drywall the width of the cabinet and beyond to the next stud.</p> <p>Insert a 2" x 6" wood block, #2 grade or better, horizontally between each of the exposed studs.</p> <p>Fasten the wood block to each stud using three screws at the ends of each block.</p> <p>Replace the drywall and repair as desired.</p> <p>Fasten the Neutral Posture supplied wall mounting cleat, rail, frame, etc directly to the wood block every 6".</p> <p>For wall mounting structures that have a rectangular frame-like configuration: fasten the top horizontal element of the frame to the wood blocking every 6", and fasten the lower horizontal element to each wall stud, using one fastener per stud.</p>	<p>In the desired location of the cabinet mounting rail, remove an 8" high section of drywall the width of the cabinet and beyond to the next stud.</p> <p>Insert a 2" x 6" wood block, #2 grade or better, horizontally between each of the exposed studs.</p> <p>Fasten the wood block to each stud using three screws at the ends of each block.</p> <p>Replace the drywall and repair as desired.</p> <p>Fasten the Neutral Posture supplied wall mounting cleat, rail, frame, etc directly to the wood block every 6".</p> <p>For wall mounting structures that have a rectangular frame-like configuration: fasten the top horizontal element of the frame to the wood blocking every 6", and fasten the lower horizontal element to each wall stud, using one fastener per stud.</p>	<p>In the desired location of the cabinet mounting rail, remove an 8" high section of drywall the width of the cabinet and beyond to the next stud.</p> <p>Insert a 2" x 6" wood block, #2 grade or better, [or a locally approved flexible wood backing system] horizontally between each of the exposed studs.</p> <p>Fasten the wood block to each stud using three screws at the ends of each block.</p> <p>Replace the drywall and repair as desired.</p> <p>Fasten the Neutral Posture supplied wall mounting cleat, rail, frame, etc directly to the wood block every 6".</p> <p>For wall mounting structures that have a rectangular frame-like configuration: fasten the top horizontal element of the frame to the wood blocking every 6", and fasten the lower horizontal element to each wall stud, using one fastener per stud.</p>	<p>In the desired location of the cabinet mounting rail, remove an 8" high section of drywall the width of the cabinet and beyond to the next stud.</p> <p>Insert a 2" x 6" wood block, #2 grade or better, [or a locally approved flexible wood backing system] horizontally between each of the exposed studs.</p> <p>Fasten the wood block to each stud using three screws at the ends of each block.</p> <p>Replace the drywall and repair as desired.</p> <p>Fasten the Neutral Posture supplied wall mounting cleat, rail, frame, etc directly to the wood block every 6".</p> <p>For wall mounting structures that have a rectangular frame-like configuration: fasten the top horizontal element of the frame to the wood blocking every 6" and fasten the lower horizontal element to each wall stud, using one fastener per stud.</p>
<b>Fasten the Neutral Posture Supplied Wall Cleat With...</b>	#10 x 2 1/2" wood screws or equiv. in every mounting hole provided, screwed directly into the wood blocking	3/16" x 3 1/2" masonry screws or equiv. in every mounting hole provided with 1 1/4" embedment, screwed directly into the masonry wall	#10 x 2 1/2" wood screws or equiv. in every mounting hole provided, screwed directly into the wood blocking	#10 x 2 1/2" wood screws or equiv. in every mounting hole provided, screwed directly into the wood blocking	#10 x 2 1/2" wood screws or equiv. in every mounting hole provided, screwed directly into the wood blocking	

# Key Lock Program

## GENERAL INFORMATION

Following is the Neutral Posture key lock policy, applicable to all products.

Neutral Posture pedestals, overheads, and storage cabinets ship without lock cores installed. The locks are field installed. If your purchase order does not specify key-alike you will automatically receive random lock cores with your order.

Neutral Posture furniture can be keyed-alike or random keyed.

### KEY-ALIKE

Furniture may be keyed alike at no charge. Write "key-alike" in the description of your purchase order for any storage piece you wish to have keyed alike.

Using the key-alike instructions, order cores and keys as line items on your purchase order. Neutral Posture will select key numbers from the standard range of 226 – 425. Key numbers will not be repeated unless over 199 sets are ordered.

There is no charge for key-alike orders if placed with the furniture order.

If product is ordered and shipped random-keyed, additional lock cores for key-alike are billable.

### KEYS

A key is shipped with every lock core. 199 Key numbers are available. For numbers above 199, contact Sales Support. Additional keys and key blanks are available.

### MASTER KEYING

Neutral Posture locks can be controlled by means of a master key. There is no additional per-lock charge for master keying. Master keys must be ordered separately.

### INSTALLING LOCK CORES

Lock cores can be installed or removed in the field by using a change key. Cores must be in the unlocked position to be removed. See service parts for change key pattern number and pricing.

### SERVICE PARTS

MODEL #	DESCRIPTION	LIST
NLCKE_ _ _	Shrouded Key ( <i>Specify key number desired</i> )	\$18
NAKC	Change Key	\$18
NKM	Master Key	\$18

**NOTE: A letter of approval on company letterhead from the client must accompany all orders for master keys.**

**NOTE: Neutral Posture locks/keys are not compatible with Knoll Equity pedestals/double pedestals.**

## HOW TO SPECIFY KEY-ALIKE

Following is an example of how to specify key-alike for a cluster of 10 workstations.

### STEP 1

Using the project floor plan, count the number of locks in each workstation.

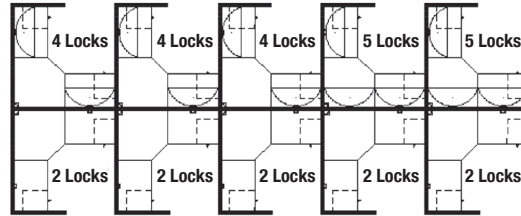

### STEP 2

Count the number of workstations with the same quantity of locks. Group together the workstations with a like number of locks.

5 workstations with 2 locks per station  
 3 workstations with 4 locks per station  
 2 workstations with 5 locks per station

### STEP 3

For the first group (5 sets of 2 locks), enter the number of workstations in the quantity column.

QTY	MODEL #	DESCRIPTION	UNIT LIST	EXT LIST
5	<b>NSPEC 2</b>	Set of 2 cores/keys	N / C	N / C

### STEP 4

Then enter the pattern number "NSPEC\_ \_" and add a suffix for the number of locks for that group (i.e., for 2 locks per station, add the suffix "2"). Up to 30 lock cores are available in a set (i.e., NSPEC 30).

QTY	MODEL #	DESCRIPTION	UNIT LIST	EXT LIST
5	<b>NSPEC 2</b>	Set of 2 cores/keys	N / C	N / C

### STEP 5

Repeat for other groups.

QTY	MODEL #	DESCRIPTION	UNIT LIST	EXT LIST
5	<b>NSPEC 2</b>	Set of 2 cores/keys	N / C	N / C
3	<b>NSPEC 4</b>	Set of 4 cores/keys	N / C	N / C
2	<b>NSPEC 5</b>	Set of 5 cores/keys	N / C	N / C

Your key instructions are complete.

Neutral Posture will select key numbers for each set from 199 available numbers.

For additions to existing installations, specify desired key numbers in the description.



## EQUITY

In order to specify an Equity locking component with an "H" series core, apply an "A" suffix to the Equity Base pattern number.

All keyed locks in the Equity system are randomly\* keyed, as a standard offering. For those requiring all locks within a workstation (or group of workstations) to be keyed alike, Equity also offers a key-alike option.

## EQUITY LOCKING COMPONENTS

Identify the cabinets to be keyed alike by adding the suffix "P" to the standard catalog number (i.e., EC20F36AP indicates a key-alike EC20F36A cabinet). The cabinet will be factory-prepared with the hardware mechanisms excluding the lock core and key. List price will be reduced by \$22.

## MULTIPLE KEY-ALIKE PACKAGES

For multiple keys of the same number, specify ALCKE - (number of keys desired, from 2 to 8.)  
 Price is: Number of Keys x \$22. (i.e.: ALCKE-5 Pkg. of five cores with keys = \$110.00)

## LOCK CORES

Order the lock cores required separately (ALCKE series). Cores are numbered sequentially, with up to 250 different combinations available (ALCKEH6001- ALCKEH6250). Use one line item for each quantity of lock cores to be keyed alike. Series H6001-H6100 are standard lead-time.

## MASTER KEY

A master key (AKM) is available that will unlock all cabinets and pedestals with the same prefix letter, for

example: H6001, H6002. A single key is supplied and priced, as shown below.

DESCRIPTION	CATALOG NUMBER	LIST
Equity Lock and Keys	<b>ALCKE(H6__)</b>	\$22
Change Key	<b>AKC</b>	18.
Master Key	<b>AKM</b>	18.

## SHIPMENT

Additional lead time of 2-4 weeks may apply when more than 100 lock sequences are specified for key-alike (contact Sales Support for current lead times).

The key-alike core and keys are shipped separately from the components for field installation in the appropriate workstation components.

\*Randomly keyed means that no attempt is made to assure that locks have the same number or that they are, in fact, different.

# NeutralPosture

Visit [NeutralPosture.com](https://NeutralPosture.com) or call 979.778.0502

BIFMA e3/LEVEL  
GSA

WOMEN<sup>™</sup>  
OWNED

ISO 9001:2015 Approved  
SCS Indoor Advantage